

SmartLVL 14/15 Design Guide



SmartLVL[®] 14/15 Design Guide

Scope of this publication

This Design Guide and Load Tables assist in the selection of SmartLVL[®] 14-15 beams for most of the common structural arrangements met in domestic construction.

Methods of developing lateral restraint and providing adequate support, adequate anchorage against wind uplift, and overall structural stability are outside the scope of this publication, however some limited examples have been reproduced within this document.

Information on the above matters can be obtained from AS 1684 Residential timber-framed construction or from a structural engineer experienced in timber construction.

Tilling Timber Pty Ltd have structural engineers at the Smart-Frame Design Centre who can be contacted for advice on matters concerning the use of its engineered timber products in timber construction at techsupport@tilling.com.au or on the Techsupport HelpLine 1300 668 690.

Substitution of other products

All load tables in this document are designed using in-grade tested properties of SmartLVL as distributed by Tilling Timber Pty Ltd. Other manufacturers' LVL may have different properties and therefore cannot be designed using these span tables.

Copyright

Copyright of this publication remains the property of Tilling Timber Pty Ltd, and reproduction of the whole or part of this publication without written permission from Tilling Timber Pty Ltd is prohibited.

Certification

As a professional engineer, qualified and experienced in timber engineering, I certify that the use of the SmartLVL members as shown in these tables, and installed in accordance with the provisions of this Design Guide, complies to the National Construction Code (NCC). These span tables have been prepared in accordance with standard engineering principles, the relevant test reports and Australian standards, ie:

- AS 1720.3 Design criteria for timber-framed residential buildings
- AS 1720.1 Timber structures - design methods
- AS 4055 Wind loads for houses
- AS/NZS 4357 Structural laminated veneer lumber
- AS/NZS 4063 Characterisation of structural timber

Craig Kay

CRAIG KAY, RPEng, RPB0730, EC-1961, RPEQ 5100, CC5635C, NER
National Product Engineer

INDEX

Scope of publication

1. SmartLVL

1.1 Design/effective span	1
1.2 Continuous spans	1
1.3 Rip sawing SmartLVL	1
1.4 Double section SmartLVL	
.1 top loaded beams	1
.2 side loaded beams	2
.3 side load table	2
1.5 Steel and timber post fixing	2
1.6 Fire resistance	2
1.7 Cutting and notching	3
1.8 Roof construction detailing	4
1.9 Lateral restraint of roof beams	4
1.10 Chemical resistance	5
1.11 Storage and handling	5
1.12 Durability and exposure to moisture	
.1 Moisture effects on LVL	6
.2 Dimensional change	6
.3 Changes in strength	6
.4 Design for durability	7
.5 Preservative treatment	7
.6 Fasteners for H3 LVL	7
.7 Painting of treated LVL	8
.8 Deck bearers and joists	8
1.13 SmartLVL Hanger details	9

2. Span Tables

Index of span tables	10
----------------------	----



The information contained in this product brochure is current as at Sept 2019 and is based on data available to Tilling Timber Pty Ltd at the time of going to print. Tilling Timber Pty Ltd has used its reasonable endeavours to ensure the accuracy and reliability of the information contained in this document and, to the extent permitted by law, will not be liable for any inaccuracies, omissions or errors in this information nor for any actions taken in reliance on this information. Tilling Timber Pty Ltd reserves the right to change the information contained in this document without prior notice. It is important that you call the techsupport Helpline on 1300 668 690 to confirm that you have the most up to date information available.

1. SmartLVL®

Description

SmartLVL is a structural Laminated Veneer Lumber (LVL) manufactured by toll manufacturers for Tilling Timber to meet the quality controlled process requirements of AS/NZS 4357 - Structural Laminated Veneer Lumber.



Quality

Compliance with process based quality control requirements is third party audited by SAI-Global, and the audits, together with end product testing is used as the basis for Product Certification by SAI-Global as a JAS-ANZ accredited Product Certification body.

JAS-ANZ stands for the government established "Joint Accreditation System of Australia and New Zealand" which exists as the peak organisation for accreditation of Product Certification bodies.



Preservative Treatment options

Stock SmartLVL is H2s (glue line) treated for use South of the Tropic of Capricorn. It can be post-production pressure treated to H2 or H3 to AS/NZS 1604.4.

Short term water repellency

SmartLVL comes with a clear **new generation** short term water repellency H₂O Shield™ to replace the old fashioned wax sealers used by most other LVL manufacturers. H₂O Shield™ is a water-based sealer specifically formulated and exclusively licensed in Australia to Tilling Timber Pty Ltd.

H₂O™ shield offers numerous key benefits:

- i) High-penetrating surface treatment
- ii) Formulated to repel rain during storage and construction
- iii) Includes a biocide/fungicide
- iv) Paintable - acrylic and oil based coatings
- v) Glueable – using standard construction adhesives between the LVL and wood or plaster products
- vi) When transporting or walking on the LVL, it does not become slippery like the wax surface coating
- vii) Environmentally friendly



Users will notice that the new sealer absorbs into the wood instead of leaving a film on top of the surfaces, which is the key to its added benefits.

1.1 SmartLVL Design/effective span

Normal structural analysis uses the centreline representation of the member. The term "span" can be defined in a number of ways and these are defined as follows:

Clear Span. This is the distance between the faces of any support. It is generally the one easiest to measure and read from the drawings

Nominal span/centre-line span. This is the distance between the centre of the supports. This span is used to determine bending moments and deflections for continuous spanning members

Design span/Effective span. This is the span used for single span members to determine the bending moment, the slenderness of bending members and the deflections. In NZS 3603 this is the dimension referred to as "L", and is defined below.

Design span/Effective span is the distance between -

- The centre of the bearing at each end of a beam where the bearing lengths have NOT been conservatively sized
- The centre of notional bearing that have been sized appropriately, where the size of the bearing IS conservative.

Diagram (a) shows beam where bearings have been designed appropriately. The effective span is taken as the distance between the centre of each bearing area

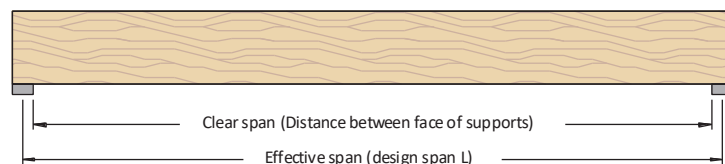
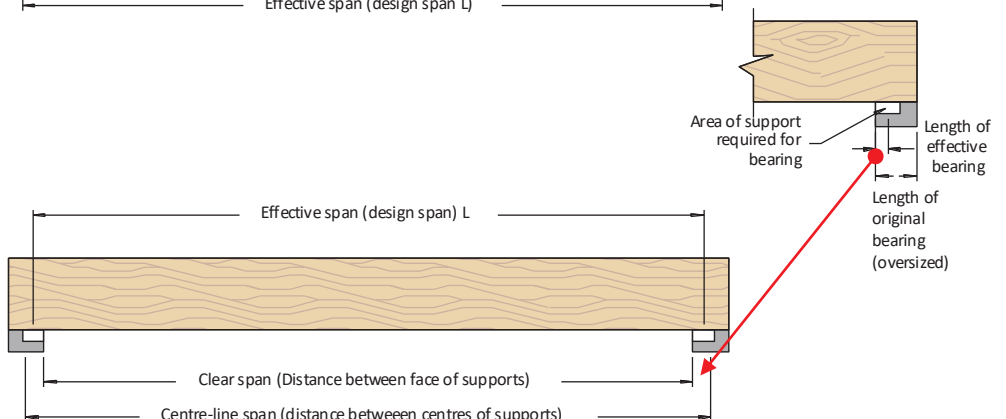

Diagram (b) shows beam where bearings at each end have been oversized. (This is frequently the case for beams that bear onto brickwork or concrete walls where the thickness of the wall is in excess of the area required to give the beam bearing capacity). To find the correct effective span:

1. Calculate the minimum bearing required to carry the loads satisfactorily
2. Add minimum bearing length to "clear span" distance.



1.2 Continuous spans

For beams continuous over two (2) unequal spans, the design span and the "Resultant Span Description" depend upon the percentage difference between the two spans as shown below:

Span Difference %	Effective span	Resultant span Description
10% max	Main span	Continuous
10 - 30%	1.1 x Main span	Continuous
above 30%	Main span	Single

$$\text{span difference} = \frac{(\text{main span} - \text{second span})}{(\text{main span} + \text{second span})} \times 100$$

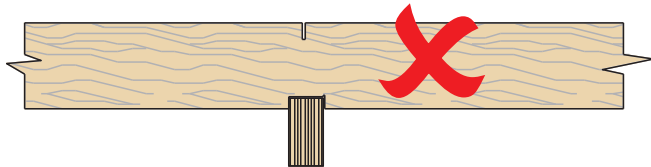
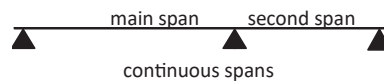

1.3 Rip sawing SmartLVL

One of the unique properties of Smart LVL is that it may be ripped through the depth to the smaller section sizes as those given in these span tables without affecting the basic strength properties. It is important that the new members are not cut undersized if the maximum spans in these tables are to be used.



The sawing through the thickness to produce sections of a lesser thickness may decrease the integrity of the SmartLVL and is therefore NOT recommended under any circumstances.



1.4 Double SmartLVL section beams

Beams of 70, 84 and 116 mm thickness can be formed by nail laminating two sections of SmartLVL as follows.

The suggested method of vertical lamination below provides a greater level of fixity between individual components, and with the use of an elastomeric adhesive, also prevents moisture penetration between the laminates.

Beam thickness (mm)	Individual section thickness (mm)	Nail Ø (mm)	Minimum nail length (mm)
70	35	3.06	75
84	42	3.30	90
116	58	3.30	100

Designers wishing to create double section 75 and 82 mm beams should seek advice from an experienced Engineer or from the techsupport Helpline on 1300 668 690.

Note, for continuous spans, the Design Span is taken as the distance between the centre of the supports, as shown in "Design Span" on page 1 of the Design Guide.

1.4.1 Multiple member laminating of top loaded beams

(Symmetrical loading)

The edges of the individual sections must be carefully aligned to each other so that the composite beam is flat, allowing the applied loads to be equally shared.

- Depths up to and including 300 mm: 2 rows of nails as shown above at 300 mm centre
- Depths in excess of 300 mm: 3 rows of nails as shown above at 300 mm centres

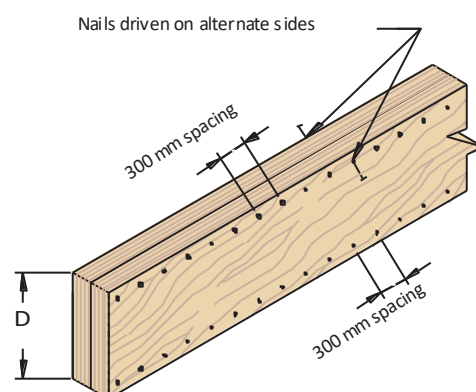
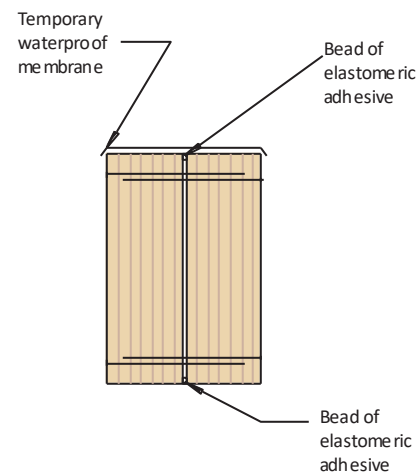

Recommended "during construction" protection from weather for multiple SmartLVL's.

1.4.2 Multiple member laminating of side loaded beams (Non-symmetrical loading)

Maximum floor load width by either outside member (mm)

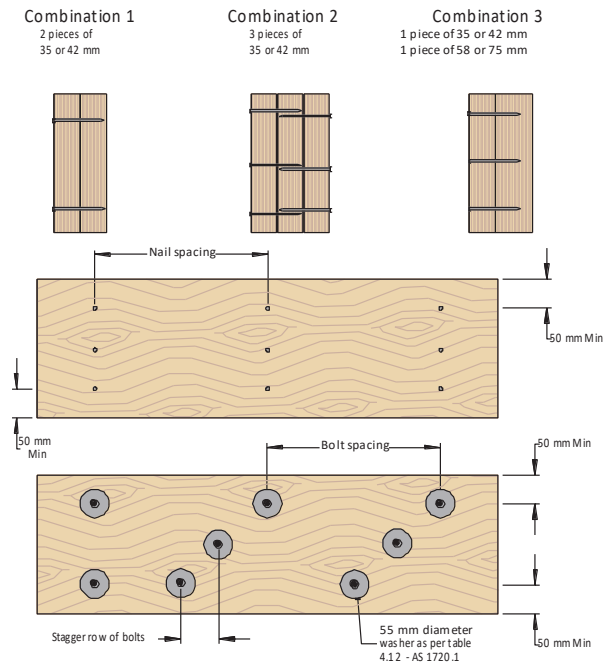

Combination (see details below)	3.75Φ x 90 mm nails		12 mm Φ bolts	
	2 rows at 300 ctrs	3 rows at 300 ctrs	2 rows at 600 ctrs	2 rows at 300 ctrs
Combination 1 (2/35)	2400	3700	6000	12000
Combination 1 (2/42)	2600	4000	7000	14000
Combination 1 (2/58)	1400	2200	9000	18000
Combination 2 (3/35)	6000	6000	6000	12000
Combination 2 (3/42)	2600	4000	7000	14000
Combination 2 (3/58)	1400	2200	10000	20000
Combination 3 (35+42)	2400	3700	6000	12000
Combination 3 (42+58)	2200	3300	7000	14000
Combination 3 (58+75)	1100	1700	9000	18000

Notes:

- Table values are for 40 kg/m² floors.
- The table values for nails may be doubled for nails at 150 mm centres, and tripled for nails at 100 mm centres
- The nail schedules shown apply to both sides of a three (3) piece beam
- Bolts are to be grade 4.6 commercial bolts. Bolt holes are to be a maximum of 13 mm diameter and are to be located NOT less than 50 mm from either edge.
- All bolts shall be fitted with a washer at each end, of a size NOT less than that given in AS 1720.1 table 4.12.

1.4.3 How to use the maximum uniform side load table

Example: see diagram below

Beam of 2/35 mm SmartLVL loaded on both sides (Combination 1)
 FLW 1 = 2800 mm, FLW 2 = 2300 mm
 Total FLW = 2800 + 2300 = 5100 mm.

- Use SmartLVL safe load tables to size the two member section to support the FLW of 5100 mm.
- Choose the larger of the side FLW's carried by the beam, in this case 2800 mm.
- Enter the table at the "Combination 1" row and scan across to a table value greater than 2800 mm. The second column in the row at 3700 mm is greater than the 2800 mm required, thus adopt 3 rows of 3.75Φ x 90 mm nails at 300 mm centres

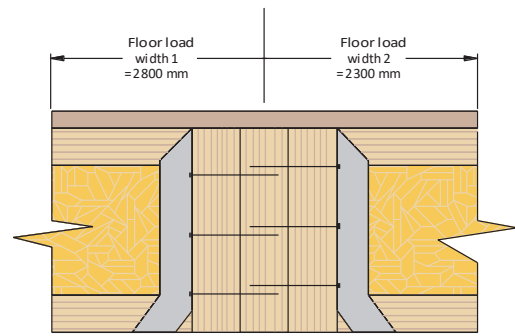

1.5 Steel and timber post fixing to SmartLVL

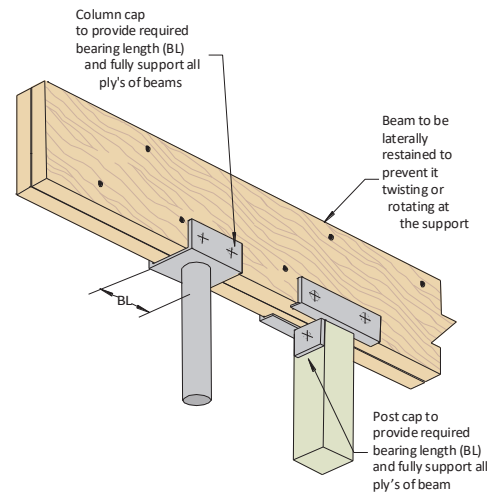

1.6 Fire resistance

The Fire Resistance Level (FRL) is the performance criteria for fire resistance, i.e. the grading periods (in minutes) for the following criteria as specified in the BCA:

- Structural adequacy (the duration for which the elements can carry its designated load)
- Integrity: (the duration for which the element can maintain its integrity to prevent the spread of fire to/from the compartment)

and

- Insulation (the duration for which the element is insulating the adjacent space from excessive temperature rise)

and is expressed in that order e.g. 30/30/30. The method for determining the structural component of the Fire Resistance Period for timber (including LVL and Glulam) is laid out in AS 1720.4

$$c = 0.4 + \left(\frac{280}{\delta} \right)^2$$

where:

c = notional charring rate, in mm per minute
 δ = timber density of SmartLVL 14/15 - 610 kg/m³

Further information on this topic including Design Guides relating to fire safety provisions can be obtained from the Wood Solutions website at www.woodsolutions.com.au.

For building in bushfire prone areas, a separate fully impregnated fire resistant SmartLVL FR SaferWood™ is now available within the SmartFrame family of EWP which can be used up to BAL 29. Stock sizes and lengths of SmartLVL FR SaferWood™ are currently limited but all sizes can be purchased as a special order.

For further information download the SmartLVL FR SaferWood™ Design Guide from www.tilling.com.au or contact SmartFrame Design on 1300 668 690.

1.7 Cutting and notching SmartLVL Beams, Bearers, Rafters and Joists (as per AS 1684.2)

Cutting, notching and drilling recommendations below are reproduced from AS 1684.2:2010 and therefore apply ONLY to components within buildings that fit within the building type and geometric limitations of that standard.

The cutting, notching and drilling of components within structures that do not meet the criteria of AS 1684.2:2010 is outside the scope of this document and should be referred to an experienced timber engineer or to the techsupport Helpline on 1300 668 690.

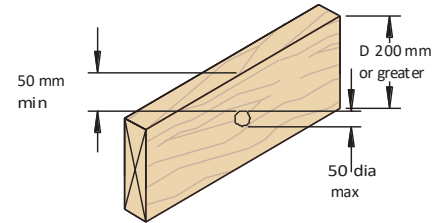
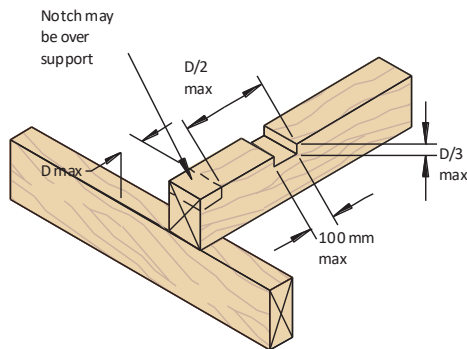
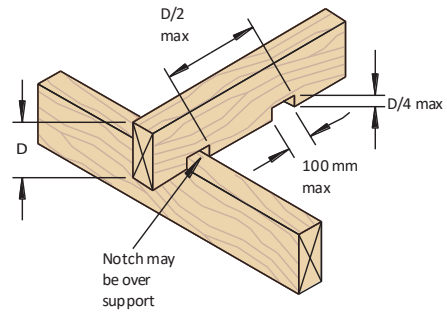
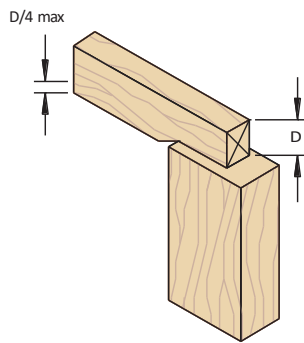
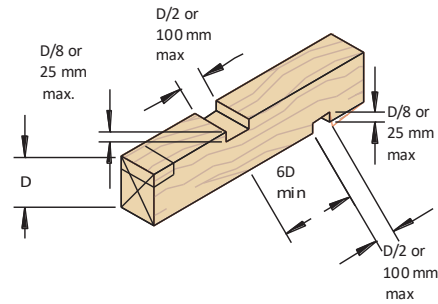
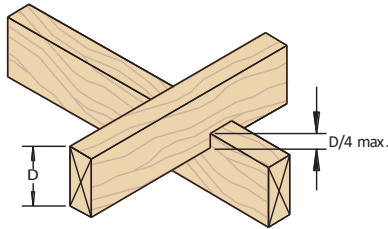

NOTE: Not more than 1 hole per 1800 mm of span

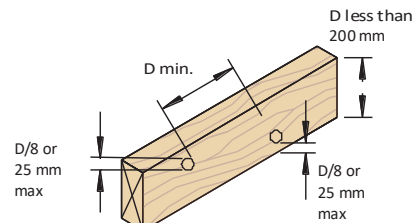
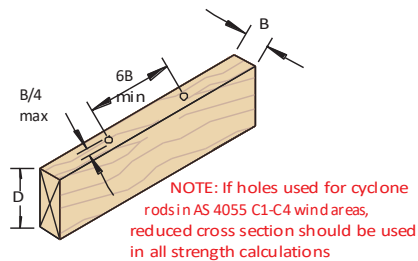

NOTE: Not more than 3 holes per 1800 mm of span

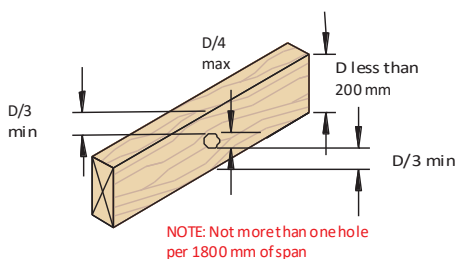

1.8 Roof construction detailing

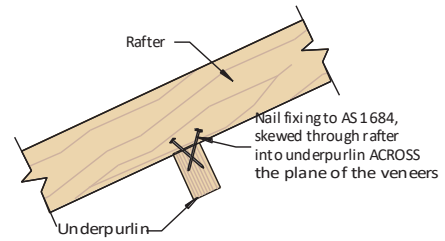
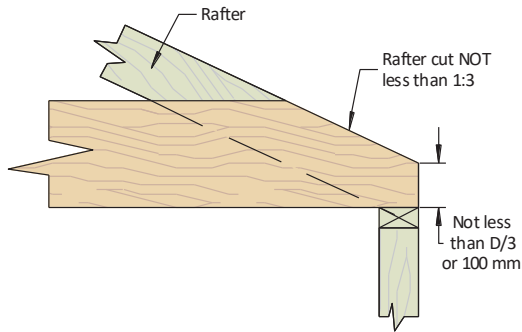

Rafters are NOT to be skew nailed to the underpurlin - with the nails parallel to the direction of the veneers

Rafter cut detail - applies ONLY to Counter, Hanging and Strutting beams.

Rafter underpurlin fixing

Vertical SmartLVL roof struts

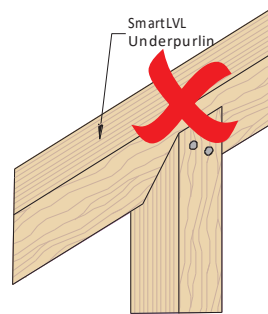
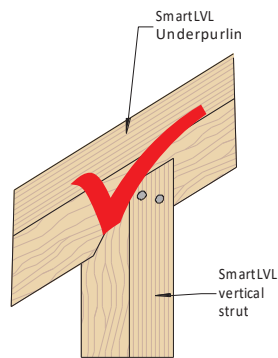

DO NOT cut the birdsmouth in the direction of the SmartLVL veneers

1.9 Lateral restraint of Hanging, Counter, Strutting, Strutting/hanging beams, Strutting/counter beams

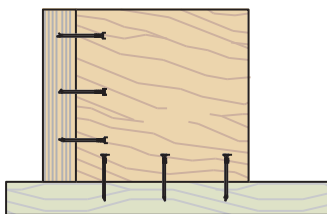

(a) Block skew nailed to beam and to support with 3/75 mm skew nails to each member.

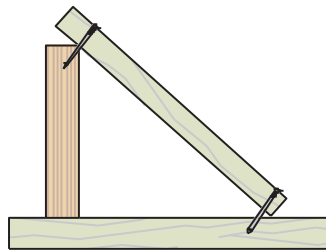

(b) Min 35 x 32 mm tie nailed to top of beam and to support with 2/75 mm nails at each end.

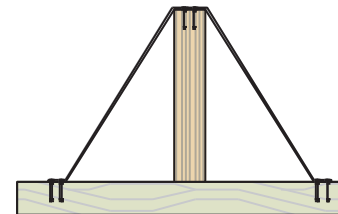

(c) Galvanised strap nailed to support and top of beam with 2/30 x 2.8 mm nails each end and to beam.

Notes:

- Method used depends upon whether ceiling joists are perpendicular or parallel to the beam.
- Methods given in (b) and (c) are particularly suitable for restraining strutting beams and strutting/hanging beams at the intermediate points where the beams are supported, as they also permit these beams to be supported up clear of the ceiling joists by packing under at their supports.

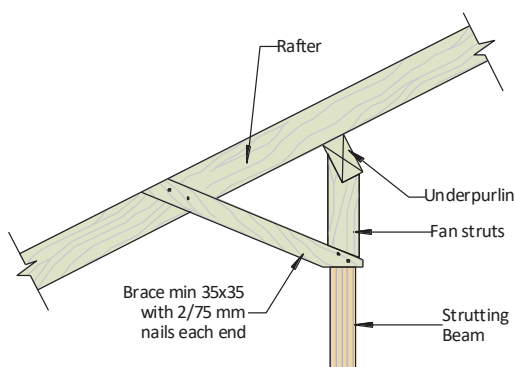

Example intermediate lateral restraints

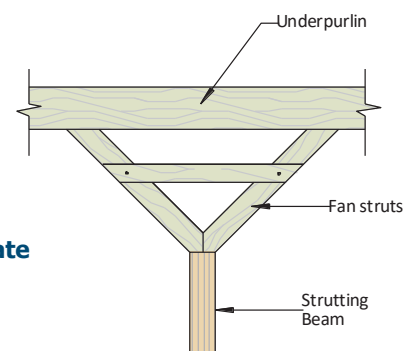

1.10 Chemical resistance

SmartLVL (wood in general) has a definite advantage over steel members when exposed to corrosive environments. Timber and wood products are able to withstand mild acid conditions and are more resistant to degradation.

The behaviour of SmartLVL in chemical environments depends upon a number of factors, including PH and temperature. Wood essentially responds by either swelling (Category S), similar to moisture response, or by chemical degradation (Category D). Damage due to swelling is essentially reversible, but chemical degradation results in breakdown of the wood structure and is non-reversible. Category S agents include alcohol and other polar agents. These agents swell dry wood causing a strength (and stiffness) loss proportional to the swelling.

Category D agents include acids, alkalis and salts and result in a loss of strength and stiffness directly related to the loss of member cross-section. The table below provides a rough guide to performance of SmartLVL in chemical environments.

The effect of chemicals on wood will generally be worsened by increased exposure time, temperature, extremes of pH and chemical concentration. Wood generally offers considerably less resistance to alkalis than acids. Softwoods (includes SmartLVL) generally have better resistance to acids than hardwoods.

Where there is the possibility of chemical attack on SmartLVL members, designers should seek expert advice.

Agent category	Chemical agent	Mode of attack	Damage - reversible or permanent	Severity - (loss of strength and/or stiffness)
Neutral	Non-polar liquids such as petroleum hydrocarbons	None	Negligible	Negligible
S (swelling)	Alcohol and other polar solvents	Swelling	Reversible	Proportional to volumetric swelling
D (degrading)	Inorganic acids	Hydrolysis of cellulose	Permanent	Slight to moderate
D	Organic acids such as: Formic, acetic, propionic and lactic acid	Hydrolysis of cellulose	Permanent	Slight (pH 3-6)
D	Alkalis such as: sodium, calcium and magnesium hydroxide	De-lignification of wood and dissolving of hemicellulose	Permanent	Moderate (pH > 9.5) Severe (pH > 11)
D	Salts (considered as weak acids)	Hydrolysis of cellulose	Permanent	Slight

Table reference Williamson T.G. 2002 APA Engineered Wood Handbook

1.11 Storage and handling of SmartLVL

- Store SmartLVL flat on a hard, dry surface
- If surface isn't paved, the ground should be covered with a polythene film
- Keep covered with waterproof material that allows bundles to "breathe"
- Use bearers (bolsters) between the ground and the first bundle (4 metre max spacing)
- Use 100 x 50 timber flat between bundles at same spacing as bolsters
- Take great care to rewrap remaining material after opening bundles
- LVL "grows" in thickness and depth when allowed to get wet....KEEP DRY!
- LVL with high MC has short term reduction in Characteristic Strengths KEEP DRY!
- Under NO circumstances is stored SmartLVL to be in contact with the ground.

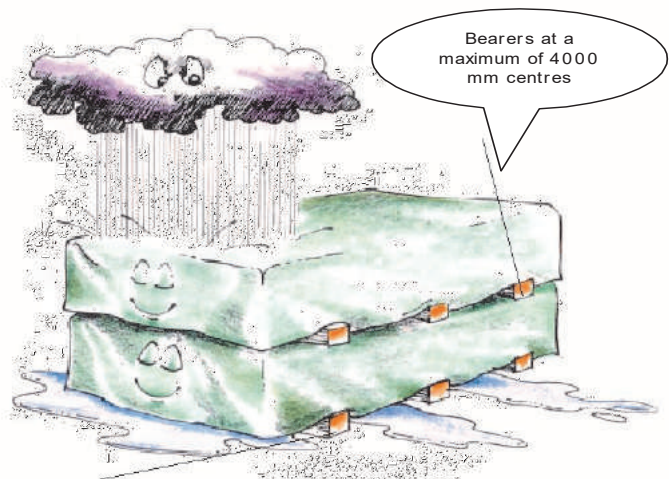

Use bearers to keep stacked material away from damp surfaces. Align bearer vertically

1.12 Durability and exposure to moisture

SmartLVL is manufactured from softwood veneers which have a durability rating of class 4, which is the same rating as some Ash type Eucalypts. Untreated SmartLVL should not be used where the equilibrium moisture content is likely to remain above 20% for an extended period.

Untreated SmartLVL is suitable in the **internal, fully protected, ventilated** and the **external above ground, protected** zones of the structure as shown below. Untreated SmartLVL is not suitable for **external above ground, exposed** or humid indoor conditions, such as swimming pool enclosures.

Definitions of exposure zones within a structure

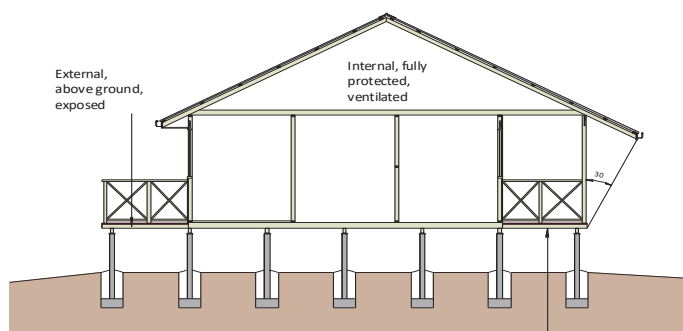

External timbers are regarded as protected in AS 1684 if they are covered by a roof projection (or similar) at 30° to the vertical and they are well detailed and maintained (painted and kept well ventilated).

1.12.1 Moisture effects on LVL

SmartLVL, like all wood products, is hygroscopic, which means it has an affinity for water, and being a LVL, should be considered as a composite of many pieces of wood, each with different potential swelling. Moisture exposure will ultimately lead to dimensional change.

SmartLVL is supplied WITH a new generation short term construction water repellent (H₂O Shield™) and once framed into a structure may be exposed to the weather for a limited time (usually not greater than 3 months) without negative affect, BUT, it may exhibit some effects of this exposure such as swelling and checking (especially at cut ends), depending upon the weather conditions.

While offering significant water short term repellency comparable to wax coatings, the H₂O Shield™ does NOT totally WATER PROOF the LVL. While the products will withstand normal exposure, excessive exposure during distribution, storage or construction may lead to dimensional changes that affect serviceability. These changes include cupping, bowing or expansion to dimensions to beyond the specified tolerance of the product in the “as-manufactured” condition.

Individual members of a vertically laminated multi member may exhibit some cupping if water becomes trapped between the laminates. This cupping produces more of a visual and possible fixity problem rather than being structurally significant. If not properly dried out, this moisture between laminated members may lead to decay. To prevent this effect, use construction details as shown on page 2.

As an organic material, mould and mildew may grow on untreated wood products if moisture is present. Prolonged periods of high moisture may also support the growth of wood decay fungi. The H₂O Shield™ does provide some resistance to mould and fungi attack, but it is NOT equivalent to H3 treatment. In critical applications where dimensional change due to moisture

exposure is to be absolutely minimised (e.g. truss applications in wet humid conditions) it is recommended that the remedial H₂O shield available from Tilling Timber in spray cans (or bulk for air-less spray guns) be used to recoat any cut ends or notches etc.

The table below shows the moisture content of LVL as a function of humidity.

Moisture content of wood products % ⁽¹⁾	
Relative Humidity %	LVL MC
10	1.2
20	2.8
30	4.6
40	5.8
50	7.0
60	8.4
70	11.1
80	15.3
90	19.4

1. Approx. moisture content at 21°C

1.12.2 Dimensional change

SmartLVL will shrink and swell in proportion to changes in moisture content between 0 and 28 % fibre saturation point.

The most significant moisture movement will occur across the grain (tangential and radial directions within a log). Longitudinal (movement in the grain direction) may be a factor depending upon the type of structure. Detailing of SmartLVL to be used where moisture contents will cycle should allow for dimensional instability.

The AVERAGE amount of dimensional change in a piece of LVL changes in moisture content can be APPROXIMATED by the following formula:

$$\Delta D = D_1 S (MC_f - MC_i) / FSP$$

Where:

ΔD = change in dimension

D₁ = Initial dimension

S = Shrinkage coefficient = approximately 6%

MC_i = Initial moisture content

MC_f = final moisture content

FSP = fibre saturation point approximately 28%

HOWEVER, these dimensional effects are quite variable. Thickness swell in LVL is erratic along the length because of the densification of the lap joints during manufacture tends to “relieve” when saturated and the total swell in sections containing two (2) laps can be as much as 3 mm.

1.12.3 Change in characteristic strengths

Changes in moisture content in wood results in changes in mechanical properties, with higher properties at lower moisture contents. Estimates of the effect of moisture differentials on the properties of clear wood may be obtained by the following equation:

$$P = P_{12} \left(\frac{P_{12}}{P_g} \right)^{\left(\frac{12 - M}{M_p - 12} \right)}$$

Where:

P = Characteristic property at moisture content

P₁₂ = same Characteristic property at 12% moisture content

P_g = same Characteristic property for Green wood

M_p = Intersection moisture content = 24% for Doug Fir

1.12 Durability and exposure to moisture (Cont'd)

The APPROXIMATE affect upon key Characteristic Properties of LVL by changes in MC are outlined in the table below:

Characteristic Property		Reduction in Characteristic strength at % MC					
		14	16	18	20	22	24
MOE (Stiffness)	E	3.3	6.5	9.7	12.7	15.6	18.4
MOR (Bending)	F _b	8.4	16.1	23.1	29.6	35.5	40.9
Compression perpendicular to grain	f _p	9.9	18.9	27.0	34.2	40.8	46.7
Compression parallel to grain	f _c	11.0	20.7	29.4	37.2	44.1	50.2
Shear	f _s	6.6	12.8	18.6	24.0	29.0	33.7

The design Characteristic properties of SmartLVL can therefore be considerably reduced by severe increase in MC of the LVL.

If the SmartLVL is being built into structures (such as Prefabricated trusses) that are:

1. Likely to experience large increase in MC due to weather exposure or stored on the ground
2. Likely to be loaded to at/or close to design loads while in the high MC state

then the reduced Characteristic Strengths as detailed above NEED to be used in the design or members may require temporary propping.

Once covered, the SmartLVL will ultimately dry and re-equilibrate to the ambient humidity conditions, but some expansion or swelling will remain after re-drying. The thickness swelling in laps will never fully shrink back and a large piece of LVL can have a final thickness variation along the length of 3-4 mm

1.12.4 Design for durability

- i. The use of building overhangs and other structures which protect the beams from excessive moisture movement and sun exposure.
- ii. All beams should be provided with adequate ventilation so that moisture content within beams will not exceed 15% and moisture gradients across the beam will not occur.
- iii. The use of arrised or round edges on beams to reduce the likelihood of coating failures on sharp edges.
- iv. The use of drip edges or other devices which provide a path for free moisture flow away from the timber beam.
- v. Joint detailing should, wherever possible, comply with the following:
 1. Keep horizontal contact areas to a minimum, in favour of self draining vertical surfaces.
 2. Ventilate joint surfaces by using spacers, wherever possible
 3. Always use compatible fasteners which have adequate corrosion protection and do not cause splitting during installation e.g. hot dipped galvanic coatings or stainless steel
 4. Ensure any moisture entering a joint is not trapped but can adequately drain away from the joint.

Allow for thermal expansion/contraction in the joint design.

1.12.5 Post-Production treatment

SmartLVL is supplied glue-line H2S* treated or can be supplied either LOSP treated or Tru-Core® treated to either H2 or H3 haz-

ard class levels, as per AS/NZS 1604.4. (Tru-Core® is a registered trade mark of Kop-Coat Australia PTY Limited)

To maintain effective treatment it is a requirement that any cuts, notches or penetrations made in post production treated LVL be painted with a suitable "brush/spray on" preservative.

The hazard class number selected is based upon the specific exposure condition for the proposed end use of the SmartLVL, as shown in the table below.

Hazard class selection guide				
Hazard class	Exposure	Specific service conditions	Biological hazard	Typical uses
H1 [†]	Inside, above ground	Completely protected from the weather and well ventilated, and protected from termites	Lyctid borers	Interior beams, staircases, stringers
H2S*	Inside, above ground	Protected from wetting Nil leaching	Borers and termites	Interior beams, staircases, trusses, joists
H2	Inside, above ground	Protected from wetting Nil leaching	Borers and termites	Interior beams, staircases, trusses, joists
H3	External, above ground	Subject to periodic moderate wetting and leaching	Moderate decay, borers and termites	Exterior beams ⁽¹⁾

[†] The timber species in SmartLVL are not susceptible to Lyctid Borer attack

* H2S treatment is only suitable South of the Tropic of Capricorn

A more comprehensive Hazard Class Table is available in AS/NZS 1604.4, but it is **NOT** recommended that SmartLVL be used in end uses with exposures requiring treatment in excess of H3.

(1) Experience is showing that post production treated LVL in the **external above ground, exposed** (H3 Hazard Class) may experience some leaching of the active ingredients of the treatment. To minimise the possibility of timber degradation in these situations, it is recommended that H3 treated Smart LVL NOT be used where the surface is horizontally exposed AND unprotected from water entrapment OR where post-treatment protection cannot be maintained.

Post treatment protection may include:

- (i) Protectadeck™ high density water proof joist/ bearer cover or malthoid capping
- and**
- (ii) An impervious membrane such as regularly maintained painting or staining
 - (iii) Construction detailing to prevent water entrapment.

H3 treated SmartLVL is NOT recommended for fascia's, pergolas or other similar **external above ground, exposed** applications due to mechanical degradation of the wood fibre causing checking and cracking which is both aesthetically unacceptable and allows ingress of water to inner veneers.

1.12.6 Fasteners for H3 LVL

For any H3 Smart LVL to be used in exposed exterior applications, it is recommended that either hot dipped galvanised or stainless steel fasteners are used.

1.12 Durability and exposure to moisture (Cont'd)

Specifically, If the Tru-Core® Copper Quat H3 treatment process is used, high grades (304, 305 and 316) of stainless steel materials perform the best.

1.12.7 Painting of treated SmartLVL

1. General

To provide the longest service life of the SmartLVL it is recommended the LVL is painted with an exterior paint with a Light Reflectance Value (LRV) greater than 30%. Heat reduction exterior paints should be used where the desired colour is dark or has a LRV of less than 30%. The heat reflective paint's colours should be limited to a Total Solar Reflectance (TSR) value greater than 29%.

Any paint or stain must be recommended by the manufacturer as being suitable for the proposed application and must be applied in a manner in strict compliance to the manufacturer's recommendations.

2. LOSP Treated

Wait until excess solvents have evaporated and timber is dry. The pressure of the solvent (white spirits) from the LOSP treatment may affect the drying and hardening of paints if there has been insufficient evaporation time after the treatment. It is strongly recommended that the treated timber is left to recondition for at least 7 days in the end use situation before painting.

One coat of premium quality primer as a minimum should be applied to all surfaces prior to erection of beam and to any cuts or holes drilled. If the first coat of primer, sealant paint or stain fails to dry or adhere within the time expected, do not proceed to any further coats until the first coat has achieved satisfactory dryness and adhesion. If the first coat fails to dry it may be necessary to strip back to bare timber and allow it to weather for another week or two.

a. Paint

Exterior solid colour acrylic finish. One coat of oil based primer followed by one or two coats of the exterior acrylic finish as required.

or

Exterior solid colour oil based enamel. One coat of oil based primer followed by one coat of oil based under-coat (if required) then two coats of the oil based enamel.

b. Stains

Exterior semi-transparent or solid colour penetrating oil based stain or similar. Two or three coats of the stain as required or recommended by the manufacturer.

Water based stains and un-pigmented sealants, oil or water repellents are NOT recommended.

3. Tru-Core® Treated

1. The wood must be dry and clean prior to applying any finish coating. If initial cleaning of the treated wood is needed, it is recommended that the project be cleaned with a deck cleaning product and allow to fully dry.
2. At this time, a clear water repellent may be added to the project. If applied, allow 8 weeks prior to the application of a semi-transparent stain or paint.
3. If no water repellent is added, an oil based stain can be

applied to the clean, dry wood in 30-60 days from treatment date.

4. A water based stain can be applied to the clean, dry wood in 45-70 days from treatment date.
5. Depending on the treatment method used, if the wood is left uncoated and without UV protection:
 - i. The typical brown colour of the Copper Quat treated wood will naturally weather to a grey colour over long-term exposure to the sun.
 - ii. The Azole treated wood has no colouration so it will naturally weather to a grey colour over long-term exposure to the sun.

Users must always conduct their own tests on coatings in inconspicuous areas of the project to determine acceptability of colour, adhesion and appearance.

1.12.8 H3 Deck bearers and joists

H3 Treated Deck joists and bearers are a common application for treated SmartLVL. The diagram demonstrates the minimum construction detailing for H3 treated joists and bearers. Failure to follow these guidelines may render treatment warranties void.

It is recommended that deck nails be slightly skewed as per the detail below.

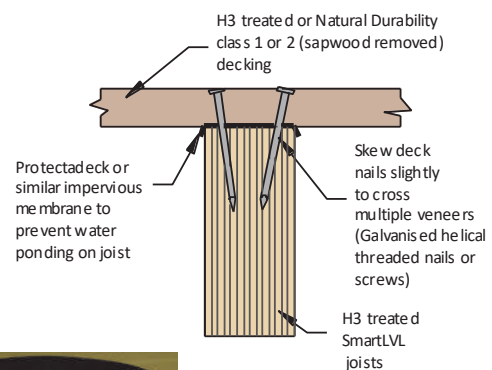
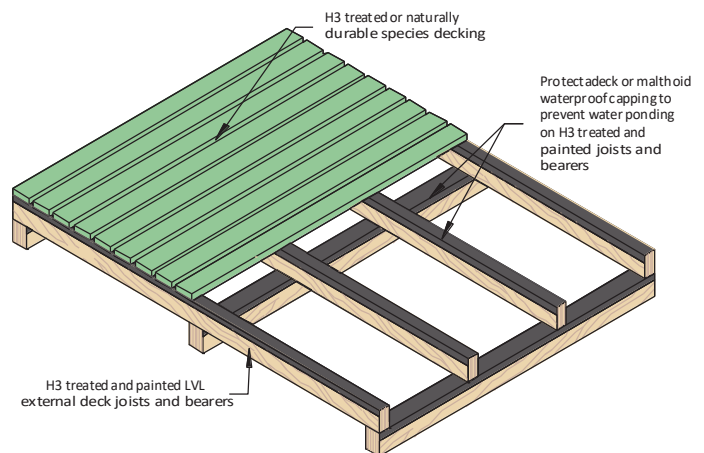

Recommended proprietary top protection for joists and bearers

1.13 SmartLVL hanger details

Given the high load carrying capacity of SmartLVL, it is essential that the connection of SmartLVL to other structural members is considered carefully, with the industry practice of simple skew or end nailing of SmartLVL not recommended for anything but the lightest loads.

The list below contains the common light to medium duty

SmartLVL framing brackets stocked by Tilling Timber. Member connections requiring capacities greater than those listed below can be designed by your own Engineer or SmartFrame Engineers, but any non-standard connection system designed by your own engineer or SmartFrame Engineers may take some time to have fabricated.

Framing bracket code	Fixing to SUPPORTING beam	Design Capacity ϕN_j (kN) $1.2G+1.5Q_f$ (DL + FLL) JD4	Fixing to SUPPORTED beam	Wind Uplift ($k_f = 1.14$)			
				Design Capacity ϕN_j (kN) $1.2G+1.5Q_f$ (DL + RLL) for Joint group			
				JD5	JD4	JD3	Max.
FB3590, FB4290	8 Nails	4.6	4 nails	3.2	3.7	5.3	6.0
	4 Screws	6.1	2 screws	3.5	5.0	5.0	5.0
FB35120, FB42120	12 Nails	6.4	6 nails	4.7	5.7	7.9	9.0
	6 Screws	9.1	4 screws	7.1	10.0	10.0	10.0
FB35140, FB42140	16 Nails	8.4	8 nails	6.2	7.5	10.6	12.0
	6 Screws	9.1	4 screws	7.1	10.0	10.0	10.0
FB35180, FB42180	20 Nails	10.3	10 nails	7.4	8.9	12.4	15.0*
	8 Screws	12.1	6 Screws	10.6	15.0*	15.0*	15.0*
FB42220	26 Nails	13.1	13 nails	9.5	11.3	15.0*	15.0*
	10 Screws	14.2	8 Screws	14.2	15.0*	15.0*	15.0*
FB60130	12 Nails	6.4	3 nails	2.4	2.8	3.9	4.5
	4 screws	6.1	7 nails	5.4	6.6	9.3	10.5
FB65170	18 Nails	9.3	4 screws	7.1	10.0	10.0	10.0
	6 screws	9.1	6 nails	4.7	5.7	7.9	9.0
FB90200	11 nails	8.1	11 nails	8.1	9.8	13.6	15.0*
	6 screws	10.6	6 screws	10.6	15.0*	15.0*	15.0*
FB90200	26 Nails	12.9	3 nails	2.4	2.8	3.9	4.5
	10 Screws	14.2	13 nails	9.6	11.6	15.0*	15.0*
FB90200	8 screws	14.2	8 screws	14.2	15.0*	15.0*	15.0*
	LVSIA (Horizontal)	6 screws	8.2	1 screw	1.0	1.4	1.8
LVSIA (Vertical)	6 screws	5.8	6 screws	8.6	13.3	13.3	13.3
Pryda JHS (pair)	16 Nails	15.0	16 Nails	23.8	28.3	29.8	29.8
	16/8g x 25 mm type 17 screws	17.9	16 Screws	33.7	40.0	40.0	40
MiTek SPH180 (pair)	4 MSA1430 screws [‡]	11.4	4 MSA1430 screws	13.3	18.8	20.4	20.4
	8 MSA1430 screws [‡]	20.9	8 MSA1430 screws	24.5	34.6	37.8	37.8
MiTek SPH220 (pair)	5 MSA1430 screws [‡]	13.4	5 MSA1430 screws	15.7	22.1	25.5	25.5
	10 MSA1430 screws [‡]	25.6	10 MSA1430 screws	30.0	42.3	46.0	46.0
Dunnings Girder brackets	4 nails [‡]	6.2	4 nails [‡]	8.4	10.2	14.4	14.4
	6 nails [‡]	9.4	6 nails [‡]	12.6	15.4	21.6	21.6

[‡] in each face of joist hanger

Notes:

- For this table, SmartLVL has been given a uniform JD4 Joint Strength Group. For more detailed calculations of joint strength group in particular planes contact the Techsupport Helpline on 1300 668 690
- The above tabulated capacities are for a minimum beam thickness of 35 mm.
- For all Pryda FB, LVSIA and JHS brackets - Nails :Pryda 35 x 3.15 galvanised Pryda Timber Connection nails or equivalent, Screws: No 12 Type 17 x 35 mm
- MSA1430 are MiTek No 14 Type 17 x 30 mm screws
- Wind uplift capacities apply to designs in accordance with AS/NZS 1170:2002
- Pryda FB Framing Bracket capacity has been limited to 15.0 kN shown *
- These capacities apply directly for joints in houses and on secondary beams in other structures. For joints on primary beams in structures other than houses, reduce the capacity by $0.85/0.95 = 0.89$
- For FB65170 brackets, wind uplift dead load values have been reduced due to a shorter end distance on the supported beam compared to the other brackets.
- Multiple Laminated Supporting Beams - Fasteners with longer lengths are required when Joist Hangers are fixed into a multiple laminated supporting beam. For double laminates, use 65 long nails or screws. Alternatively, for double or triple laminated supporting beams, additional fixings may be provided at hanger locations to laminate plies. Seek advice from the Engineer.

2. Index of Span Tables

Floor Joists supporting floor Loads only - 40 kg/m ²	12
Bearers supporting floor Joists only - 40 kg/m ²	
- Single span	13
- Continuous span	14
Bearers supporting single storey load bearing wall	
- Single span	15
- Continuous span	17
Bearers supporting double storey load bearing wall	
- Single span	19
- Continuous span	20
Lintels in single or upper storey walls	
- wind classification N1-N3	23
- wind classification C1-C3	25
Lintels in lower storey walls	26
Roof beam/Rafters with ceiling	
- wind classification N1-N3	29
- wind classification C1-C3	31
Roof beam/Rafters without ceiling	
- wind classification N1-N3	35
- wind classification C1-C3	38
Roof Beams - Ridge or Intermediate Beams—wind classification N1-N3	
- Single span	41
- Continuous span	43
Roof Beams - Ridge or Intermediate Beams—wind classification C1-C3	
- Single span	45
- Continuous span	47
Verandah Beams - wind classification N1-N3	
- Single span	49
- Continuous span	50
Verandah Beams - wind classification C1-C3	
- Single span	55
- Continuous span	58
Hip Rafters	61
Underpurlins	
- wind classification N1-N3	62
- wind classification C1-C3	63
Hanging Beams	
- wind classification N1-N3	64
- wind classification C1-C3	66
Counter Beam (supporting Hanging Beams)	
- wind classification N1-N3	66
- wind classification C1-C3	67
Strutting Beam (supporting Underpurlins) -- Sheet roof	
- wind classification N1-N3	68
- wind classification C1-C3	70
Strutting Counter Beam (supporting Underpurlins & Hanging Beams)	
- wind classification N1-N3	72
- wind classification C1-C3	73
Strutting Hanging Beam (supporting Underpurlins and ceiling)	
- wind classification N1-N3	76
- wind classification C1-C3	78
Ceiling Joists	80

WA Supplement

SmartSplay® Roof Void Beams	81
SmartSplay 15 Strutting Beam supporting Underpurlins	82
SmartSplay 15 Strutting / Hanging Beam supporting Underpurlins	83
SmartSplay 15 Counter Beams supporting Hanging Beams	84
SmartSplay 15 Strutting / Counter Beams supporting Underpurlins & Hanging Beams	85
Pryda WA Beam hanger	86
SmartLVL 11 Underpurlins	87
SmartLVL 11 Roof struts	87

Floor joists supporting floor loads only

Floor mass - 40 kg/m²

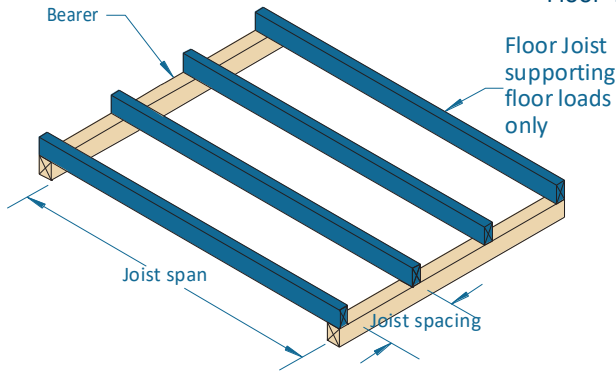

EXAMPLE:

domestic floor loads
single span
joist spacing = 450 mm
joist span = 3500 mm

Enter single span table at 450 mm in joist spacing column, read down to a span equal to or greater than 3500 mm

ADOPT:

SmartLVL 14 - 190x35

Loadings: permanent - self weight + 40 kg/m² + 0.5 kPa of the live load, live load - 1.5 kPa or floor point load of 1.8 kN

Joist spacing (mm)	300	450	600	300	450	600
Member size DxB (mm)	Maximum recommended span (mm)					
	Single span			Continuous span		
90x35	1800	1600	1500	2250	1900	1750
120x35	2900	2250	2100	3550	2650	2400
130x35	3150	2450	2250	3900	2950	2650
140x35	3400	2650	2450	4200	3200	2850
150x35	3600	2900	2650	4450	3450	3100
170x35	4100	3350	3050	4850	4050	3550
190x35	4550	3800	3450	5300	4650	4000
200x35	4700	4050	3650	5500	4950	4250
240x35	5350	4900	4450	6300	5700	5200
300x35	6300	5750	5400	7450	6750	6250
90x42	2100	1800	1700	2600	2100	1900
120x42	3400	2500	2300	3900	3000	2700
130x42	3600	2700	2500	4200	3300	2900
140x42	3900	3000	2700	4500	3600	3200
150x42	4100	3200	2900	4700	3900	3400
170x42	4500	3700	3300	5200	4500	3900
190x42	4900	4200	3800	5700	5100	4400
200x42	5100	4500	4000	5900	5300	4700
240x42	5800	5200	4900	6700	6100	5700
300x42	6900	6200	5800	8000	7200	6700
360x42	7900	7100	6600	9100	8300	7700
400x42	8500	7700	7100	8300	9000	8300
90x58	2500	2000	1900	3200	2400	2200
130x58	4000	3100	2800	4600	3700	3300
150x58	4400	3600	3300	5100	4500	3800
170x58	4800	4200	3800	5600	5100	4400
200x58	5500	4900	4500	6400	5800	5300
240x58	6300	5700	5300	7300	6600	6100
300x58	7400	6700	6200	8600	7800	7200
360x58	8400	7700	7200	10400	8900	8300
400x58	9000	8400	7800	11300	9700	9000
450x58	9700	9100	8500	12000	9900	9800
240x75	6700	6100	5600	7800	7000	6500
300x75	7700	7200	6700	9200	8300	7700
400x75	9400	8800	8300	12000	9900	9600
525x75	10500	9900	10000	12000	10000	9900
300x82	7800	7300	6800	9400	8500	7900
400x82	9500	8900	8500	12000	9900	9800

NOTES:

- Sizes and spans shown in italics are SmartLVL 14, all others are SmartLVL 15
- Spans are suitable for solid timber, particle board and ply flooring. floor sheeting glued and nailed to joists will improve floor rigidity. Where heavy overlay material is to be applied, such as a mortar bed tiled or slate floor, the permanent load allowance should be increased to 1.2 kPa. A reduction of joist spacing may be used to accommodate this extra permanent load. A satisfactory result can be achieved by adopting the maximum spans for 600 mm and 450 mm spacing but installing the joists at 450 and 300 mm spacing respectively
- For beams which are continuous over two unequal spans, the design span and the 'resultant span description' depend upon the percentage span differences between the two spans as shown on page 2
- D = member depth, B = member breadth, NS = not suitable.
- End bearing lengths = 42 mm at end supports and 58 mm at internal supports for continuous members
- Not all sizes of SmartLVL in this table are stocked in each state. Please check with your supplier before ordering WA only

Single span floor bearers supporting floor loads only

Floor mass - 40 kg/m²

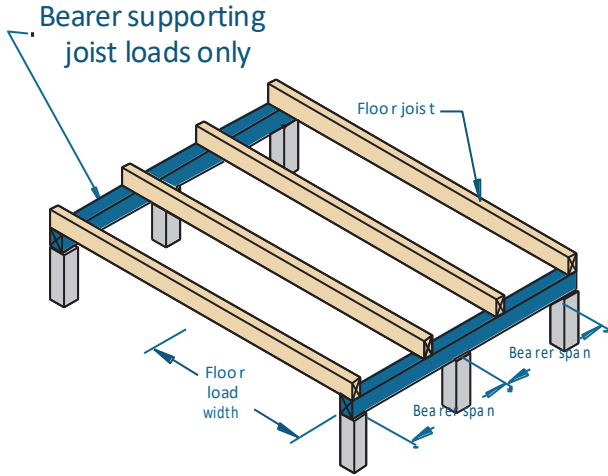

EXAMPLE:

single span bearer = 4000 mm
 floor load width = 6000 mm

Enter single span table at 6000 mm in floor load width column, read down to a span equal to or greater than 4000 mm

ADOPT:

SmartLVL 15 - 2/360 x 42

(Additional bearing length of 20 mm required)

Loadings: permanent - self weight + 40 kg/m² + 0.5 kPa of the live load, live load - 1.5 kPa or floor point load of 1.8 kN

Floor load width (mm)	1200	1800	2400	3000	3600	4200	4800	5400	6000	6600
Member size DxB (mm)	Maximum recommended bearer span (mm)									
	Single span									
2/90x35	1750	1500	1350	1250	1200	1100	1050	1000	NS	NS
2/120x35	2300	2000	1850	1700	1600	1500	1400	1350	1300	1250
2/130x35	2500	2200	2000	1850	1700	1600	1550	1500	1400	1350
2/140x35	2700	2350	2150	1950	1850	1750	1650	1600	1550	1500
2/150x35	2900	2500	2300	2100	2000	1900	1800	1700	1650	1600
2/170x35	3250	2850	2600	2400	2250	2150	2050	1950	1850	1800
2/190x35	3650	3200	2900	2700	2500	2400	2250	2150	2100	2000
2/200x35	3750	3350	3050	2800	2650	2500	2400	2300	2200	2100
2/240x35	4300	3900	3650	3400	3150	3000	2850	2750	2650	2550
2/300x35	5100	4600	4300	4050	3850	3700	3600	3450 ₅	3300 ₅	3200 ₁₀
2/90x42	2050	1800	1600	1500	1400	1300	1250	1200	1150	1100
2/120x42	2700	2400	2150	2000	1850	1750	1700	1600	1550	1500
2/130x42	2950	2550	2350	2150	2000	1900	1800	1750	1650	1600
2/140x42	3150	2750	2500	2300	2200	2050	1950	1850	1800	1750
2/150x42	3400	2950	2700	2500	2350	2200	2100	2000	1950	1850
2/170x42	3750	3350	3050	2800	2650	2500	2400	2300	2200	2100
2/190x42	4100	3700	3400	3150	2950	2800	2650	2550	2450	2350
2/200x42	4250	3850	3550	3300	3100	2950	2800	2700	2600	2500
2/240x42	4850	4400	4100	3850	3700	3500	3350	3200	3100	3000
2/300x42	5700	5150	4800	4550	4350	4200	4050	3900 ₅	3800 ₁₀	3700 ₁₀
2/360x42	6500	5900	5500	5200	5000	4800	4600 ₅	4450 ₁₀	4350 ₁₅	4250 ₂₀
2/400x42	7000	6400	5950	5650	5400	5150 ₅	5000 ₁₀	4850 ₁₅	4700 ₂₀	4550 ₂₅
90x58	1800	1600	1400	1300	1250	1150	1100	1050	1000	NS
130x58	2600	2300	2050	1900	1800	1700	1600	1550	1450	1400
150x58	3000	2650	2400	2200	2050	1950	1850	1750	1700	1650
170x58	3400	3000	2700	2500	2350	2200	2100	2000	1950	1850
190x58	3750	3300	3000	2800	2600	2450	2350	2250	2150	2100
200x58	3900	3500	3150	2950	2750	2600	2500	2350	2300	2200 ₅
240x58	4450	4000	3750	3500	3300	3100	2950 ₅	2850 ₅	2750 ₁₀	2650 ₁₅
300x58	5250	4750	4400	4150	4000 ₅	3800 ₁₀	3700 ₁₅	3550 ₂₀	3400 ₂₀	3300 ₂₅
360x58	6000	5450	5050	4800 ₅	4550 ₁₀	4350 ₁₅	4200 ₂₀	4100 ₂₅	3950 ₃₀	3850 ₃₅
400x58	6450	5850	5450	5150 ₅	4900 ₁₅	4750 ₂₀	4550 ₂₅	4400 ₃₀	4300 ₄₀	4200 ₄₅
450x58	7000	6400	5950 ₅	5650 ₁₀	5350 ₂₀	5150 ₂₅	5000 ₃₀	4800 ₄₀	4700 ₄₅	4550 ₅₀
240x75	4700	4300	4000	3750	3600	3400	3250	3100	3000	2850 ₅
300x75	5550	5050	4700	4450	4250	4050	3900 ₅	3800 ₁₀	3700 ₁₀	3600 ₁₅
400x75	6800	6200	5800	5500	5250 ₅	5050 ₁₀	4850 ₁₅	4700 ₂₀	4550 ₂₅	4450 ₃₀
525x75	8250	7550	7050	6700 ₅	6400 ₁₅	6150 ₂₀	5950 ₂₅	5750 ₃₅	5600 ₄₀	5450 ₄₅
300x82	5650	5150	4800	4550	4300	4150	4000	3900 ₅	3750 ₁₀	3650 ₁₀
400x82	6950	6350	5900	5600	5350	5150 ₅	4950 ₁₀	4800 ₁₅	4650 ₂₀	4550 ₂₅

Continuous span floor bearers supporting floor loads only

Floor mass - 40 kg/m²

Loadings: permanent - self weight + 40 kg/m² + 0.5 kPa of the live load, live load - 1.5 kPa or floor point load of 1.8 kN

Floor load width (mm)	1200	1800	2400	3000	3600	4200	4800	5400	6000	6600
Member size DxB (mm)	Maximum recommended bearer span (mm)									
	Continuous span									
<i>2/90x35</i>	2350	2050	1850	1700	1600	1500	1450	1400	1350	1300
<i>2/120x35</i>	3100	2750	2500	2300	2150	2050	1950	1850	1750	1700
<i>2/130x35</i>	3350	2950	2700	2500	2350	2200	2100	2000	1900	1800
<i>2/140x35</i>	3550	3200	2900	2700	2500	2400	2250	2150	2050	1950 ₅
<i>2/150x35</i>	3700	3350	3100	2900	2700	2550	2450	2300	2150 ₅	2050 ₁₀
<i>2/170x35</i>	4100	3700	3450	3250	3050	2900	2750 ₅	2550 ₁₀	2450 ₁₅	2300 ₂₀
<i>2/190x35</i>	4450	4000	3750	3550	3400	3250 ₅	3000 ₁₅	2850 ₂₀	2700 ₂₅	2550 ₃₀
<i>2/200x35</i>	4600	4200	3900	3700	3500	3400 ₁₀	3150 ₂₀	2950 ₂₅	2800 ₃₀	2650 ₃₅
<i>2/240x35</i>	5300	4800	4450	4200	4050 ₁₅	3850 ₂₅	3700 ₃₅	3500 ₄₀	3300 ₅₀	3150 ₅₅
<i>2/300x35</i>	6250	5650	5250	5000 ₁₅	4750 ₃₀	4600 ₄₅	4450 ₅₅	4250 ₇₀	4050 ₈₀	3850 ₉₀
<i>2/90x42</i>	2550	2250	2050	1900	1750	1650	1600	1500	1450	1400
<i>2/120x42</i>	3350	3000	2700	2500	2350	2250	2100	2050	1950	1900
<i>2/130x42</i>	3600	3250	2950	2700	2550	2400	2300	2200	2100	2050 ₅
<i>2/140x42</i>	3800	3400	3150	2950	2750	2600	2500	2350	2300 ₅	2200 ₁₀
<i>2/150x42</i>	4000	3600	3350	3150	2950	2800	2650	2550 ₅	2450 ₁₀	2350 ₁₅
<i>2/170x42</i>	4400	3950	3700	3500	3350	3150	3000 ₅	2900 ₁₅	2750 ₂₀	2700 ₂₅
<i>2/190x42</i>	4750	4300	4000	3800	3600	3500 ₁₀	3350 ₁₅	3200 ₂₀	3100 ₃₀	3000 ₃₅
<i>2/200x42</i>	4950	4450	4150	3950	3750	3600 ₁₀	3500 ₂₀	3400 ₂₅	3250 ₃₅	3150 ₄₀
<i>2/240x42</i>	5650	5100	4750	4500	4300 ₁₀	4150 ₂₀	4000 ₃₀	3900 ₄₀	3800 ₅₀	3700 ₆₀
<i>2/300x42</i>	6700	6050	5650 ₅	5350 ₁₅	5100 ₂₅	4900 ₄₀	4750 ₅₀	4600 ₆₀	4500 ₇₅	4400 ₉₅
<i>2/360x42</i>	7700	6950	6450 ₁₅	6100 ₂₅	5850 ₄₀	5600 ₅₅	5450 ₆₅	5300 ₉₀	5150 ₁₀₅	5000 ₁₂₀
<i>2/400x42</i>	8300	7500 ₅	7000 ₂₀	6600 ₃₅	6300 ₅₀	6100 ₆₅	5900 ₈₅	5700 ₁₀₅	5550 ₁₂₀	5450 ₁₃₅
90x58	2250	1950	1800	1650	1550	1450	1350	1300	1200	1150
130x58	3250	2850	2600	2400	2200	2050	1900	1800 ₅	1700 ₁₀	1600 ₁₅
150x58	3650	3300	3000	2750	2500	2300 ₅	2150 ₁₀	2050 ₁₅	1900 ₂₀	1850 ₂₅
170x58	4000	3600	3350	3100	2800 ₅	2600 ₁₅	2400 ₂₀	2250 ₂₅	2150 ₃₀	2050 ₃₅
200x58	4500	4050	3800	3550 ₁₀	3250 ₂₀	3000 ₂₅	2800 ₃₀	2650 ₄₀	2500 ₄₅	2350 ₅₀
240x58	5150	4650	4350 ₁₀	4100 ₂₅	3850 ₃₅	3550 ₄₀	3300 ₅₀	3100 ₅₅	2950 ₆₅	2800 ₇₀
300x58	6100	5500 ₅	5150 ₂₅	4850 ₄₀	4650 ₅₅	4300 ₆₅	4050 ₈₀	3800 ₉₅	3600 ₁₀₅	3400 ₁₁₅
360x58	7000	6350 ₁₅	5900 ₃₅	5550 ₅₅	5300 ₇₅	5100 ₁₀₅	4750 ₁₁₅	4450 ₁₂₅	4200 ₁₃₅	4000 ₁₄₅
400x58	7600	6850 ₂₅	6400 ₄₅	6050 ₆₅	5750 ₉₅	5550 ₁₁₅	5200 ₁₃₀	4900 ₁₄₀	4650 ₁₅₅	4400 ₁₆₅
450x58	8300 ₁₀	7500 ₃₀	6950 ₅₅	6600 ₈₅	6300 ₁₁₀	6050 ₁₃₅	5800 ₁₅₀	5450 ₁₆₅	5150 ₁₇₅	4900 ₁₉₀
240x75	5500	5000	4650	4400 ₁₀	4150 ₂₀	3850 ₂₅	3600 ₃₀	3400 ₄₀	3200 ₄₅	3050 ₅₀
300x75	6500	5900	5500 ₁₀	5200 ₂₀	4950 ₃₅	4700 ₄₅	4400 ₅₅	4100 ₆₀	3900 ₇₀	3700 ₈₀
400x75	8100	7300 ₁₀	6800 ₂₅	6450 ₄₅	6150 ₆₀	5900 ₈₀	5650 ₁₀₀	5350 ₁₁₀	5050 ₁₂₀	4800 ₁₃₀
525x75	9900 ₅	8950 ₂₅	8350 ₅₀	7900 ₇₀	7550 ₁₀₀	7250 ₁₂₀	7000 ₁₄₀	6800 ₁₆₀	6450 ₁₇₀	6150 ₁₈₅
300x82	6650	6000	5600 ₅	5300 ₁₅	5050 ₃₀	4850 ₄₀	4500 ₄₅	4250 ₅₅	4000 ₆₀	3800 ₆₅
400x82	8250	7450 ₅	6950 ₂₀	6600 ₃₅	6300 ₅₀	6050 ₆₅	5850 ₉₀	5500 ₁₀₀	5200 ₁₁₀	4950 ₁₂₀

NOTES:

- Sizes in italics are SmartLVL 14
- D = member depth, B = member breadth, NS = not suitable.
- The above table was based on a maximum DL of 40 (kg/m²) + 0.5 kPa of LL, floor live load of 1.5 (kPa), floor point load of 1.8 (kN)
- End bearing lengths = 42 mm at end supports and 58 mm at internal supports for continuous members. Subscript values indicate the minimum additional bearing length where required to be greater than 42 mm at end supports and 58 mm at internal supports
- Restraint value for slenderness calculations is 600 mm (floor joist centres at 600 mm max)
- Not all sizes of SmartLVL in this table are stocked in each state. Please check with your supplier before ordering WA only

Floor bearers supporting single storey load bearing wall - sheet and tiled roof

Floor mass - 40 kg/m²

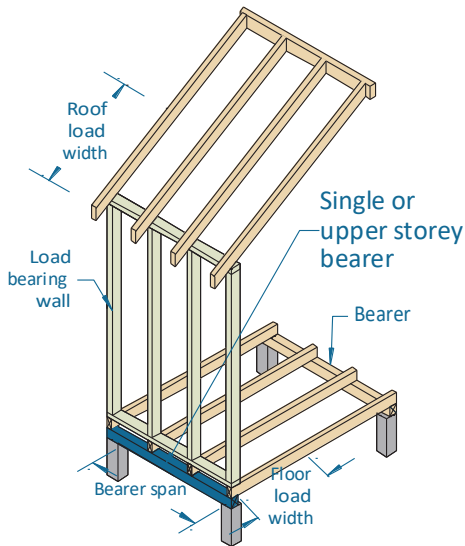

EXAMPLE:

sheet roof - 40 kg/m²
 roof load width = 1950 mm
 bearer span = 3000 mm (single span)
 floor load width = 2200 mm

Enter single span table at 2400 mm in floor load width column, 4500 roof load width column, read down to a span equal to or greater than 3000 mm in the 40 kg/m² row.

ADOPT:

SmartLVL 14—2/300x35

Single span

Floor load width (mm)		1200			2400			4800		
Roof load width (mm)		1500	4500	7500	1500	4500	7500	1500	4500	7500
Member size DxB (mm)	Roof mass (kg/m ²)	Maximum recommended single span floor bearer supporting single storey load bearing wall span (mm)								
2/90x35	40	1350	1200	1100	1200	1100	1000	NS	NS	NS
	90	1250	1050	NS	1100	NS	NS	NS	NS	NS
2/120x35	40	1800	1600	1500	1600	1450	1350	1300	1250	1200
	90	1700	1400	1250	1500	1300	1200	1300	1150	1100
2/130x35	40	1950	1750	1600	1700	1600	1500	1450	1350	1300
	90	1800	1500	1350	1650	1400	1300	1400	1250	1150
2/140x35	40	2100	1900	1750	1850	1700	1600	1550	1450	1400
	90	1950	1650	1450	1750	1550	1400	1500	1350	1250
2/150x35	40	2250	2050	1850	2000	1850	1700	1650	1600	1500
	90	2100	1750	1550	1900	1650	1500	1600	1450	1350
2/170x35	40	2550	2300	2100	2250	2100	1950	1900	1800	1700
	90	2400	2000	1800	2150	1850	1700	1800	1650	1550
2/190x35	40	2850	2550	2350	2500	2300	2200	2100	2000	1900
	90	2650	2250	2000	2400	2100	1900	2050	1850	1750
2/200x35	40	3000	2700	2500	2650	2450	2300	2200	2100	2000
	90	2800	2350	2100	2500	2200	2000	2150	1950	1800
2/240x35	40	3600	3250	3000	3150	2950	2750	2650	2550	2450
	90	3350	2800	2500	3000	2650	2400	2600	2350	2200
2/300x35	40	4250	3950	3700	3850	3650	3450	3300	3150 ₅	3050 ₅
	90	4050	3500	3150	3700	3300	3000	3200	2950 ₅	2750 ₁₀
90x42	40	1200	1050	NS	1050	NS	NS	NS	NS	NS
	90	1100	NS	NS	NS	NS	NS	NS	NS	NS
120x42	40	1600	1400	1300	1400	1250	1200	1150	1100	1050
	90	1450	1200	1100	1300	1150	1050	1100	1000	NS
130x42	40	1700	1550	1400	1500	1400	1300	1250	1200	1150
	90	1600	1300	1200	1400	1250	1100	1200	1100	1000
140x42	40	1850	1650	1500	1600	1500	1400	1350	1300	1250
	90	1700	1450	1250	1550	1350	1200	1300	1200	1100
150x42	40	2000	1750	1650	1750	1600	1500	1450	1350	1300
	90	1850	1550	1350	1650	1450	1300	1400	1250	1200
170x42	40	2250	2000	1850	1950	1800	1700	1650	1550	1500
	90	2100	1750	1550	1850	1600	1450	1600	1450	1350 ₅
190x42	40	2500	2250	2050	2200	2050	1900	1850	1750	1650
	90	2350	1950	1750	2100	1800	1650	1800	1600 ₅	1500 ₁₀
200x42	40	2650	2350	2150	2300	2150	2000	1950	1850	1750 ₅
	90	2450	2050	1800	2200	1900	1750 ₅	1850	1700 ₅	1600 ₁₀
240x42	40	3150	2850	2600	2750	2550	2400	2300 ₁₀	2200 ₁₀	2100 ₁₀
	90	2950	2450	2200 ₁₀	2650	2300 ₅	2100 ₁₅	2250 ₁₀	2050 ₁₅	1900 ₂₀
300x42	40	3850	3550	3250 ₅	3450	3200 ₅	3000 ₁₀	2900 ₂₀	2750 ₂₀	2650 ₂₅
	90	3650	3100 ₁₀	2750 ₂₀	3300	2850 ₁₅	2600 ₂₅	2800 ₂₀	2550 ₂₅	2400 ₄₀

Floor bearers supporting single storey load bearing wall - sheet and tiled roof

Single span (Cont'd)

Floor load width (mm)		1200			2400			4800		
Roof load width (mm)		1500	4500	7500	1500	4500	7500	1500	4500	7500
Member size DxB (mm)	Roof mass (kg/m ²)	Maximum recommended single span floor bearer supporting single storey load bearing wall span (mm)								
2/90x42	40	1500	1350	1200	1300	1200	1150	1100	1050	1000
	90	1400	1150	1000	1250	1050	NS	1050	NS	NS
2/120x42	40	2000	1800	1650	1750	1600	1500	1450	1400	1350
	90	1850	1550	1350	1650	1450	1300	1400	1300	1200
2/130x42	40	2150	1950	1750	1900	1750	1650	1550	1500	1450
	90	2000	1650	1500	1800	1550	1400	1550	1400	1300
2/140x42	40	2300	2100	1900	2050	1900	1750	1700	1600	1550
	90	2150	1800	1600	1950	1700	1500	1650	1500	1400
2/150x42	40	2500	2250	2050	2200	2000	1900	1800	1750	1650
	90	2300	1950	1700	2050	1800	1650	1750	1600	1500
2/170x42	40	2800	2500	2350	2450	2300	2150	2050	1950	1900
	90	2600	2200	1950	2350	2050	1850	2000	1850	1700
2/190x42	40	3150	2800	2600	2750	2550	2400	2300	2200	2100
	90	2900	2450	2200	2600	2300	2100	2250	2050	1900
2/200x42	40	3300	2950	2750	2900	2700	2500	2450	2300	2200
	90	3100	2600	2300	2750	2400	2200	2350	2150	2000
2/240x42	40	3850	3550	3300	3500	3200	3050	2900	2800	2650
	90	3650	3100	2750	3300	2900	2650	2850	2600	2400
2/300x42	40	4550	4200	3950	4150	3900	3750	3650	3450	3350
	90	4300	3800	3450	4000	3600	3300	3550	3250 ₅	3000 ₁₀
2/360x42	40	5200	4800	4550	4750	4450	4250	4150 ₅	4000 ₅	3900 ₁₀
	90	4950	4350	4000 ₅	4550	4150	3850 ₁₀	4050 ₅	3800 ₁₀	3600 ₂₀
2/400x42	40	5600	5200	4900	5150	4850	4600	4500 ₅	4350 ₁₀	4200 ₁₀
	90	5350	4700	4300 ₁₀	4950	4450 ₅	4150 ₁₅	4400 ₁₀	4100 ₁₅	3900 ₂₅
90x58	40	1300	1150	1100	1150	1050	1000	NS	NS	NS
	90	1200	1000	NS	1100	NS	NS	NS	NS	NS
130x58	40	1900	1700	1550	1650	1550	1450	1400	1300	1250
	90	1750	1500	1300	1600	1400	1250	1350	1250	1150
150x58	40	2200	1950	1800	1900	1800	1650	1600	1550	1450
	90	2050	1700	1500	1850	1600	1450	1550	1400	1300
170x58	40	2500	2250	2050	2200	2000	1900	1800	1750	1650
	90	2300	1950	1700	2050	1800	1650	1750	1600	1500
200x58	40	2950	2650	2400	2550	2400	2250	2150	2050	1950
	90	2750	2300	2050	2450	2150	1950	2100	1900	1750
240x58	40	3500	3150	2900	3100	2850	2700	2600	2450	2350
	90	3250	2750	2450	2950	2550	2300 ₅	2500	2300 ₅	2150 ₁₀
300x58	40	4200	3850	3600	3800	3550	3350	3200 ₁₀	3100 ₁₀	2950 ₁₀
	90	3950	3400	3050 ₁₀	3650	3200 ₅	2900 ₁₅	3150 ₁₀	2850 ₁₅	2650 ₂₅
360x58	40	4800	4400	4150	4350	4100	3900 ₅	3800 ₁₅	3650 ₂₀	3550 ₂₅
	90	4500	3950 ₅	3650 ₂₀	4150	3750 ₁₀	3500 ₂₅	3700 ₂₀	3400 ₂₅	3200 ₃₅
400x58	40	5150	4750	4500 ₅	4700	4400 ₅	4200 ₁₀	4100 ₂₀	3950 ₂₅	3850 ₃₀
	90	4900	4300 ₁₀	3950 ₂₅	4500	4100 ₁₅	3800 ₃₀	4000 ₂₅	3750 ₃₀	3550 ₄₅
450x58	40	5650	5200	4900 ₅	5100 ₅	4800 ₁₀	4600 ₁₅	4500 ₃₀	4300 ₃₀	4200 ₃₅
	90	5350	4700 ₁₅	4300 ₃₀	4900 ₅	4450 ₂₀	4150 ₃₅	4400 ₃₀	4100 ₄₀	3900 ₅₀
240x75	40	3650	3300	3050	3250	3000	2800	2700	2600	2500
	90	3450	2900	2550	3100	2700	2450	2650	2400	2250
300x75	40	4350	4000	3750	3950	3700	3500	3400	3250	3100 ₅
	90	4100	3600	3200	3800	3350	3050	3300	3000 ₅	2800 ₁₀
400x75	40	5350	4950	4650	4850	4600	4400	4250 ₁₀	4100 ₁₀	4000 ₁₅
	90	5100	4450	4100 ₅	4700	4250	3950 ₁₀	4150 ₁₀	3900 ₁₅	3700 ₂₅
525x75	40	6550	6050	5700	5950	5600 ₅	5350 ₅	5200 ₂₀	5050 ₂₅	4900 ₃₀
	90	6200	5450 ₅	5000 ₁₅	5750	5200 ₁₀	4850 ₂₅	5100 ₂₅	4750 ₃₀	4550 ₃₅
300x82	40	4500	4150	3900	4100	3850	3700	3600	3400 ₅	3300 ₅
	90	4250	3750	3400	3950	3550	3200 ₅	3500 ₅	3150 ₅	2950 ₁₀
400x82	40	5550	5150	4850	5050	4800	4550	4450 ₁₀	4300 ₁₅	4150 ₂₀
	90	5300	4650	4250 ₁₀	4900	4400 ₅	4000 ₁₅	4350 ₁₅	4050 ₂₀	3850 ₂₅

Floor bearers supporting single storey load bearing wall - sheet and tiled roof

Continuous span

Floor load width (mm)		1200			2400			4800		
Roof load width (mm)		1500	4500	7500	1500	4500	7500	1500	4500	7500
Member size DxB (mm)	Roof mass (kg/m ²)	Maximum recommended Continuous span floor bearer supporting single storey load bearing wall span (mm)								
2/90x35	40	1850	1650	1500	1650	1500	1400	1350	1300	1250
	90	1700	1450	1250	1550	1350	1200	1300	1200	1100
2/120x35	40	2500	2200	2050	2200	2000	1900	1800	1750	1650
	90	2300	1900	1700	2050	1800	1600	1750	1600	1500
2/130x35	40	2700	2400	2200	2350	2200	2050	1950	1900	1800
	90	2500	2100	1850	2250	1950	1750	1900	1750	1600
2/140x35	40	2900	2600	2400	2550	2350	2200	2150	2000	1950
	90	2700	2250	2000	2400	2100	1900	2050	1850	1750 ₅
2/150x35	40	3100	2750	2550	2700	2500	2350	2300	2150	2100
	90	2900	2400	2150	2600	2250	2050	2200	2000	1850 ₁₀
2/170x35	40	3500	3150	2900	3100	2850	2650	2600	2450	2350 ₅
	90	3250	2700	2400	2950	2550	2300 ₁₀	2500	2300 ₁₀	2100 ₂₅
2/190x35	40	3850	3500	3250	3450	3200	3000	2900 ₅	2750 ₁₀	2650 ₁₅
	90	3650	3050	2700 ₁₀	3250	2850	2600 ₂₀	2800 ₅	2550 ₂₀	2350 ₃₅
2/200x35	40	4000	3650	3400	3600	3350	3150	3050 ₁₀	2900 ₁₅	2800 ₂₀
	90	3750	3200	2850 ₁₅	3450	3000 ₅	2700 ₂₅	2950 ₁₀	2700 ₂₅	2500 ₄₅
2/240x35	40	4550	4200	3950	4150	3900	3700 ₁₀	3650 ₂₅	3450 ₃₀	3350 ₄₀
	90	4300	3800 ₁₀	3400 ₃₅	4000	3600 ₂₅	3250 ₄₅	3550 ₃₀	3200 ₄₅	2950 ₆₅
2/300x35	40	5400	4950	4650 ₁₅	4900	4600 ₁₅	4400 ₃₀	4300 ₄₅	4150 ₅₅	4000 ₆₅
	90	5100	4450 ₂₅	4100 ₅₅	4700 ₁₀	4250 ₄₀	3950 ₇₅	4200 ₅₀	3900 ₇₅	3600 ₁₀₀
90x42	40	1600	1450	1300	1400	1300	1200	1100	1000	NS
	90	1500	1250	1050	1350	1150	NS	1050	NS	NS
120x42	40	2150	1900	1750	1900	1750	1650	1450 ₅	1350 ₅	1250 ₅
	90	2000	1650	1350 ₅	1800	1550	1200 ₅	1350 ₅	1200 ₁₀	1050 ₁₅
130x42	40	2350	2100	1900	2050	1900	1750	1550 ₁₀	1450 ₁₀	1350 ₁₅
	90	2150	1800	1450 ₁₀	1950	1650 ₁₀	1300 ₁₅	1500 ₁₀	1300 ₁₅	1100 ₂₀
140x42	40	2500	2250	2050	2200	2050	1900 ₅	1650 ₁₅	1550 ₂₀	1450 ₂₀
	90	2350	1950 ₅	1600 ₂₀	2100	1800 ₁₅	1400 ₂₀	1600 ₂₀	1400 ₂₅	1200 ₃₀
150x42	40	2700	2400	2200	2350	2200	2050 ₁₅	1800 ₂₅	1650 ₂₅	1550 ₃₀
	90	2500	2100 ₁₀	1700 ₂₅	2250	1900 ₂₀	1500 ₃₀	1700 ₂₅	1500 ₃₀	1300 ₄₀
170x42	40	3050	2750	2500 ₁₀	2650 ₅	2450 ₁₅	2300 ₂₅	2000 ₃₅	1850 ₄₀	1750 ₄₀
	90	2850	2350 ₂₅	1900 ₄₀	2550 ₁₀	2100 ₃₀	1700 ₄₀	1950 ₄₀	1700 ₄₅	1450 ₅₀
190x42	40	3400	3050 ₅	2800 ₂₅	3000 ₁₅	2750 ₂₅	2500 ₃₅	2250 ₅₀	2100 ₅₅	1950 ₅₅
	90	3150	2600 ₃₅	2100 ₅₀	2850 ₂₀	2350 ₄₅	1900 ₅₅	2150 ₅₀	1900 ₆₀	1600 ₇₀
200x42	40	3600	3200 ₁₀	2950 ₃₀	3150 ₂₀	2900 ₃₀	2650 ₄₀	2350 ₅₅	2200 ₆₀	2050 ₆₅
	90	3350 ₅	2700 ₄₀	2250 ₆₀	3000 ₂₅	2450 ₅₀	2000 ₆₅	2250 ₆₀	2000 ₆₅	1700 ₇₅
240x42	40	4100 ₅	3800 ₃₀	3500 ₅₀	3700 ₄₀	3450 ₅₀	3100 ₆₀	2750 ₈₀	2600 ₉₀	2450 ₉₅
	90	3900 ₂₀	3200 ₆₀	2650 ₉₀	3550 ₄₅	2900 ₇₅	2400 ₉₅	2700 ₉₀	2350 ₉₅	2000 ₁₀₅
300x42	40	4850 ₂₀	4450 ₄₅	4200 ₇₅	4400 ₆₀	4150 ₇₅	3800 ₁₀₀	3350 ₁₁₅	3250 ₁₂₅	3050 ₁₃₀
	90	4600 ₃₅	3900 ₉₅	3250 ₁₂₅	4250 ₇₀	3550 ₁₁₀	3000 ₁₃₅	3300 ₁₂₅	2950 ₁₃₅	2500 ₁₄₅
2/90x42	40	2050	1800	1650	1750	1650	1550	1500	1400	1350
	90	1900	1550	1400	1700	1450	1350	1450	1300	1200
2/120x42	40	2700	2400	2250	2350	2200	2050	2000	1900	1800
	90	2500	2100	1850	2250	1950	1800	1900	1750	1650
2/130x42	40	2950	2600	2400	2550	2350	2250	2150	2050	1950
	90	2700	2300	2050	2450	2150	1950	2100	1900	1750
2/140x42	40	3150	2850	2600	2750	2550	2400	2300	2200	2100
	90	2950	2450	2200	2650	2300	2100	2250	2050	1900 ₅
2/150x42	40	3350	3050	2800	2950	2750	2550	2500	2350	2250
	90	3150	2650	2350	2800	2450	2250	2400	2200	2050 ₁₅

Floor bearers supporting single storey load bearing wall - sheet and tiled roof

Continuous span [Cont'd]

Floor load width (mm)		1200			2400			4800		
Roof load width (mm)		1500	4500	7500	1500	4500	7500	1500	4500	7500
Member size DxB (mm)	Roof mass (kg/m ²)	Maximum recommended Continuous span floor bearer supporting single storey load bearing wall span (mm)								
2/170x42	40	3750	3450	3150	3350	3100	2900	2800	2700 ₅	2550 ₁₀
	90	3550	3000	2650 ₅	3200	2800	2550 ₁₀	2700 ₅	2500 ₁₀	2300 ₂₅
2/190x42	40	4100	3750	3550	3700	3450	3250	3150 ₁₀	3000 ₁₅	2850 ₂₀
	90	3900	3350	2950 ₁₅	3550	3100 ₅	2800 ₂₅	3050 ₁₅	2800 ₂₅	2600 ₄₀
2/200x42	40	4250	3900	3700	3850	3650	3450	3300 ₂₀	3150 ₂₀	3000 ₂₅
	90	4000	3500	3100 ₂₀	3700	3250 ₅	2950 ₂₅	3200 ₂₀	2900 ₃₀	2700 ₄₅
2/240x42	40	4850	4500	4200	4400	4150	3950 ₁₀	3850 ₃₀	3750 ₄₀	3600 ₄₅
	90	4600	4050 ₁₀	3700 ₃₅	4250	3850 ₂₅	3550 ₅₀	3800 ₃₅	3500 ₅₀	3250 ₇₀
2/300x42	40	5750	5300	4950 ₁₅	5200 ₅	4900 ₁₅	4700 ₃₀	4550 ₅₅	4400 ₆₀	4250 ₇₀
	90	5450	4800 ₂₅	4400 ₆₀	5000 ₁₀	4550 ₄₀	4200 ₇₅	4450 ₅₅	4150 ₇₅	3950 ₁₀₅
2/360x42	40	6550	6050 ₁₀	5700 ₂₅	5950 ₂₀	5600 ₃₀	5350 ₄₅	5250 ₇₅	5050 ₈₅	4900 ₉₅
	90	6250	5450 ₄₀	5000 ₈₀	5750 ₂₅	5200 ₆₀	4800 ₁₀₀	5100 ₈₀	4750 ₁₀₀	4500 ₁₃₀
2/400x42	40	7100	6550 ₁₅	6150 ₃₅	6450 ₂₅	6050 ₃₅	5800 ₅₅	5650 ₉₀	5450 ₁₀₀	5300 ₁₀₅
	90	6750 ₁₀	5900 ₅₀	5450 ₉₅	6200 ₃₀	5600 ₇₀	5200 ₁₁₅	5550 ₉₅	5150 ₁₁₅	4900 ₁₄₅
150x58	40	3000	2700	2450	2600	2400	2250	2100 ₁₀	2050 ₁₅	1950 ₂₀
	90	2800	2350	2050 ₁₅	2500	2150 ₅	1900 ₂₀	2050 ₁₀	1900 ₂₀	1600 ₂₅
170x58	40	3400	3050	2800	2950	2750	2600 ₅	2350 ₂₀	2250 ₂₅	2200 ₃₀
	90	3150	2650 ₅	2300 ₂₅	2800	2450 ₁₅	2150 ₃₀	2300 ₂₅	2100 ₃₀	1800 ₄₀
200x58	40	3900	3550	3300 ₁₀	3500	3250 ₁₀	3050 ₂₀	2750 ₃₅	2650 ₄₀	2550 ₄₅
	90	3700	3100 ₂₀	2650 ₄₀	3300 ₅	2900 ₃₀	2500 ₅₀	2650 ₄₀	2450 ₅₀	2150 ₆₀
240x58	40	4450	4100 ₅	3850 ₂₅	4050 ₁₅	3800 ₂₅	3600 ₄₀	3250 ₅₅	3100 ₆₅	3000 ₇₀
	90	4200	3700 ₄₀	3100 ₆₀	3900 ₂₀	3400 ₅₀	2900 ₇₀	3150 ₆₀	2900 ₇₅	2550 ₉₅
300x58	40	5250	4850 ₂₀	4550 ₄₀	4750 ₃₀	4500 ₄₅	4300 ₆₅	3950 ₉₀	3800 ₁₀₀	3650 ₁₀₅
	90	5000 ₁₅	4350 ₆₀	3800 ₉₅	4550 ₄₀	4150 ₈₀	3550 ₁₁₀	3850 ₉₅	3500 ₁₁₀	3150 ₁₃₀
360x58	40	6000 ₁₀	5550 ₃₅	5200 ₆₀	5450 ₄₅	5150 ₆₀	4900 ₉₀	4600 ₁₁₅	4400 ₁₂₅	4200 ₁₃₀
	90	5700 ₂₅	5000 ₈₀	4400 ₁₂₀	5250 ₅₅	4750 ₁₀₅	4150 ₁₃₅	4450 ₁₂₀	4100 ₁₃₅	3650 ₁₆₀
400x58	40	6500 ₁₅	6000 ₄₅	5650 ₇₅	5900 ₆₀	5550 ₇₅	5300 ₁₀₀	5000 ₁₃₀	4800 ₁₄₀	4600 ₁₄₅
	90	6150 ₃₅	5400 ₉₅	4800 ₁₄₀	5650 ₇₀	5150 ₁₂₀	4500 ₁₅₀	4850 ₁₃₅	4450 ₁₅₅	4000 ₁₈₀
450x58	40	7100 ₂₅	6550 ₅₅	6150 ₉₀	6450 ₇₅	6050 ₉₀	5800 ₁₁₅	5500 ₁₅₀	5250 ₁₆₀	5050 ₁₇₀
	90	6750 ₄₅	5900 ₁₁₀	5300 ₁₆₀	6200 ₈₅	5600 ₁₃₅	4950 ₁₇₀	5350 ₁₅₅	4900 ₁₇₅	4400 ₂₀₀
240x75	40	4650	4250	4000	4200	3950	3800 ₁₀	3550 ₂₀	3400 ₂₅	3200 ₂₅
	90	4400	3850 ₅	3300 ₂₅	4050	3600 ₁₅	3100 ₃₀	3450 ₂₀	3050 ₃₀	2750 ₄₅
300x75	40	5500	5050	4750 ₁₀	5000	4700 ₁₀	4450 ₂₅	4350 ₄₀	4150 ₄₅	3950 ₅₀
	90	5200	4550 ₂₀	4050 ₄₅	4800 ₅	4300 ₃₅	3800 ₅₅	4200 ₄₀	3750 ₆₀	3350 ₇₅
400x75	40	6750	6250 ₁₀	5850 ₃₀	6150 ₁₅	5800 ₃₀	5550 ₅₀	5400 ₇₀	5200 ₈₀	4950 ₉₀
	90	6400 ₅	5600 ₄₅	5100 ₈₅	5950 ₂₅	5350 ₆₅	4750 ₉₅	5300 ₇₅	4700 ₁₀₀	4200 ₁₁₅
525x75	40	8250 ₁₀	7650 ₃₅	7200 ₅₅	7550 ₃₅	7100 ₆₀	6800 ₈₀	6650 ₁₀₅	6400 ₁₁₅	6200 ₁₃₀
	90	7850 ₂₅	6900 ₇₅	6300 ₁₂₀	7250 ₅₀	6550 ₁₀₀	5950 ₁₃₅	6500 ₁₁₀	5900 ₁₃₅	5250 ₁₆₀
300x82	40	5650	5200 ₁₀	4900 ₂₅	5150 ₁₅	4850 ₂₅	4650 ₄₀	4250 ₅₅	4050 ₆₀	3900 ₆₅
	90	5350 ₅	4700 ₃₅	4050 ₆₀	4950 ₂₀	4400 ₅₀	3800 ₇₀	4100 ₅₅	3750 ₇₀	3350 ₉₅
400x82	40	7000 ₅	6450 ₂₅	6100 ₄₅	6350 ₃₅	6000 ₄₅	5750 ₆₅	5450 ₁₀₀	5250 ₁₁₀	5050 ₁₁₅
	90	6650 ₂₀	5850 ₆₀	5250 ₁₁₀	6150 ₄₀	5550 ₉₀	4900 ₁₂₀	5300 ₁₀₅	4850 ₁₂₀	4350 ₁₄₅

NOTES:

- Sizes in italics are SmartLVL 14
- D = member depth, B = member breadth, NS = not suitable.
- The above table was based on total ground floor mass of 40 kg/m² + 0.5 kPa of LL, wall mass of 37 kg/m², floor live load of 1.5 kPa, floor point load of 1.8 kN
- The above table was based on a wall height of 2700 mm
- End bearing lengths = 42 mm at end supports and 58 mm at internal supports for continuous members. Subscript values indicate the minimum additional bearing length where required to be greater than 42 mm at end supports and 58 mm at internal supports.
- Restraint value for slenderness calculations is 600 mm
- Not all sizes of SmartLVL in this table are stocked in each state. Please check with your supplier before ordering WA only

Single span floor bearer supporting double storey load bearing wall - sheet and tile roof

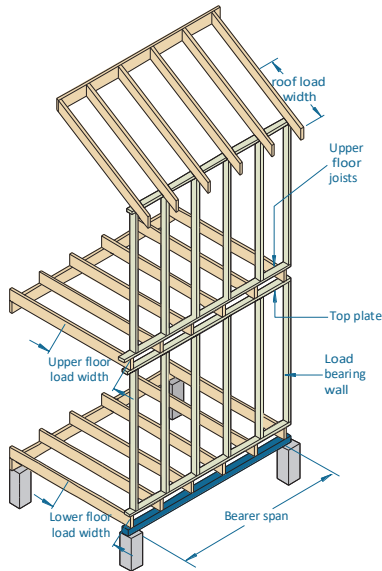

EXAMPLE:

sheet roof - 40 kg/m²
 roof load width = 1950 mm
 bearer span = 3100 mm (single span)
 lower floor load width = 3500 mm
 upper floor load width = 1500 mm

Enter single span table at 3600 mm in lower floor load width column, 1800 mm in upper floor width column, 4500 mm roof load width column, read down to a span equal to or greater than 3100 mm in the 40 kg/m² row.

ADOPT:

SmartLVL 15 - 2/360x42
 (With additional bearing length of 30 mm required)

Lower floor load width (mm)		1800						3600					
Upper floor load width (mm)		1800			3600			1800			3600		
Roof load width (mm)		1500	4500	7500	1500	4500	7500	1500	4500	7500	1500	4500	7500
Member size DxB (mm)	Roof mass (kg/m ²)	Maximum recommended floor bearer supporting double loadbearing wall span (mm)											
		Single span											
2/120x35	40	1400	1350	1250	1300	1250	1200	1250	1200	1150	1200	1150	1100
	90	1350	1200	1150	1250	1150	1100	1250	1150	1050	1150	1100	1000
2/130x35	40	1550	1450	1400	1400	1350	1300	1400	1300	1250	1300	1250	1200
	90	1500	1350	1200	1400	1250	1150	1350	1250	1150	1250	1200	1100
2/140x35	40	1650	1550	1500	1550	1450	1400	1500	1450	1350	1400	1350	1300
	90	1600	1450	1300	1500	1350	1250	1450	1350	1250	1350	1250	1200
2/150x35	40	1800	1700	1600	1650	1550	1500	1600	1550	1450	1500	1450	1400
	90	1700	1550	1400	1600	1450	1350	1550	1450	1350	1450	1350	1300
2/170x35	40	2000	1900	1800	1850	1800	1700	1800	1750	1650	1700	1650	1600
	90	1950	1750	1600	1800	1650	1550	1750	1600	1500	1650	1550	1450
2/190x35	40	2250	2150	2050	2100	2000	1900	2050	1950	1850	1900	1850	1800
	90	2150	1950	1800	2000	1850	1700	1950	1800	1700	1850	1750	1650
2/200x35	40	2400	2250	2150	2200	2100	2000	2150	2050	1950	2000	1950	1900
	90	2300	2050	1900	2150	1950	1800	2100	1900	1800	1950	1850	1700
2/240x35	40	2850	2700	2550	2650	2500	2400	2550	2450	2350	2400	2350	2250
	90	2750	2450	2250	2550	2350	2200	2500	2300	2150	2350	2200	2050 ₅
2/300x35	40	3550	3350	3200	3300	3150	3000	3200	3050 ₅	2950 ₅	3050 ₅	2900 ₁₀	2800 ₁₀
	90	3450	3100	2850 ₅	3200	2950 ₅	2750 ₁₀	3100 ₅	2850 ₅	2700 ₁₀	2950 ₁₀	2750 ₁₀	2600 ₁₅
120x42	40	1300	1200	1200	1200	1100	1100	1200	1100	1100	1100	1000	1000
	90	1300	1100	1000	1100	1000	NS	1100	1000	NS	1100	1000	NS
130x42	40	1500	1300	1300	1300	1200	1200	1300	1200	1200	1200	1100	1100
	90	1400	1200	1100	1200	1100	1000	1200	1100	1000	1100	1000	1000
140x42	40	1600	1500	1400	1400	1300	1200	1400	1300	1300	1300	1200	1200
	90	1500	1300	1200	1300	1200	1100	1300	1200	1100	1200	1100	1100
150x42	40	1700	1600	1500	1500	1400	1300	1500	1400	1400	1400	1300	1300
	90	1600	1400	1300	1400	1300	1200	1400	1300	1200	1300	1200	1100 ₅
170x42	40	1900	1800	1700	1700	1600	1500	1700	1600	1500	1600	1500	1400
	90	1800	1600	1400	1600	1500	1400 ₅	1600	1500	1400 ₅	1500	1400	1300 ₁₀
190x42	40	2100	2000	1900	1900	1800	1700	1900	1800	1700	1700	1700	1600 ₅
	90	2000	1800	1600 ₅	1800	1600 ₅	1500 ₁₀	1800	1700	1500 ₁₀	1700	1600 ₅	1500 ₁₅
200x42	40	2300	2100	2000	2000	1900	1800	2000	1900	1800	1800	1800 ₅	1700 ₅
	90	2100	1900	1700 ₅	1900	1700 ₅	1600 ₁₀	1900	1700 ₅	1600 ₁₀	1800 ₅	1600 ₁₀	1500 ₁₅
240x42	40	2700	2500	2400	2400	2300 ₅	2200 ₁₀	2400 ₅	2300 ₅	2200 ₁₀	2200 ₁₀	2100 ₁₀	2000 ₁₅
	90	2600	2300 ₅	2100 ₁₅	2300 ₅	2100 ₁₅	1900 ₂₅	2300 ₅	2100 ₁₅	1900 ₂₀	2200 ₁₀	2000 ₂₀	1800 ₃₀
300x42	40	3400	3200 ₅	3000 ₁₅	3000 ₁₀	2900 ₁₅	2700 ₂₅	3000 ₁₅	2900 ₂₀	2700 ₂₀	2800 ₂₀	2700 ₂₅	2600 ₃₀
	90	3200 ₅	2800 ₂₀	2600 ₃₀	2900 ₁₅	2600 ₃₀	2400 ₄₀	2900 ₂₀	2600 ₂₅	2400 ₄₀	2700 ₂₅	2500 ₃₅	2300 ₄₅

Single span floor bearer supporting double storey load bearing wall - sheet & tile roof (cont'd)

Lower floor load width (mm)		1800						3600					
Upper floor load width (mm)		1800			3600			1800			3600		
Roof load width (mm)		1500	4500	7500	1500	4500	7500	1500	4500	7500	1500	4500	7500
Member size DxB (mm)	Roof mass (kg/m ²)	Maximum recommended floor bearer supporting double loadbearing wall span (mm)											
		Single span											
2/120x42	40	1700	1600	1500	1500	1400	1400	1500	1400	1400	1400	1300	1300
	90	1600	1400	1300	1400	1300	1200	1500	1300	1200	1300	1200	1100
2/130x42	40	1800	1700	1600	1600	1500	1500	1600	1600	1500	1500	1400	1400
	90	1700	1500	1400	1600	1400	1300	1600	1400	1300	1500	1300	1200
2/140x42	40	2000	1800	1700	1800	1700	1600	1800	1700	1600	1600	1500	1500
	90	1900	1600	1500	1700	1500	1400	1700	1500	1400	1600	1400	1300
2/150x42	40	2100	2000	1900	1900	1800	1700	1900	1800	1700	1700	1700	1600
	90	2000	1800	1600	1800	1600	1500	1800	1600	1500	1700	1500	1400
2/170x42	40	2400	2200	2100	2100	2000	1900	2200	2000	1900	2000	1900	1800
	90	2300	2000	1800	2100	1900	1700	2100	1900	1700	1900	1800	1600
2/190x42	40	2700	2500	2400	2400	2300	2200	2400	2300	2200	2200	2100	2000
	90	2600	2200	2000	2300	2100	1900	2300	2100	1900	2100	2000	1800
2/200x42	40	2900	2600	2500	2500	2400	2300	2600	2400	2300	2300	2200	2100
	90	2700	2400	2200	2400	2200	2000	2500	2200	2000	2300	2100	1900
2/240x42	40	3400	3200	3000	3000	2900	2700	3100	2900	2800	2800	2700	2600
	90	3300	2900	2600	2900	2600	2400	3000	2700	2500	2700	2500	2300 ₅
2/300x42	40	4100	3900	3700	3700	3600	3400	3800	3600	3500	3500	3400	3200 ₅
	90	3900	3600	3200 ₅	3600	3300	3100 ₁₀	3700	3300	3100 ₁₀	3400	3100 ₁₀	2900 ₁₅
2/360x42	40	4700	4400	4200	4300	4100	4000 ₅	4300	4100 ₅	4000 ₅	4000 ₅	3900 ₁₀	3800 ₁₀
	90	4500	4100	3800 ₁₀	4200	3900 ₁₀	3700 ₂₀	4200	3900 ₁₀	3700 ₂₀	4000 ₅	3700 ₁₅	3500 ₂₅
2/400x42	40	5100	4800	4600	4600	4500 ₅	4300 ₁₀	4700 ₅	4500 ₅	4300 ₁₀	4400 ₁₀	4200 ₁₀	4100 ₁₅
	90	4900	4400 ₅	4100 ₁₅	4500 ₅	4200 ₁₅	4000 ₂₅	4600 ₅	4200 ₁₅	4000 ₂₅	4300 ₁₀	4000 ₂₀	3800 ₃₀
90x58	40	1100	1000	1000	1000	NS	NS	1000	NS	NS	NS	NS	NS
	90	1100	NS	NS	NS	NS	NS	NS	NS	NS	NS	NS	NS
130x58	40	1600	1500	1400	1400	1400	1300	1400	1400	1300	1300	1300	1200
	90	1500	1300	1200	1400	1200	1100	1400	1300	1200	1300	1200	1100
150x58	40	1900	1700	1600	1700	1600	1500	1700	1600	1500	1500	1500	1400
	90	1800	1600	1400	1600	1400	1300	1600	1500	1300	1500	1400	1300
170x58	40	2100	2000	1900	1900	1800	1700	1900	1800	1700	1700	1700	1600
	90	2000	1800	1600	1800	1600	1500	1800	1700	1500	1700	1600	1400
200x58	40	2500	2300	2200	2200	2100	2000	2300	2100	2000	2100	2000	1900
	90	2400	2100	1900	2200	1900	1800	2200	2000	1800	2000	1800	1700 ₅
240x58	40	3000	2800	2600	2700	2500	2400	2700	2600	2400	2500	2400	2300 ₅
	90	2900	2500	2300 ₅	2600	2300 ₅	2200 ₁₀	2600	2400 ₅	2200 ₁₀	2400	2200 ₁₀	2100 ₁₅
300x58	40	3700	3500	3300	3400	3200 ₅	3000 ₁₀	3400 ₅	3200 ₅	3100 ₁₀	3100 ₁₀	3000 ₁₅	2900 ₁₅
	90	3600	3200 ₅	2900 ₁₅	3200 ₅	2900 ₁₅	2700 ₂₅	3300 ₅	2900 ₁₅	2700 ₂₀	3000 ₁₀	2800 ₂₀	2600 ₃₀
360x58	40	4300	4000 ₅	3900 ₁₀	3900 ₁₀	3800 ₁₅	3600 ₂₀	3900 ₁₅	3800 ₁₅	3600 ₂₀	3700 ₂₀	3600 ₂₅	3400 ₃₀
	90	4100	3700 ₁₅	3500 ₃₀	3800 ₁₀	3500 ₂₅	3300 ₃₅	3800 ₁₅	3500 ₂₅	3300 ₃₅	3600 ₂₀	3300 ₃₀	3100 ₄₀
400x58	40	4600	4400 ₅	4200 ₁₅	4200 ₁₀	4100 ₂₀	3900 ₂₅	4300 ₁₅	4100 ₂₀	3900 ₂₅	4000 ₂₅	3900 ₃₀	3800 ₃₅
	90	4500 ₅	4000 ₂₀	3800 ₃₅	4100 ₁₅	3800 ₃₀	3600 ₄₅	4200 ₂₀	3800 ₃₀	3600 ₄₅	3900 ₂₅	3700 ₄₀	3500 ₅₀
450x58	40	5100 ₅	4800 ₁₀	4600 ₂₀	4600 ₁₅	4400 ₂₅	4300 ₃₀	4700 ₂₀	4500 ₂₅	4300 ₃₀	4400 ₃₀	4200 ₃₅	4100 ₄₀
	90	4900 ₁₀	4400 ₂₅	4100 ₄₀	4500 ₂₀	4200 ₃₅	3900 ₅₀	4500 ₂₅	4200 ₃₅	4000 ₅₀	4300 ₃₅	4000 ₄₅	3800 ₆₀
240x75	40	2900	2750	2600	2700	2600	2450	2650	2500	2400	2500	2400	2300
	90	2800	2500	2350	2600	2400	2250	2550	2350	2200	2400	2250	2100
300x75	40	3650	3450	3250	3350	3200	3100	3300	3150	3000 ₅	3100 ₅	3000 ₅	2900 ₁₀
	90	3500	3150	2900 ₅	3250	3000	2800 ₅	3200	2950 ₅	2750 ₁₀	3000 ₅	2800 ₁₀	2650 ₁₀
400x75	40	4500	4300	4150 ₅	4250 ₅	4100 ₁₀	4000 ₁₀	4150 ₁₀	4050 ₁₅	3900 ₁₅	4000 ₂₀	3900 ₂₀	3800 ₂₅
	90	4350	4050 ₅	3800 ₁₅	4150 ₅	3900 ₁₅	3700 ₂₀	4100 ₁₀	3850 ₂₀	3650 ₂₅	3900 ₂₀	3700 ₂₅	3550 ₃₀
525x75	40	5500 ₅	5250 ₁₀	5100 ₁₅	5200 ₁₅	5000 ₂₀	4850 ₂₀	5100 ₂₀	4950 ₂₅	4800 ₃₀	4900 ₃₀	4750 ₃₅	4650 ₃₅
	90	5350 ₁₀	4950 ₂₀	4650 ₃₀	5100 ₂₀	4750 ₂₅	4500 ₃₅	5000 ₂₅	4700 ₃₀	4450 ₄₀	4800 ₃₀	4550 ₄₀	4350 ₄₅
300x82	40	3800	3600	3450	3550	3400	3250 ₅	3450	3300	3200 ₅	3250 ₅	3150 ₅	3050 ₁₀
	90	3700	3300	3050 ₅	3450	3150 ₅	2950 ₅	3350	3100 ₅	2900 ₁₅	3200 ₅	2950 ₁₀	2800 ₁₅
400x82	40	4700	4500 ₅	4300 ₁₀	4400 ₅	4250 ₁₀	4150 ₁₅	4350 ₁₀	4200 ₁₀	4100 ₁₅	4150 ₁₅	4050 ₂₀	3950 ₂₀
	90	4550	4200 ₁₀	3950 ₂₀	4300 ₁₀	4050 ₂₀	3850 ₃₀	4250 ₁₀	4000 ₂₀	3800 ₃₀	4100 ₁₅	3850 ₂₅	3700 ₃₅

Continuous span floor bearer supporting double storey load bearing wall - sheet & tile roof

Lower floor load width (mm)		1800						3600					
Upper floor load width (mm)		1800			3600			1800			3600		
Roof load width (mm)		1500	4500	7500	1500	4500	7500	1500	4500	7500	1500	4500	7500
Member size DxB (mm)	Roof mass (kg/m ²)	Maximum recommended floor bearer supporting double loadbearing wall span (mm)											
		Continuous span											
2/90x35	40	1450	1350	1300	1350	1250	1200	1300	1250	1200	1200	1200	1150
	90	1400	1250	1150	1300	1200	1100	1250	1150	1100	1200	1100	1050
2/120x35	40	1950	1800	1750	1800	1700	1650	1750	1650	1600	1650	1600	1550
	90	1850	1650	1550	1750	1600	1450	1700	1550	1450	1600	1500	1400 ₅
2/130x35	40	2100	2000	1900	1950	1850	1750	1900	1800	1750	1800	1700	1650
	90	2000	1800	1650	1900	1700	1600	1850	1700	1550 ₅	1750	1600 ₅	1500 ₁₀
2/140x35	40	2250	2150	2050	2100	2000	1900	2050	1950	1850	1900 ₅	1850 ₅	1800 ₁₀
	90	2200	1950	1800	2050	1850	1700 ₅	1950	1800	1700 ₁₀	1850 ₅	1750 ₁₀	1650 ₂₀
2/150x35	40	2400	2300	2150	2250	2150	2050	2200	2100 ₅	2000 ₅	2050 ₁₀	2000 ₁₅	1900 ₁₅
	90	2350	2100	1950 ₅	2150	2000	1850 ₁₅	2100	1950 ₁₀	1800 ₁₅	2000 ₁₀	1850 ₂₀	1750 ₂₅
2/170x35	40	2750	2600	2450	2550	2400 ₅	2350 ₁₀	2450 ₁₀	2350 ₁₅	2300 ₂₀	2300 ₂₀	2200 ₂₅	2150 ₂₅
	90	2650	2350	2200 ₂₀	2450 ₅	2250 ₁₀	2100 ₂₅	2400 ₁₀	2200 ₂₀	2050 ₃₀	2250 ₂₅	2100 ₃₀	1950 ₃₅
2/190x35	40	3050	2900	2750 ₅	2850 ₁₀	2700 ₁₅	2600 ₂₀	2750 ₂₀	2650 ₂₅	2550 ₃₀	2550 ₃₀	2450 ₃₅	2400 ₄₀
	90	2950	2650 ₁₀	2450 ₃₀	2750 ₁₅	2500 ₂₅	2350 ₄₀	2700 ₂₅	2450 ₃₀	2300 ₄₀	2500 ₃₅	2300 ₄₀	2150 ₅₀
2/200x35	40	3250	3050 ₅	2900 ₁₀	3000 ₁₅	2850 ₂₀	2750 ₂₅	2900 ₂₅	2800 ₃₀	2700 ₃₅	2650 ₃₅	2550 ₄₀	2500 ₄₅
	90	3100 ₅	2800 ₂₀	2600 ₃₅	2900 ₂₀	2650 ₃₀	2450 ₄₅	2850 ₃₀	2600 ₄₀	2400 ₄₅	2600 ₄₀	2400 ₄₅	2250 ₅₅
2/240x35	40	3800 ₁₅	3650 ₂₅	3500 ₃₀	3600 ₃₅	3400 ₄₀	3300 ₄₅	3450 ₄₅	3300 ₅₀	3150 ₅₅	3150 ₅₅	3050 ₆₀	2950 ₆₅
	90	3700 ₂₀	3350 ₃₅	3100 ₆₀	3500 ₄₀	3200 ₅₀	2900 ₆₅	3350 ₅₀	3050 ₆₀	2850 ₇₀	3050 ₆₀	2850 ₇₀	2700 ₈₀
2/300x35	40	4500 ₃₀	4300 ₄₀	4150 ₅₀	4250 ₅₅	4100 ₆₅	3950 ₇₀	4150 ₇₀	4000 ₈₀	3850 ₉₀	3850 ₉₀	3700 ₉₅	3600 ₁₀₀
	90	4350 ₃₅	4050 ₆₀	3800 ₉₅	4150 ₆₀	3900 ₈₀	3550 ₁₀₀	4050 ₇₅	3750 ₉₅	3500 ₁₀₅	3750 ₉₅	3500 ₁₀₅	3300 ₁₁₅
90x42	40	1400	1300	1200	1200	1100	1100	1100	1100	1000	1000	NS	NS
	90	1300	1100	NS	1200	1000	NS	1100	NS	NS	NS	NS	NS
120x42	40	1800	1700	1600	1600	1500	1400 ₅	1500	1400 ₅	1300 ₅	1300 ₅	1200 ₅	1100 ₅
	90	1700	1500	1200 ₅	1600	1300 ₅	1000 ₁₀	1500 ₅	1200 ₅	1000 ₁₀	1300 ₁₀	1100 ₁₀	1000 ₁₅
130x42	40	2000	1800	1700	1800	1700 ₅	1500 ₁₀	1600 ₁₀	1500 ₁₀	1400 ₁₀	1400 ₁₀	1300 ₁₅	1200 ₁₅
	90	1900	1600 ₁₀	1300 ₁₅	1700 ₅	1400 ₁₀	1200 ₁₅	1600 ₁₀	1300 ₁₅	1200 ₁₅	1400 ₁₅	1200 ₁₅	1100 ₂₅
140x42	40	2100	2000	1900 ₅	1900 ₅	1800 ₁₅	1600 ₂₀	1800 ₁₅	1600 ₂₀	1500 ₂₀	1500 ₂₀	1400 ₂₀	1300 ₂₀
	90	2000	1800 ₁₅	1400 ₂₀	1800 ₁₀	1500 ₂₀	1300 ₂₀	1700 ₁₅	1500 ₂₅	1300 ₂₀	1500 ₂₀	1200 ₂₀	1100 ₃₀
150x42	40	2300	2100 ₅	2000 ₁₅	2000 ₁₅	1900 ₂₀	1800 ₂₅	1900 ₂₀	1800 ₂₅	1600 ₂₅	1600 ₂₅	1500 ₃₀	1400 ₃₀
	90	2200	1900 ₂₀	1500 ₃₀	1900 ₂₀	1600 ₂₅	1300 ₃₅	1800 ₂₅	1600 ₃₀	1300 ₃₀	1600 ₃₀	1300 ₃₀	1200 ₃₅
170x42	40	2600 ₁₀	2400 ₂₀	2300 ₂₅	2300 ₂₅	2100 ₃₀	2000 ₃₅	2100 ₃₀	2000 ₃₅	1900 ₄₀	1900 ₄₀	1700 ₄₀	1600 ₄₀
	90	2500 ₁₅	2100 ₃₀	1700 ₄₀	2200 ₃₀	1800 ₄₀	1500 ₄₅	2000 ₃₅	1800 ₄₀	1500 ₅₀	1800 ₄₀	1500 ₄₀	1400 ₅₀
190x42	40	2900 ₂₀	2700 ₃₀	2500 ₃₅	2500 ₃₅	2400 ₄₀	2200 ₅₀	2300 ₄₅	2200 ₅₀	2100 ₅₀	2100 ₅₅	1900 ₅₅	1800 ₅₅
	90	2800 ₂₅	2300 ₄₅	1900 ₅₅	2400 ₄₀	2000 ₅₀	1700 ₆₀	2300 ₅₀	2000 ₅₅	1700 ₆₅	2000 ₅₅	1700 ₅₅	1600 ₇₀
200x42	40	3100 ₂₅	2800 ₃₀	2600 ₄₀	2600 ₄₀	2500 ₅₀	2300 ₅₅	2400 ₅₀	2300 ₅₅	2200 ₆₀	2200 ₆₀	2000 ₆₀	1900 ₆₅
	90	2900 ₃₀	2500 ₅₀	2000 ₆₀	2500 ₄₅	2200 ₆₅	1700 ₇₀	2400 ₅₅	2100 ₆₅	1800 ₆₅	2100 ₆₀	1800 ₆₅	1600 ₇₅
240x42	40	3600 ₄₀	3300 ₅₀	3100 ₆₀	3100 ₆₀	2900 ₇₀	2700 ₈₅	2900 ₇₅	2800 ₈₅	2600 ₉₀	2600 ₉₀	2400 ₉₅	2300 ₉₅
	90	3400 ₅₀	2900 ₇₅	2500 ₉₅	3000 ₇₀	2600 ₉₅	2100 ₁₀₅	2800 ₈₀	2500 ₉₅	2100 ₁₀₀	2500 ₉₀	2200 ₁₀₀	2000 ₁₁₀
300x42	40	4300 ₇₀	4100 ₈₅	3800 ₁₀₀	3800 ₁₀₀	3600 ₁₀₅	3400 ₁₂₀	3500 ₁₁₀	3400 ₁₂₀	3200 ₁₂₅	3200 ₁₂₅	3000 ₁₃₅	2900 ₁₃₅
	90	4200 ₈₀	3600 ₁₁₀	3100 ₁₃₅	3700 ₁₀₅	3200 ₁₃₀	2600 ₁₄₀	3400 ₁₁₅	3100 ₁₃₀	2700 ₁₄₀	3100 ₁₃₀	2700 ₁₃₅	2400 ₁₅₀
360x42	40	5000 ₉₅	4700 ₁₁₀	4500 ₁₂₅	4500 ₁₂₅	4200 ₁₄₀	3900 ₁₅₀	4100 ₁₃₅	3900 ₁₄₅	3700 ₁₅₅	3700 ₁₅₅	3600 ₁₆₅	3400 ₁₇₀
	90	4800 ₁₀₅	4200 ₁₄₀	3600 ₁₆₅	4300 ₁₃₅	3700 ₁₆₀	3200 ₁₇₅	4000 ₁₄₀	3600 ₁₆₀	3200 ₁₇₅	3600 ₁₆₀	3200 ₁₇₅	2900 ₁₉₀
400x42	40	5400 ₁₀₅	5100 ₁₂₅	4900 ₁₄₀	4900 ₁₄₅	4700 ₁₅₅	4300 ₁₇₀	4500 ₁₅₅	4300 ₁₆₅	4100 ₁₇₅	4100 ₁₇₅	3900 ₁₈₅	3700 ₁₉₅
	90	5200 ₁₁₅	4600 ₁₅₅	3900 ₁₈₅	4800 ₁₅₅	4100 ₁₈₀	3600 ₂₀₅	4300 ₁₆₀	3900 ₁₈₀	3600 ₂₀₀	3900 ₁₈₀	3600 ₂₀₀	3200 ₂₁₅
2/90x42	40	1700	1600	1500	1500	1400	1400	1500	1500	1400	1400	1300	1300
	90	1600	1400	1300	1500	1300	1200	1500	1300	1200	1400	1300	1200
2/120x42	40	2300	2100	2000	2100	1900	1900	2100	2000	1900	1900	1800	1700
	90	2200	1900	1700	2000	1800	1600	2000	1800	1700	1800	1700	1600
2/130x42	40	2500	2300	2200	2200	2100	2000	2200	2100	2000	2100	2000	1900
	90	2400	2100	1900	2100	1900	1800	2200	1900	1800	2000	1800	1700
2/140x42	40	2700	2500	2400	2400	2300	2200	2400	2300	2200	2200	2100	2000
	90	2600	2300	2000	2300	2100	1900	2300	2100	1900	2200	2000	1800 ₁₀
2/150x42	40	2900	2700	2500	2600	2400	2300	2600	2500	2300	2400	2300	2200 ₅
	90	2800	2400	2200	2500	2200	2100 ₅	2500	2300	2100 ₅	2300	2100 ₅	2000 ₁₅
2/170x42	40	3300	3100	2900	2900	2800	2600	3000	2800	2700 ₅	2700 ₅	2600 ₁₀	2500 ₁₅
	90	3100	2700	2500 ₁₀	2800	2500 ₅	2400 ₂₀	2800	2600 ₁₀	2400 ₂₀	2600 ₁₀	2400 ₂₀	2200 ₃₀
2/190x42	40	3700	3400	3200	3300	3100	3000 ₁₀	3300 ₅	3100 ₁₀	3000 ₁₅	3000 ₂₀	2900 ₂₅	2800 ₂₅
	90	3500	3100	2800 ₂₀	3200	2800 ₁₅	2600 ₃₀	3200 ₁₀	2900 ₂₀	2600 ₃₀	2900 ₂₅	2700 ₃₀	2500 ₄₀
2/200x42	40	3800	3600	3400	3400	3300 ₅	3100 ₁₅	3500 ₁₅	3300 ₁₅	3100 ₂₅	3200 ₂₅	3000 ₃₀	2900 ₃₀
	90	3700	3200 ₅	2900 ₂₅	3300 ₅	3000 ₂₀	2800 ₃₅	3400 ₁₅	3000 ₂₅	2800 ₃₅	3100 ₂₅	2800 ₃₅	2700 ₄₅
2/240x42	40	4400	4100 ₅	3900 ₁₀	4000 ₁₀	3800 ₂₀	3700 ₃₀	4000 ₂₅	3800 ₃₅	3700 ₄₀	3800 ₄₀	3600 ₅₀	3500 ₅₅
	90	4200	3800 ₂₀	3500 ₄₅	3900 ₂₀	3600 ₄₀	3300 ₆₀	3900 ₃₀	3600 ₄₅	3400 ₆₀	3700 ₄₅	3400 ₅₅	3200 ₇₅

Continuous span floor bearer supporting double storey load bearing wall - sheet & tile roof (cont'd)

Lower floor load width (mm)		1800						3600					
Upper floor load width (mm)		1800			3600			1800			3600		
Roof load width (mm)		1500	4500	7500	1500	4500	7500	1500	4500	7500	1500	4500	7500
Member size DxB	Roof mass (kg/m ²)	Maximum recommended floor bearer supporting double loadbearing wall span (mm)											
		Continuous span											
2/300x42	40	5200 ₁₀	4900 ₂₀	4700 ₃₀	4700 ₃₀	4500 ₄₀	4400 ₅₀	4700 ₄₅	4600 ₅₅	4400 ₆₀	4400 ₆₅	4300 ₇₀	4200 ₈₀
	90	5000 ₁₅	4500 ₄₀	4200 ₆₅	4600 ₃₅	4300 ₆₀	4000 ₉₀	4600 ₅₀	4300 ₇₀	4000 ₉₀	4300 ₇₀	4100 ₈₅	3900 ₁₀₅
2/360x42	40	5900 ₂₅	5600 ₃₀	5300 ₄₅	5400 ₄₅	5200 ₅₅	5000 ₇₀	5400 ₆₅	5200 ₇₅	5000 ₈₅	5100 ₉₀	4900 ₁₀₀	4800 ₁₀₅
	90	5700 ₃₀	5200 ₆₀	4800 ₉₅	5300 ₅₀	4900 ₈₅	4600 ₁₁₅	5300 ₇₀	4900 ₉₀	4600 ₁₁₅	5000 ₉₅	4700 ₁₁₀	4500 ₁₃₅
2/400x42	40	6400 ₃₀	6000 ₄₀	5800 ₅₅	5900 ₅₅	5600 ₆₅	5400 ₈₅	5900 ₈₀	5700 ₉₀	5500 ₁₀₀	5500 ₁₀₀	5300 ₁₁₀	5200 ₁₁₅
	90	6200 ₄₀	5600 ₇₀	5200 ₁₀₅	5700 ₆₅	5300 ₁₀₀	5000 ₁₃₀	5700 ₈₅	5300 ₁₀₅	5000 ₁₂₅	5400 ₁₁₀	5100 ₁₂₅	4800 ₁₅₀
90x58	40	1500	1400	1300	1300	1300	1200	1400	1300	1200	1200	1200	1100
	90	1400	1300	1100	1300	1200	1000	1300	1200	1000	1200	1100	NS
130x58	40	2200	2100	1900	2000	1900	1800	1900	1800	1800 ₅	1800 ₅	1700 ₅	1600 ₁₀
	90	2100	1800	1700 ₅	1900	1700	1500 ₁₀	1900	1700 ₅	1500 ₁₀	1700 ₅	1500 ₁₀	1300 ₁₅
150x58	40	2600	2400	2200	2300	2200	2100 ₁₀	2200 ₅	2100 ₁₀	2000 ₁₅	2000 ₁₅	1900 ₂₀	1800 ₂₅
	90	2400	2100 ₅	1900 ₂₀	2200	2000 ₁₅	1700 ₂₅	2100 ₁₀	1900 ₂₀	1700 ₂₅	1900 ₂₀	1800 ₂₅	1600 ₃₀
170x58	40	2900	2700	2500 ₅	2600 ₅	2400 ₁₅	2300 ₂₅	2500 ₁₅	2400 ₂₀	2300 ₂₅	2200 ₃₀	2200 ₃₀	2100 ₃₅
	90	2800	2400 ₁₅	2200 ₃₀	2500 ₁₀	2200 ₂₅	2000 ₄₀	2400 ₂₀	2200 ₃₀	2000 ₃₅	2200 ₃₀	2000 ₃₅	1800 ₄₀
200x58	40	3400 ₅	3200 ₁₀	3000 ₂₀	3000 ₂₅	2900 ₃₀	2700 ₃₅	2900 ₃₀	2700 ₃₅	2600 ₄₀	2600 ₄₀	2500 ₄₅	2400 ₅₀
	90	3300 ₁₀	2900 ₃₀	2500 ₄₅	2900 ₃₀	2600 ₄₀	2300 ₅₅	2800 ₃₅	2500 ₄₅	2300 ₅₅	2500 ₄₅	2300 ₅₅	2100 ₆₅
240x58	40	4000 ₂₀	3800 ₃₀	3600 ₄₀	3600 ₄₅	3400 ₅₀	3200 ₅₅	3400 ₅₀	3200 ₅₅	3100 ₆₀	3100 ₆₅	3000 ₇₀	2800 ₇₅
	90	3800 ₂₅	3400 ₅₀	3000 ₇₀	3500 ₄₅	3100 ₆₅	2700 ₈₅	3300 ₅₅	3000 ₇₀	2700 ₈₅	3000 ₆₅	2800 ₈₅	2500 ₉₅
300x58	40	4700 ₃₅	4400 ₅₀	4200 ₆₅	4300 ₆₅	4100 ₇₅	4000 ₉₅	4200 ₈₀	4000 ₉₀	3800 ₁₀₀	3800 ₁₀₀	3600 ₁₀₅	3500 ₁₁₅
	90	4500 ₄₅	4100 ₈₀	3600 ₁₀₅	4200 ₇₀	3800 ₁₀₅	3300 ₁₂₀	4000 ₈₅	3700 ₁₀₅	3300 ₁₂₀	3700 ₁₀₅	3400 ₁₂₀	3100 ₁₃₀
360x58	40	5400 ₅₅	5100 ₇₀	4900 ₈₅	4900 ₉₀	4700 ₁₀₀	4600 ₁₁₅	4800 ₁₀₅	4600 ₁₁₅	4400 ₁₂₅	4400 ₁₂₅	4200 ₁₃₀	4000 ₁₄₀
	90	5200 ₆₀	4700 ₁₀₀	4300 ₁₃₅	4800 ₉₅	4400 ₁₃₀	3900 ₁₅₀	4700 ₁₁₅	4200 ₁₃₀	3900 ₁₅₀	4300 ₁₃₀	3900 ₁₄₅	3600 ₁₆₀
400x58	40	5800 ₆₅	5500 ₈₀	5300 ₁₀₀	5300 ₁₀₅	5100 ₁₁₅	5000 ₁₃₅	5300 ₁₂₅	5000 ₁₃₀	4800 ₁₄₀	4800 ₁₄₀	4600 ₁₅₀	4400 ₁₅₅
	90	5600 ₇₅	5100 ₁₁₅	4700 ₁₅₅	5200 ₁₁₀	4800 ₁₅₀	4300 ₁₇₀	5100 ₁₂₅	4600 ₁₄₅	4200 ₁₆₅	4600 ₁₄₅	4300 ₁₆₅	3900 ₁₈₀
450x58	40	6400 ₈₀	6000 ₁₀₀	5800 ₁₁₅	5800 ₁₂₀	5600 ₁₃₀	5400 ₁₅₀	5800 ₁₄₀	5500 ₁₅₀	5300 ₁₆₀	5200 ₁₆₀	5000 ₁₇₀	4800 ₁₈₀
	90	6100 ₉₅	5600 ₁₃₅	5200 ₁₇₅	5700 ₁₂₅	5300 ₁₆₅	4800 ₂₀₀	5600 ₁₄₅	5100 ₁₇₀	4600 ₁₈₅	5100 ₁₆₅	4700 ₁₈₅	4300 ₂₀₅
240x75	40	3850 ₁₀	3650 ₁₅	3450 ₂₀	3400 ₂₀	3250 ₂₅	3100 ₃₀	3200 ₃₀	3050 ₃₅	2950 ₃₅	2900 ₄₀	2800 ₄₀	2700 ₄₅
	90	3700 ₁₅	3250 ₂₅	2850 ₄₀	3300 ₂₅	3000 ₃₅	2700 ₄₅	3100 ₃₀	2850 ₄₀	2650 ₅₀	2850 ₄₀	2650 ₅₀	2500 ₆₀
300x75	40	4550 ₂₅	4350 ₃₅	4200 ₄₀	4250 ₄₅	4000 ₅₀	3850 ₅₅	3900 ₅₀	3750 ₆₀	3600 ₆₅	3550 ₆₅	3450 ₇₀	3350 ₇₅
	90	4450 ₃₀	4050 ₅₀	3500 ₆₅	4100 ₅₀	3700 ₆₀	3300 ₇₅	3800 ₅₅	3500 ₇₀	3250 ₈₀	3500 ₇₀	3250 ₈₀	3050 ₉₅
400x75	40	5650 ₅₀	5400 ₆₀	5200 ₇₅	5350 ₈₀	5150 ₉₅	4950 ₁₀₀	4900 ₉₀	4700 ₁₀₀	4550 ₁₀₅	4500 ₁₀₅	4350 ₁₁₀	4200 ₁₁₅
	90	5500 ₆₀	5100 ₉₀	4550 ₁₁₅	5200 ₉₀	4800 ₁₀₅	4250 ₁₂₀	4800 ₉₅	4400 ₁₁₀	4100 ₁₂₀	4400 ₁₁₀	4100 ₁₂₀	3850 ₁₃₅
525x75	40	6900 ₈₅	6650 ₁₀₀	6400 ₁₁₀	6550 ₁₁₅	6300 ₁₃₀	6150 ₁₄₀	6150 ₁₃₀	5900 ₁₃₅	5650 ₁₄₅	5600 ₁₄₅	5450 ₁₅₅	5250 ₁₆₀
	90	6750 ₉₅	6200 ₁₂₅	5800 ₁₆₀	6400 ₁₂₅	6000 ₁₄₅	5450 ₁₇₀	6000 ₁₃₅	5500 ₁₅₀	5100 ₁₆₅	5500 ₁₅₀	5100 ₁₆₅	4800 ₁₈₀
300x82	40	4750 ₂₅	4550 ₄₀	4300 ₅₀	4450 ₄₅	4100 ₅₀	3850 ₆₀	4150 ₄₅	4000 ₅₀	3800 ₅₅	3800 ₅₅	3650 ₆₀	3500 ₇₀
	90	4600 ₃₅	4000 ₅₅	3500 ₇₀	4200 ₅₀	3600 ₆₅	3250 ₈₅	4050 ₅₀	3600 ₆₅	3250 ₆₅	3700 ₆₀	3350 ₇₅	3050 ₁₀₀
400x82	40	5900 ₅₀	5650 ₆₅	5450 ₉₀	5550 ₈₀	5350 ₁₀₀	5100 ₁₁₅	5350 ₉₀	5150 ₁₀₀	4900 ₁₀₅	4900 ₁₀₅	4750 ₁₁₅	4500 ₁₂₀
	90	5700 ₈₀	5300 ₁₀₅	4650 ₁₂₅	5450 ₉₅	4850 ₁₂₀	4300 ₁₄₀	5250 ₁₀₀	4700 ₁₁₅	4200 ₁₃₅	4800 ₁₁₀	4350 ₁₃₀	3950 ₁₄₅

NOTES:

- Sizes in italics are SmartLVL 14
- D = member depth, B = member breadth, NS = not suitable.
- The above table was based on total upper floor mass of 40 kg/m², total ground floor mass of 30 kg/m², floor live load of 1.5 kPa, floor point load of 1.8 kN, wall mass of 32 kg/m², and permanent floor live load of 0.5 kPa.
- The above table was based on a wall height of 5400 mm
- End bearing lengths = 42 mm at end supports and 58 mm at internal supports for continuous members. Subscript values indicate the minimum additional bearing length where required to be greater than 42 mm at end supports and 58 mm at internal supports.
- Not all sizes of SmartLVL in this table are stocked in each state. Please check with your supplier before ordering WA only

Single span lintels in single/upper storey walls AS 4055 classification N1, N2 and N3

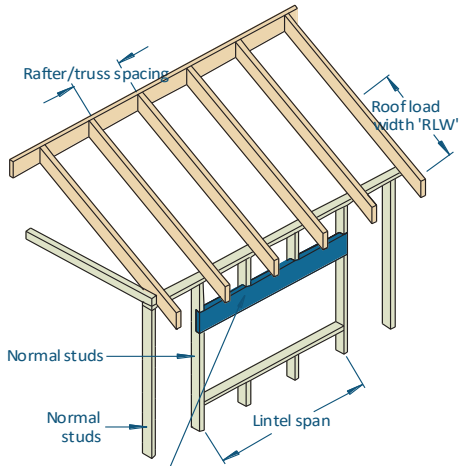

EXAMPLE:

wind speed = N3
 sheet roof - 40 kg/m²
 rafter/truss spacing = 600 mm
 lintel span = 3500 mm
 roof load width = 3900 mm
 Enter span table at 4500 roof load width column, rafter/truss spacing 600 mm, and read down to a span equal to or greater than 3500 mm

ADOPT:

SmartLVL 14 - 2/240x35

Single/Upper storey lintel

Roof load width (mm)		1500		3000		4500		6000		7500	
Rafter/Truss spacing (mm)		600	1200	600	1200	600	1200	600	1200	600	1200
Member size DxB (mm)	Roof mass (kg/m ²)	Maximum recommended Lintel span (mm)									
		Single span									
120x35	40	2450	2550	1950	1950	1700	1300	1450	NS	1300	NS
	90	1850	1850	1500	1300	1300	NS	1150	NS	NS	NS
130x35	40	2650	2700	2100	2100	1800	1550	1550	NS	1400 ₅	NS
	90	2000	2000	1600	1500	1400	1200	1250 ₅	NS	1150	NS
140x35	40	2850	2850	2250	2300	1950	1750	1650	1300	1500 ₅	NS
	90	2200	2150	1700	1650	1500	1350	1400 ₅	NS	1250 ₁₀	NS
150x35	40	3050	3000	2450	2500	2100	2000	1800	1500 ₁₀	1600 ₅	NS
	90	2350	2350	1850	1850	1600	1500 ₅	1450 ₅	NS	1400 ₁₀	NS
170x35	40	3350	3300	2750	2800	2400	2300	2050	1850 ₅	1800 ₅	1450 ₂₀
	90	2650	2700	2100	2100	1800	1800 ₅	1650 ₅	1450 ₂₅	1550 ₁₅	NS
190x35	40	3600	3600	3050	3050	2650	2600 ₁₀	2300 ₅	2200 ₁₀	2000 ₅	1650 ₁₅
	90	2950	2950	2350	2350	2050	2000 ₁₀	1850 ₅	1650 ₂₀	1700 ₁₅	1100 ₁₀
200x35	40	3750	3700	3200	3150	2800 ₅	2700 ₁₅	2450 ₁₅	2300 ₁₀	2150 ₂₀	1750 ₁₅
	90	3100	3050	2500	2500 ₅	2150 ₅	2150 ₁₀	1950 ₅	1750 ₁₅	1800 ₁₀	1400 ₁₅
240x35	40	4300	4300	3650	3600	3300 ₅	3150 ₁₀	2850 ₂₀	2750 ₃₀	2550 ₂₅	2450 ₃₅
	90	3550	3500	3000	3000 ₅	2600 ₁₀	2650 ₂₀	2350 ₂₀	2350 ₂₅	2200 ₃₅	1800 ₃₀
2/120x35	40	3050	3000	2450	2550	2150	2150	1950	1950	1800	1750
	90	2350	2400	1850	1850	1600	1500	1500	1300	1400	1200
2/130x35	40	3200	3200	2650	2700	2300	2350	2100	2100	1950	1950
	90	2550	2600	2000	2000	1750	1700	1600	1500	1500	1350
2/140x35	40	3400	3350	2850	2850	2500	2600	2250	2300	2100	2100
	90	2750	2750	2200	2150	1900	1900	1700	1650	1600	1500
2/150x35	40	3550	3550	3050	3000	2700	2700	2450	2500	2250	2250
	90	2950	2950	2350	2350	2050	2000	1850	1850	1700	1650
2/170x35	40	3900	3900	3350	3300	3000	3000	2750	2800	2550	2650
	90	3250	3200	2650	2700	2300	2300	2100	2100	1950	1950
2/190x35	40	4250	4250	3600	3600	3300	3250	3050	3050	2850	2900 ₅
	90	3500	3500	2950	2950	2600	2650	2350	2350	2200	2150
2/200x35	40	4400	4400	3750	3700	3400	3400	3200	3150	3000	3000
	90	3650	3600	3100	3050	2750	2750	2500	2500 ₅	2300	2300 ₅
2/240x35	40	5000	5000	4300	4300	3900	3900	3650	3600	3450 ₅	3400 ₅
	90	4150	4150	3550	3500	3200	3200	3000	3000 ₅	2750 ₁₀	2800 ₁₅
2/300x35	40	5900	5850	5050	5050	4600	4600	4300	4300 ₅	4050 ₁₀	4050 ₂₀
	90	4900	4900	4200	4150	3800	3750	3550 ₅	3500 ₅	3350 ₅	3300 ₁₀
130x42	40	2850	2850	2300	2300	2000	2000	1800	1750	1700	1400 ₁₀
	90	2200	2200	1750	1700	1550	1400	1400	1200	1300 ₅	NS
140x42	40	3050	3050	2450	2550	2150	2150	1950	1950	1800	1550 ₅
	90	2350	2400	1900	1900	1650	1550	1500	1350	1400 ₁₀	1100 ₅

Single span lintels in single/upper storey walls AS 4055 classification N1, N2 and N3 (Cont'd)

Roof load width (mm)		1500		3000		4500		6000		7500	
Rafter/Truss spacing (mm)		600	1200	600	1200	600	1200	600	1200	600	1200
Member size DxB (mm)	Roof mass (kg/m ²)	Maximum recommended Lintel span (mm)									
		Single span									
150x42	40	3200	3200	2650	2700	2300	2350	2100	2100 ₅	1950	1800 ₁₀
	90	2550	2600	2050	2000	1750	1700	1600	1500 ₁₀	1500 ₅	1350 ₁₀
170x42	40	3500	3500	3000	3000	2650	2700 ₅	2400	2400 ₁₀	2200 ₅	2200 ₁₅
	90	2900	2900	2300	2300	2000	2000	1800	1800 ₁₀	1700 ₅	1600 ₂₀
190x42	40	3800	3800	3250	3250	2950	2950	2700 ₁₀	2700 ₁₅	2500 ₁₀	2450 ₂₀
	90	3150	3150	2600	2650	2250	2200 ₅	2050	2000 ₁₀	1900 ₅	1850 ₂₀
200x42	40	3950	3950	3400	3350	3050	3050	2800 ₅	2850 ₁₅	2650 ₁₀	2600 ₂₀
	90	3300	3250	2700	2750	2350	2350 ₅	2150 ₁₀	2100 ₁₀	2000 ₁₀	1950 ₂₀
240x42	40	4500	4500	3850	3850	3500 ₅	3500 ₅	3300 ₅	3250 ₁₅	3100 ₁₅	3000 ₂₅
	90	3750	3750	3200	3150	2850 ₁₀	2850 ₁₅	2600 ₁₅	2600 ₂₅	2400 ₂₅	2350 ₂₅
300x42	40	5300	5300	4550	4550	4150 ₁₀	4150 ₁₅	3850 ₁₅	3850 ₂₀	3650 ₂₅	3650 ₃₀
	90	4450	4400	3750	3750	3400 ₅	3400 ₁₅	3150 ₂₀	3150 ₃₀	3000 ₃₅	3000 ₅₀
2/130x42	40	3400	3350	2850	2850	2550	2600	2300	2300	2150	2100
	90	2750	2800	2200	2200	1900	1900	1750	1700	1600	1500
2/140x42	40	3550	3550	3050	3050	2700	2750	2450	2550	2300	2300
	90	2950	2950	2350	2400	2100	2050	1900	1900	1750	1700
2/150x42	40	3750	3700	3200	3200	2900	2900	2650	2700	2450	2500
	90	3150	3100	2550	2600	2250	2200	2050	2000	1850	1850
2/170x42	40	4100	4100	3500	3500	3200	3200	3000	3000	2800	2800
	90	3450	3400	2900	2900	2550	2600	2300	2300	2150	2100
2/190x42	40	4450	4400	3800	3800	3500	3450	3250	3250	3100	3050
	90	3700	3700	3150	3150	2850	2850	2600	2650	2400	2400 ₅
2/200x42	40	4600	4600	3950	3950	3600	3600	3400	3350	3200	3200
	90	3850	3850	3300	3250	2950	2950	2700	2750	2500	2550 ₅
2/240x42	40	5200	5200	4500	4500	4150	4100	3850	3850	3650	3650
	90	4400	4400	3750	3750	3400	3400	3200	3150	3000	3000 ₅
2/300x42	40	6050	6050	5300	5300	4850	4850	4550	4550	4300	4300 ₅
	90	5150	5200	4450	4400	4050	4000	3750	3750	3550 ₁₀	3550 ₅
2/360x42	40	6850	6850	6050	6000	5550	5550	5200	5200	4950 ₁₀	4900 ₁₀
	90	5900	5850	5050	5050	4600	4600	4300 ₅	4300 ₁₀	4100 ₁₀	4050 ₁₀
2/400x42	40	7400	7350	6500	6500	6000	5950	5600 ₅	5600 ₁₀	5350 ₅	5350 ₁₀
	90	6350	6350	5450	5450	5000	4950 ₅	4650 ₅	4650 ₁₀	4400 ₁₅	4400 ₂₀
130x58	40	3100	3100	2550	2600	2250	2250	2050	2000	1850	1900
	90	2450	2550	1950	1950	1700	1650	1550	1400	1450	1250
150x58	40	3450	3450	2950	2950	2600	2650	2350	2350	2200	2150
	90	2800	2850	2250	2250	1950	1950	1800	1750	1650	1550 ₅
170x58	40	3800	3750	3250	3200	2900	2900	2650	2700	2450	2500 ₅
	90	3150	3100	2550	2650	2250	2200	2050	2000	1900	1850 ₅
200x58	40	4250	4250	3650	3600	3300	3300	3100	3100	2900	2900 ₁₀
	90	3550	3500	3000	3000	2650	2700	2400	2400 ₁₀	2250 ₅	2200 ₁₀
240x58	40	4850	4850	4150	4150	3800	3750	3550	3500 ₅	3350 ₁₀	3350 ₁₀
	90	4050	4050	3450	3400	3100	3100	2900 ₅	2900 ₁₅	2700 ₁₀	2700 ₂₀
300x58	40	5650	5650	4900	4900	4450	4450	4150 ₁₀	4150 ₁₅	3950 ₁₀	3950 ₁₅
	90	4750	4750	4050	4050	3700 ₅	3650 ₅	3450 ₁₅	3400 ₁₀	3250 ₁₀	3250 ₂₀
360x58	40	6450	6400	5600	5550	5100	5100 ₅	4800 ₁₅	4750 ₁₀	4550 ₁₅	4500 ₂₅
	90	5450	5450	4650	4600	4200 ₁₀	4200 ₁₅	3950 ₁₅	3900 ₁₅	3750 ₃₀	3700 ₂₅
400x58	40	6900	6900	6050	6000	5500 ₁₀	5500 ₁₀	5150 ₁₅	5150 ₁₅	4900 ₂₅	4900 ₃₀
	90	5850	5850	5000	5000 ₅	4550 ₅	4550 ₁₅	4250 ₂₅	4250 ₃₀	4050 ₃₀	4000 ₂₅
240x75	40	5100	5100	4350	4350	3950	3950	3700	3650	3500	3500
	90	4250	4250	3600	3550	3250	3250	3050	3000	2850	2850 ₅
300x75	40	5950	5950	5150	5150	4700	4650	4350	4350	4150	4150
	90	5000	5000	4250	4250	3850	3800	3600	3550	3400	3350
400x75	40	7300	7300	6300	6300	5800	5750	5400	5400	5150	5100 ₅
	90	6150	6150	5250	5250	4800	4750	4450	4450 ₅	4200 ₁₀	4200 ₂₀
525x75	40	8800	8800	7700	7650	7050	7050	6600	6600	6250 ₁₀	6250 ₅
	90	7500	7500	6400	6400	5850	5800 ₅	5450 ₁₀	5450 ₁₅	5150 ₂₀	5150 ₂₅
300x82	40	6150	6150	5300	5300	4850	4850	4550	4500	4300	4300
	90	5200	5200	4400	4400	4000	4000	3750	3700	3550	3500
400x82	40	7500	7500	6550	6550	6000	5950	5600	5600	5300	5300
	90	6350	6350	5450	5450	4950	4950	4650	4600 ₅	4400 ₁₀	4400 ₁₅

NOTES:

- Sizes in italics are SmartLVL 14
- D = member depth, B = member breadth, NS = not suitable.
- Minimum bearing length = 35 mm at end supports. Subscript values indicate the minimum additional bearing length where required to be greater than 35 mm.
- Restraint value for slenderness calculations is 600 mm.
- Not all sizes of SmartLVL in this table are stocked in each state. Please check with your supplier before ordering WA only

Single span lintels in single/upper storey walls AS 4055 classification C1, C2 and C3

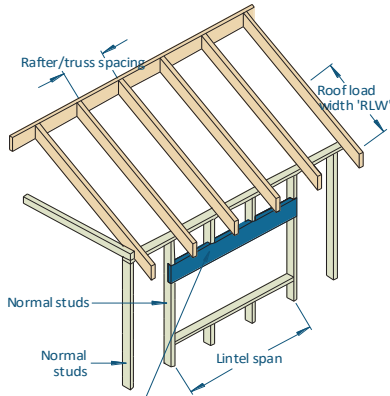

Single/Upper storey lintel

EXAMPLE:

wind speed = C3
 sheet roof - 40 kg/m²
 rafter/truss spacing = 600 mm
 lintel span = 3400 mm
 roof load width = 3900 mm
 Enter span table at 4500 roof load width column, rafter/truss spacing 600 mm, and read down to a span equal to or greater than 3400 mm

ADOPT:

SmartLVL 14 - 2/240x35
 (additional 5 mm bearing required)

Roof load width (mm)		1500		3000		4500		6000		7500	
Rafter/Truss spacing (mm)		600	1200	600	1200	600	1200	600	1200	600	1200
Member size DxB (mm)	Roof mass (kg/m ²)	Maximum recommended Lintel span (mm)									
		Single span									
120x35	40	2100	1900	1450	NS	NS	NS	NS	NS	NS	NS
	90	1850	1850	1450	NS	NS	NS	NS	NS	NS	NS
130x35	40	2300	2150	1550	NS	1250 ₅	NS	NS	NS	NS	NS
	90	2000	2000	1550	NS	1300 ₁₀	NS	NS	NS	NS	NS
140x35	40	2450	2300	1650	1200	1350 ₅	NS	NS	NS	NS	NS
	90	2200	2150	1650	1300	1400 ₁₀	NS	NS	NS	NS	NS
150x35	40	2600	2500	1750	1400 ₅	1450 ₁₀	NS	NS	NS	NS	NS
	90	2350	2350	1800	1500 ₁₀	1450 ₁₅	NS	NS	NS	NS	NS
170x35	40	2900	2800	2000	1800	1600 ₅	NS	1300 ₁₅	NS	NS	NS
	90	2650	2700	2050	1850 ₁₀	1600 ₁₀	NS	1400 ₂₅	NS	NS	NS
190x35	40	3200	3050	2250	2150 ₅	1750 ₅	1100 ₅	1500 ₂₅	NS	1050 ₁₀	NS
	90	2950	2950	2300 ₅	2200 ₁₅	1800 ₁₀	1300 ₁₀	1550 ₃₀	NS	1100 ₂₀	NS
200x35	40	3350	3200	2400 ₁₀	2250 ₅	1850 ₅	1400 ₅	1600 ₂₀	NS	1100 ₁₀	NS
	90	3100	3050	2450 ₁₅	2300 ₁₅	1900 ₁₅	1500 ₃₅	1650 ₃₀	NS	1150 ₁₅	NS
240x35	40	4000	3850	2800 ₁₅	2700 ₁₅	2250 ₂₀	1800 ₂₀	1900 ₁₅	1250 ₁₅	1700 ₃₅	NS
	90	3550	3500	2850 ₂₀	2750 ₃₀	2350 ₃₀	1900 ₂₅	1900 ₂₅	1400 ₂₅	1700 ₄₅	NS
2/120x35	40	2950	2950	2250	2100	1750	1450	1500	NS	1350	NS
	90	2350	2400	1850	1850	1600	1500	1500	NS	1400 ₅	NS
2/130x35	40	3200	3150	2450	2300	1900	1650	1650	NS	1450	NS
	90	2550	2600	2000	2000	1750	1700	1600	NS	1500 ₅	NS
2/140x35	40	3400	3350	2600	2550	2100	1900	1750	1200	1550	NS
	90	2750	2750	2200	2150	1900	1900	1700	1400 ₁₀	1600 ₅	NS
2/150x35	40	3550	3550	2750	2700	2250	2100	1900	1450 ₅	1650	NS
	90	2950	2950	2350	2350	2050	2000	1850	1550 ₁₀	1650 ₅	NS
2/170x35	40	3900	3900	3100	2950	2550	2400 ₅	2150	2050 ₅	1900	1300
	90	3250	3200	2650	2700	2300	2300 ₅	2100 ₁₀	2100 ₁₀	1950 ₅	1450 ₂₀
2/190x35	40	4250	4250	3450	3250	2800	2700 ₁₀	2450 ₁₀	2300 ₁₀	2150 ₁₀	1600 ₁₀
	90	3500	3500	2950	2950	2600 ₅	2650 ₁₀	2350 ₅	2350 ₁₅	2200 ₂₀	1650 ₂₀
2/200x35	40	4400	4400	3650	3450	2900	2800 ₅	2550 ₁₀	2400 ₁₅	2250 ₁₀	1700 ₁₀
	90	3650	3600	3100	3050	2750 ₅	2750 ₁₅	2500 ₁₅	2500 ₂₅	2300 ₁₅	1750 ₁₅
2/240x35	40	5000	5000	4250	4150	3450 ₅	3300 ₅	2950 ₁₀	2850 ₂₀	2650 ₂₀	2600 ₃₀
	90	4150	4150	3550	3500	3200 ₅	3200 ₁₀	3000 ₁₅	2900 ₃₀	2700 ₂₅	2650 ₄₀
2/300x35	40	5900	5850	5050 ₅	5050 ₁₀	4250 ₁₅	4150 ₂₀	3700 ₂₅	3500 ₂₀	3250 ₂₀	3100 ₃₀
	90	4900	4900	4200 ₅	4150 ₁₀	3800 ₁₅	3750 ₁₅	3550 ₃₀	3500 ₃₀	3350 ₃₀	3200 ₄₀
130x42	40	2650	2600	1800	1500	1450	NS	NS	NS	NS	NS
	90	2200	2200	1750	1650	1500	NS	1350 ₁₀	NS	NS	NS
140x42	40	2800	2750	1950	1700	1550	NS	1350	NS	NS	NS
	90	2350	2400	1900	1900	1600	NS	1400 ₁₅	NS	NS	NS

Single span lintels in single/upper storey walls AS 4055 classification C1, C2 and C3 (Cont'd)

Roof load width (mm)		1500		3000		4500		6000		7500	
Rafters/Truss spacing (mm)		600	1200	600	1200	600	1200	600	1200	600	1200
Member size DxB (mm)	Roof mass (kg/m ²)	Maximum recommended Lintel span (mm)									
		Single span									
150x42	40	3000	2900	2100	1950	1650	NS	1450 ₁₀	NS	NS	NS
	90	2550	2600	2050	2000	1750	1100 ₅	1500 ₁₅	NS	1000 ₅	NS
170x42	40	3400	3250	2400	2250	1900	1450 ₁₀	1600 ₅	NS	1100	NS
	90	2900	2900	2300	2300 ₅	2000 ₅	1550 ₁₅	1700 ₁₀	NS	1500 ₃₀	NS
190x42	40	3750	3600	2650	2550	2100 ₁₀	1650 ₅	1750 ₅	NS	1600 ₃₀	NS
	90	3150	3150	2600	2650 ₁₀	2250 ₁₅	2150 ₂₀	1900 ₁₅	1200 ₁₀	1650 ₂₅	NS
200x42	40	3950	3800	2750	2700	2250 ₅	1750 ₅	1800 ₅	1100 ₅	1650 ₁₅	NS
	90	3300	3250	2700 ₁₀	2750 ₁₅	2350 ₁₀	2250 ₂₀	2000 ₁₅	1500 ₄₀	1750 ₃₅	NS
240x42	40	4500	4500	3250	3100 ₅	2650 ₁₀	2550 ₂₀	2300 ₂₀	1700 ₂₅	1900 ₁₅	1200 ₁₀
	90	3750	3750	3200 ₅	3150 ₁₀	2750 ₃₀	2700 ₃₀	2450 ₃₅	1850 ₃₀	2100 ₃₀	1550 ₂₅
300x42	40	5300	5300	4000 ₅	3850 ₁₀	3250 ₁₅	3100 ₃₅	2800 ₂₅	2750 ₃₅	2550 ₃₅	1850 ₃₅
	90	4450	4400	3750 ₁₅	3750 ₁₅	3400 ₂₅	3250 ₃₅	2950 ₅₀	2850 ₅₀	2650 ₅₀	2000 ₄₅
2/130x42	40	3400	3350	2700	2750	2300	2150	1950	1500	1700	NS
	90	2750	2800	2200	2200	1900	1900	1750	1700	1600	1150
2/140x42	40	3550	3550	2900	2900	2450	2350	2100	1950	1850	1150
	90	2950	2950	2350	2400	2100	2050	1900	1900	1750	1450 ₁₀
2/150x42	40	3750	3700	3100	3100	2600	2600	2250	2150	2000	1450
	90	3150	3100	2550	2600	2250	2200	2050	2000	1850	1600 ₅
2/170x42	40	4100	4100	3500	3450	2900	2850	2550	2450	2300	1700
	90	3450	3400	2900	2900	2550	2600	2300	2300 ₅	2150 ₅	2100 ₁₀
2/190x42	40	4450	4400	3800	3800	3250	3100	2800	2750 ₁₀	2550 ₅	2400 ₁₀
	90	3700	3700	3150	3150	2850	2850	2600	2650 ₁₀	2400 ₁₀	2400 ₂₀
2/200x42	40	4600	4600	3950	3950	3450	3250	2950	2850 ₅	2650 ₅	2550 ₁₀
	90	3850	3850	3300	3250	2950	2950	2700 ₁₀	2750 ₁₅	2500 ₁₀	2550 ₂₀
2/240x42	40	5200	5200	4500	4500	4050	3900	3500 ₅	3350 ₅	3100 ₅	3000 ₁₅
	90	4400	4400	3750	3750	3400 ₅	3400 ₅	3200 ₅	3150 ₁₀	3000 ₁₅	3000 ₂₅
2/300x42	40	6050	6050	5300	5300	4850 ₅	4850 ₁₀	4300 ₁₅	4200 ₂₀	3850 ₁₅	3650 ₂₀
	90	5150	5200	4450	4400	4050 ₅	4000 ₅	3750 ₁₅	3750 ₁₅	3550 ₃₀	3550 ₂₅
2/360x42	40	6850	6850	6050	6000	5550 ₁₀	5550 ₁₅	5000 ₂₀	4950 ₂₅	4450 ₂₅	4400 ₃₅
	90	5900	5850	5050	5050	4600 ₅	4600 ₁₅	4300 ₂₅	4300 ₃₀	4100 ₂₅	4050 ₃₀
2/400x42	40	7400	7350	6500	6500	6000 ₁₅	5950 ₁₅	5450 ₃₀	5350 ₂₅	4900 ₃₅	4850 ₄₀
	90	6350	6350	5450 ₅	5450 ₁₀	5000 ₁₅	4950 ₂₀	4650 ₂₀	4650 ₃₀	4400 ₄₀	4400 ₅₀
130x58	40	3000	3000	2200	2050	1700	1350	1500	NS	1350	NS
	90	2450	2550	1950	1950	1700	1500	1550	NS	1400 ₁₀	NS
150x58	40	3450	3400	2500	2400	2000	1800	1700	NS	1500 ₅	NS
	90	2800	2850	2250	2250	1950	1950 ₅	1800	1300 ₅	1600 ₁₀	NS
170x58	40	3800	3750	2800	2700	2300	2150	1900	1500 ₁₀	1700	NS
	90	3150	3100	2550	2650	2250	2200 ₅	2050 ₅	1600 ₁₀	1800 ₁₀	1000 ₅
200x58	40	4250	4250	3250	3100	2650	2600 ₅	2300 ₅	2200 ₁₀	2000 ₅	1500 ₂₀
	90	3550	3500	3000	3000	2650 ₅	2700 ₁₀	2400 ₁₅	2300 ₂₀	2100 ₂₅	1600 ₂₅
240x58	40	4850	4850	3850	3700	3100	3000 ₁₀	2700 ₁₀	2650 ₁₅	2450 ₂₀	1850 ₁₅
	90	4050	4050	3450	3400	3100 ₁₀	3100 ₁₅	2800 ₂₅	2750 ₂₅	2550 ₃₀	2450 ₄₀
300x58	40	5650	5650	4750 ₅	4700 ₅	3850 ₁₀	3700 ₁₀	3300 ₁₅	3150 ₂₅	2950 ₃₀	2850 ₃₀
	90	4750	4750	4050 ₁₀	4050 ₅	3700 ₂₀	3650 ₂₀	3450 ₄₀	3300 ₃₀	3100 ₄₀	2950 ₅₅
360x58	40	6450	6400	5500 ₁₀	5450 ₁₅	4450 ₁₅	4400 ₃₅	3850 ₂₅	3700 ₂₅	3450 ₂₅	3300 ₄₀
	90	5450	5450	4650 ₅	4600 ₁₀	4200 ₃₀	4200 ₄₀	3950 ₃₅	3900 ₄₀	3650 ₅₅	3450 ₅₀
400x58	40	6900	6900	6050 ₁₅	5900 ₁₅	4900 ₂₅	4900 ₃₀	4200 ₄₀	4100 ₃₀	3750 ₄₀	3600 ₃₅
	90	5850	5850	5000 ₁₅	5000 ₁₅	4550 ₂₅	4550 ₃₅	4250 ₅₀	4250 ₆₅	3950 ₅₅	3800 ₅₀
240x75	40	5100	5100	3950	3800	3200	3050	2750 ₅	2700 ₁₅	2500 ₁₅	2350 ₁₅
	90	4250	4250	3600	3550	3250	3100 ₅	2800 ₁₅	2750 ₂₀	2550 ₂₅	2400 ₃₅
300x75	40	5950	5950	4850	4800 ₅	3950 ₁₀	3800 ₅	3400 ₅	3250 ₁₅	3000 ₂₀	2900 ₃₀
	90	5000	5000	4250	4250 ₅	3850 ₁₅	3800 ₁₅	3500 ₂₅	3300 ₂₀	3100 ₂₅	2950 ₄₀
400x75	40	7300	7300	6150 ₁₀	6050 ₅	5000 ₂₀	5000 ₂₅	4300 ₂₅	4250 ₃₅	3850 ₃₅	3700 ₂₅
	90	6150	6150	5250 ₁₀	5250 ₁₀	4800 ₂₅	4750 ₂₀	4400 ₃₅	4300 ₄₅	3900 ₄₅	3800 ₆₅
525x75	40	8800	8800	7700 ₂₀	7650 ₂₀	6300 ₃₀	6200 ₂₅	5400 ₃₅	5350 ₄₅	4850 ₅₅	4800 ₆₅
	90	7500	7500	6400 ₁₅	6400 ₁₅	5850 ₃₅	5800 ₄₀	5450 ₅₀	5450 ₅₅	4950 ₆₅	4900 ₈₀
300x82	40	6150	6150	5300	5300	4550	4500	3900 ₅	3800 ₅	3500 ₁₅	3350 ₁₀
	90	5200	5200	4400	4400	4000	4000	3750	3700	3550 ₁₀	3500 ₅
400x82	40	7500	7500	6550	6550	5950 ₅	5800 ₁₀	5100 ₁₅	5100 ₂₀	4550 ₂₀	4550 ₂₅
	90	6350	6350	5450	5450	4950	4950	4650 ₅	4600 ₁₀	4400 ₁₅	4400 ₂₀

NOTES:

- Sizes in italics are SmartLVL 14
- D = member depth, B = member breadth, NS = not suitable.
- Minimum bearing length = 35 mm at end supports. Subscript values indicate the minimum additional bearing length where required to be greater than 35 mm.
- Restraint value for slenderness calculations is 600 mm.
- Not all sizes of SmartLVL in this table are stocked in each state. Please check with your supplier before ordering WA only

Single span lintels in lower storey walls AS 4055 classification N1, N2, N3 & C1

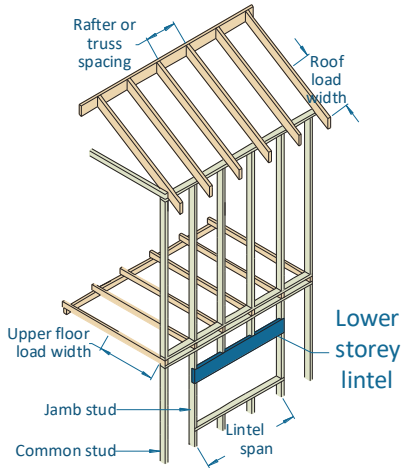

EXAMPLE:

wind speed = N3
 sheet roof - 40 kg/m²
 rafter/truss spacing = 600 mm
 lintel span = 3500 mm
 roof load width = 3900 mm
 floor load width = 1200 mm
 Enter span table at 4500 roof load width column, floor load width 1200 mm, and read down to a span equal to or greater than 3500 mm

ADOPT:

SmartLVL 14 - 2/300x35

Roof load width (mm)		1500			3000			4500			6000		
floor load width (mm)		1200	2400	3600	1200	2400	3600	1200	2400	3600	1200	2400	3600
Member size DxB (mm)	Roof mass (kg/m ²)	Maximum recommended Lintel span (mm)											
		Single span											
120x35	40	1350	1200	1100	1300	1150	1050	1250	1100	1050	1200	1100	1000
	90	1250	1150	1050	1150	1050	1000	1100	1000	NS	1000	NS	NS
130x35	40	1450	1300	1200	1400	1250	1150	1350	1200	1150	1300	1200	1100
	90	1400	1250	1150	1250	1150	1100	1150	1100	1050	1100	1050	1000
140x35	40	1600	1400	1300	1500	1350	1250	1450	1300	1200	1400	1250	1200
	90	1500	1350	1250	1350	1250	1150	1250	1200	1100	1200	1150	1050
150x35	40	1700	1500	1400	1600	1450	1350	1550	1400	1300	1500	1350	1250
	90	1600	1450	1350	1450	1350	1250	1350	1250	1200	1300	1200	1150
170x35	40	1950	1700	1550	1850	1650	1500	1750	1600	1500	1700	1550	1450
	90	1800	1650	1500	1650	1550	1450	1550	1450	1350 ₅	1450	1350	1300 ₅
190x35	40	2150	1900	1750 ₅	2050	1850	1700 ₅	1950	1800	1650 ₅	1900	1750	1600 ₅
	90	2050	1850	1700 ₅	1850	1700	1600 ₅	1700	1600	1500 ₁₀	1600 ₅	1550 ₅	1450 ₁₀
200x35	40	2300	2000	1850 ₅	2150	1950	1800 ₅	2050	1900	1750 ₅	2000	1850	1700 ₅
	90	2150	1950	1800 ₅	1950	1800	1700 ₁₀	1800	1700 ₅	1600 ₁₀	1700 ₅	1600 ₁₀	1550 ₁₀
240x35	40	2750	2450 ₅	2200 ₁₀	2600	2350 ₅	2150 ₁₅	2500	2250 ₅	2100 ₁₅	2400	2200 ₅	2050 ₁₅
	90	2550	2300 ₅	2150 ₁₅	2350	2150 ₅	2050 ₁₅	2200 ₅	2050 ₁₀	1950 ₂₀	2050 ₁₀	1950 ₁₅	1850 ₂₀
2/120x35	40	1700	1500	1400	1650	1450	1350	1550	1400	1300	1500	1400	1300
	90	1600	1450	1350	1450	1350	1250	1350	1300	1200	1300	1200	1150
2/130x35	40	1850	1650	1500	1750	1600	1450	1700	1550	1450	1600	1500	1400
	90	1750	1600	1450	1600	1450	1350	1500	1400	1300	1400	1300	1250
2/140x35	40	2000	1800	1650	1900	1700	1600	1800	1650	1550	1750	1600	1500
	90	1900	1700	1550	1700	1600	1500	1600	1500	1400	1500	1400	1350
2/150x35	40	2150	1900	1750	2050	1850	1700	1950	1800	1650	1850	1700	1600
	90	2000	1800	1700	1850	1700	1600	1700	1600	1500	1600	1550	1450
2/170x35	40	2450	2150	2000	2300	2100	1900	2200	2000	1850	2150	1950	1850
	90	2300	2050	1900	2100	1950	1800	1950	1800	1700	1850	1750	1650
2/190x35	40	2700	2400	2200	2600	2350	2150	2450	2250	2100	2400	2200	2050
	90	2550	2300	2150	2350	2150	2000	2150	2050	1900	2050	1950	1850
2/200x35	40	2850	2550	2350	2700	2450	2250	2600	2400	2200	2500	2300	2150
	90	2700	2450	2250	2450	2250	2150	2300	2150	2050	2150	2050	1950
2/240x35	40	3300	3050	2800	3200	2950	2700	3100	2850	2650	3000	2750	2600
	90	3150	2900	2700	2950	2750	2550	2750	2600	2450	2600	2450	2350
2/300x35	40	3900	3600	3350	3750	3500	3300	3650	3400	3250 ₅	3550	3350	3150 ₅
	90	3750	3450	3250 ₅	3500	3300	3150 ₅	3300	3150	3050 ₁₀	3200	3050 ₅	2900 ₁₀
130x42	40	1900	1650	1500	1750	1550	1400	1650	1500	1350	1550	1450	1300
	90	1750	1550	1400	1500	1400	1300	1400	1300	1200	1300	1200	1150
140x42	40	2050	1750	1600	1900	1700	1550	1750	1600	1450	1700	1550	1450
	90	1850	1650	1500	1650	1500	1400	1500	1400	1300	1400	1300	1250

Single span lintels in lower storey walls AS 4055 classification N1, N2, N3 & C1 (Cont'd)

Roof load width (mm)		1500			3000			4500			6000		
floor load width (mm)		1200	2400	3600	1200	2400	3600	1200	2400	3600	1200	2400	3600
Member size DxB (mm)	Roof mass (kg/m ²)	Maximum recommended Lintel span (mm)											
		Single span											
150x42	40	2200	1900	1700	2050	1800	1650	1900	1700	1600	1800	1650	1550
	90	2000	1800	1600	1750	1600	1500	1600	1500	1400	1500	1400	1350 ₅
170x42	40	2500	2150	1950	2300	2050	1850	2150	1950	1800	2050	1850	1750 ₅
	90	2250	2000	1850	2000	1850	1700 ₅	1800	1700	1600 ₅	1700	1600 ₅	1550 ₁₀
190x42	40	2800	2400	2150 ₅	2600	2300	2100 ₅	2400	2200	2000 ₅	2300	2100	1950 ₅
	90	2550	2250	2050 ₅	2250	2050	1900 ₁₀	2050	1900 ₅	1800 ₁₀	1900 ₅	1800 ₁₀	1700 ₁₅
200x42	40	2950	2550	2300 ₅	2700	2400	2200 ₁₀	2550	2300	2100 ₁₀	2400	2200	2050 ₁₀
	90	2650	2400	2150 ₁₀	2350	2150	2000 ₁₀	2150 ₅	2000 ₁₀	1900 ₁₅	2000 ₁₀	1900 ₁₅	1800 ₁₅
240x42	40	3400	3050 ₅	2750 ₁₅	3200	2900 ₅	2650 ₁₅	3050	2750 ₅	2550 ₁₅	2900	2650 ₁₀	2450 ₂₀
	90	3150	2850 ₅	2600 ₁₅	2800 ₅	2600 ₁₀	2400 ₂₀	2550 ₁₀	2400 ₁₅	2300 ₂₀	2400 ₁₅	2250 ₂₀	2150 ₂₅
300x42	40	4000	3600 ₁₀	3300 ₂₅	3750	3450 ₁₅	3200 ₂₅	3600 ₅	3300 ₁₅	3100 ₃₀	3450 ₁₀	3200 ₁₅	3050 ₃₀
	90	3700	3400 ₁₅	3200 ₂₅	3400 ₁₀	3200 ₂₀	3000 ₃₀	3150 ₂₀	3000 ₃₀	2850 ₃₅	3000 ₃₀	2850 ₃₅	2700 ₄₅
2/130x42	40	2400	2050	1850	2200	1950	1800	2050	1850	1700	1950	1800	1650
	90	2150	1950	1750	1900	1750	1650	1750	1650	1550	1650	1550	1450
2/140x42	40	2600	2250	2000	2400	2100	1950	2250	2000	1850	2100	1950	1800
	90	2350	2100	1900	2050	1900	1750	1900	1750	1650	1750	1650	1600
2/150x42	40	2750	2400	2150	2550	2250	2050	2400	2150	2000	2250	2050	1950
	90	2500	2250	2050	2200	2050	1900	2000	1900	1800	1900	1800	1700
2/170x42	40	3100	2700	2450	2900	2550	2350	2700	2450	2250	2550	2350	2200
	90	2850	2550	2300	2500	2300	2150	2300	2150	2050	2150	2000	1950
2/190x42	40	3350	3000	2700	3150	2850	2600	3000	2750	2500	2850	2650	2450
	90	3100	2850	2600	2800	2600	2400	2550	2400	2250	2400	2250	2150
2/200x42	40	3500	3150	2850	3300	3000	2750	3150	2900	2650	3000	2750	2550
	90	3250	3000	2750	2950	2700	2550	2700	2550	2400	2500	2400	2250
2/240x42	40	4000	3600	3300	3750	3450	3200	3600	3350	3150	3450	3250	3050
	90	3700	3400	3200	3400	3200	3050	3150	3000	2850	3000	2850	2700 ₅
2/300x42	40	4700	4200	3900	4400	4050	3800 ₅	4200	3950	3700 ₅	4050	3800	3600 ₅
	90	4350	4000	3750 ₅	4000	3750	3550 ₅	3750	3550 ₅	3400 ₁₀	3550 ₅	3400 ₁₀	3300 ₁₅
2/360x42	40	5350	4800	4450 ₅	5050	4650	4350 ₁₀	4800	4500	4250 ₁₀	4650	4350	4150 ₁₀
	90	5000	4600	4300 ₁₀	4550	4300 ₅	4100 ₁₀	4300 ₅	4100 ₁₀	3900 ₁₅	4050 ₁₀	3900 ₁₅	3750 ₂₀
2/400x42	40	5750	5200	4850 ₁₀	5450	5000	4700 ₁₀	5200	4850 ₅	4600 ₁₅	5000	4700 ₅	4450 ₁₅
	90	5400	4950	4650 ₁₀	4950	4650 ₅	4400 ₁₅	4600 ₅	4400 ₁₅	4250 ₂₀	4400 ₁₅	4200 ₂₀	4100 ₂₅
130x58	40	2100	1850	1650	1950	1750	1600	1850	1650	1500	1750	1600	1450
	90	1900	1700	1550	1700	1550	1450	1550	1450	1350	1450	1350	1300
150x58	40	2450	2100	1900	2250	2000	1850	2100	1900	1750	2000	1850	1700
	90	2200	2000	1800	1950	1800	1700	1800	1650	1600	1650	1550	1500
170x58	40	2750	2400	2150	2550	2250	2050	2400	2150	2000	2250	2100	1950
	90	2500	2250	2050	2200	2050	1900	2000	1900	1800	1900	1800	1700
200x58	40	3200	2800	2550	3000	2650	2450	2800	2550	2350	2650	2450	2300
	90	2950	2650	2400	2600	2400	2250	2400	2250	2100 ₅	2200	2100 ₅	2000 ₁₀
240x58	40	3650	3300	3050 ₅	3450	3150	2900 ₅	3300	3050	2800 ₅	3150	2950	2750 ₁₀
	90	3400	3100	2900 ₅	3100	2900	2700 ₁₀	2850	2700 ₅	2550 ₁₀	2650 ₅	2550 ₁₀	2400 ₁₅
300x58	40	4300	3850	3600 ₁₀	4050	3700 ₅	3450 ₁₅	3850	3600 ₅	3400 ₁₅	3700	3500 ₅	3300 ₁₅
	90	4000	3700 ₅	3450 ₁₅	3650	3450 ₁₀	3250 ₁₅	3400 ₁₀	3250 ₁₅	3100 ₂₀	3250 ₁₅	3100 ₂₀	3000 ₃₀
360x58	40	4900	4400 ₅	4100 ₂₀	4650	4250 ₁₀	4000 ₂₀	4400	4100 ₁₀	3850 ₂₀	4250 ₅	4000 ₁₀	3800 ₂₅
	90	4600	4200 ₁₀	3950 ₂₀	4200 ₅	3950 ₁₅	3750 ₂₅	3900 ₁₅	3750 ₂₅	3600 ₃₀	3700 ₂₅	3550 ₃₀	3450 ₃₅
400x58	40	5300	4800 ₁₀	4450 ₂₅	5000	4600 ₁₀	4300 ₂₅	4800 ₅	4450 ₁₅	4200 ₂₅	4600 ₁₀	4300 ₁₅	4100 ₃₀
	90	4950	4550 ₁₀	4250 ₂₅	4500 ₁₀	4250 ₂₀	4050 ₃₀	4250 ₂₀	4050 ₂₅	3850 ₃₅	4000 ₃₀	3850 ₃₅	3700 ₄₅
240x75	40	<i>3350</i>	<i>3100</i>	<i>2850</i>	<i>3250</i>	<i>3000</i>	<i>2800</i>	<i>3150</i>	<i>2900</i>	<i>2700</i>	<i>3050</i>	<i>2850</i>	<i>2650</i>
	90	<i>3200</i>	<i>3000</i>	<i>2750</i>	<i>3000</i>	<i>2800</i>	<i>2600</i>	<i>2800</i>	<i>2650</i>	<i>2500</i>	<i>2650</i>	<i>2500</i>	<i>2400</i>
300x75	40	<i>4000</i>	<i>3650</i>	<i>3400</i>	<i>3850</i>	<i>3550</i>	<i>3350</i>	<i>3700</i>	<i>3450</i>	<i>3300</i>	<i>3600</i>	<i>3400</i>	<i>3200₅</i>
	90	<i>3800</i>	<i>3550</i>	<i>3350</i>	<i>3550</i>	<i>3350</i>	<i>3200₅</i>	<i>3400</i>	<i>3200</i>	<i>3100₅</i>	<i>3250</i>	<i>3100₅</i>	<i>3000₁₀</i>
400x75	40	<i>4950</i>	<i>4500</i>	<i>4250₅</i>	<i>4750</i>	<i>4400</i>	<i>4150₁₀</i>	<i>4600</i>	<i>4300</i>	<i>4050₁₀</i>	<i>4450</i>	<i>4200₅</i>	<i>4000₁₀</i>
	90	<i>4700</i>	<i>4400</i>	<i>4150₁₀</i>	<i>4400</i>	<i>4150₅</i>	<i>3950₁₀</i>	<i>4200₅</i>	<i>4000₁₀</i>	<i>3800₁₅</i>	<i>4000₁₀</i>	<i>3850₁₅</i>	<i>3700₂₀</i>
525x75	40	<i>6000</i>	<i>5550₅</i>	<i>5200₁₅</i>	<i>5800</i>	<i>5400₁₀</i>	<i>5100₂₀</i>	<i>5600</i>	<i>5250₁₀</i>	<i>5000₂₀</i>	<i>5450₅</i>	<i>5150₁₀</i>	<i>4900₂₀</i>
	90	<i>5750</i>	<i>5350₁₀</i>	<i>5050₂₀</i>	<i>5400₅</i>	<i>5100₁₀</i>	<i>4850₂₀</i>	<i>5100₁₀</i>	<i>4900₁₅</i>	<i>4700₂₅</i>	<i>4900₁₅</i>	<i>4700₂₅</i>	<i>4550₃₀</i>
300x82	40	4250	3900	3700	4050	3800	3600	3900	3700	3500	3800	3600	3450
	90	4000	3800	3600	3750	3550	3400	3550	3400	3300 ₅	3400 ₅	3300 ₅	3200 ₁₀
400x82	40	5250	4850	4550 ₅	5000	4700	4450 ₅	4850	4600	4350 ₁₀	4700	4450 ₅	4300 ₁₀
	90	5000	4700	4450 ₅	4650	4400 ₅	4250 ₁₀	4400 ₅	4200 ₁₀	4050 ₁₅	4200 ₁₀	4050 ₁₅	3950 ₂₀

NOTES:

- Sizes in italics are SmartLVL 14
- D = member depth, B = member breadth, NS = not suitable.
- Minimum bearing length = 35 mm at end supports. Subscript values indicate the minimum additional bearing length where required to be greater than 35 mm.
- Restraint value for slenderness calculations is 600 mm.
- Not all sizes of SmartLVL in this table are stocked in each state. Please check with your supplier before ordering WA only

Single/continuous span roof rafter - with ceiling attached AS 4055 classification N1, N2 and N3

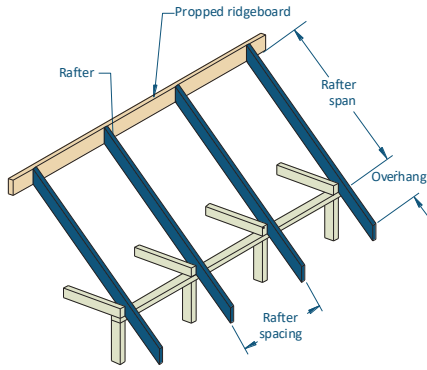

Maximum Birds-mouth = 30% of rafter dept

EXAMPLE:

wind speed = N3
sheet roof - 40 kg/m²
rafter/truss spacing = 600 mm
rafter span = 5800 mm (single span)
Enter span table at rafter spacing of 600 mm, and read down to a span equal to or greater than 5800 mm

ADOPT:

SmartLVL 14 - 240x35

Rafter spacing (mm)		450		600		900		1200		450		600		900		1200	
Member size D x B (mm)	Roof mass (kg/m ²)	span	O/H	span	O/H	span	O/H	span	O/H	span	O/H	span	O/H	span	O/H	span	O/H
		Maximum recommended single span (mm)								Maximum recommended continuous span (mm)							
90x35	30	2200	550	2150	550	2100	525	2100	500	2700	550	2700	550	2700	525	2700	500
	40	2200	550	2150	550	2100	525	2000	500	2700	550	2700	550	2700	525	2700	500
	75	2200	550	2000	525	1750	475	1600	450	2700	550	2700	525	2400	475	2200	450
	90	2100	525	1900	500	1650	450	1500	425	2700	525	2600	500	2250	450	2050	425
120x35	30	3300	750	3250	725	3150	675	2900	625	4150	750	4150	725	4150	675	3750	625
	40	3300	750	3250	725	2900	675	2650	625	4150	750	4150	725	3900	675	3600	625
	75	2950	675	2700	650	2350	575	2150	550	4000	675	3650	650	3200	575	2900	550
	90	2800	650	2550	600	2200	550	2000	525	3750	650	3450	600	3000	550	2750	525
130x35	30	3700	800	3650	775	3400	700	3100	650	4650	800	4650	775	4600	700	4050	650
	40	3700	800	3550	775	3100	700	2850	650	4650	800	4650	775	4250	700	3850	650
	75	3200	725	2900	675	2550	625	2350	575	4300	725	3950	675	3450	625	3150	575
	90	3000	700	2750	650	2400	600	2200	550	4100	700	3750	650	3250	600	3000	550
140x35	30	4100	850	4050	825	3650	750	3350	700	5150	850	5150	825	4950	750	4350	700
	40	4100	850	3800	825	3350	750	3050	700	5150	850	5150	825	4550	750	4150	700
	75	3400	775	3150	725	2750	650	2500	600	4650	775	4250	725	3750	650	3400	600
	90	3250	725	2950	675	2600	625	2350	575	4400	725	4000	675	3500	625	3200	575
150x35	30	4550	925	4400	875	3900	775	3600	725	5500	925	5500	875	5300	775	4650	725
	40	4400	925	4050	875	3600	775	3300	725	5500	925	5500	875	4850	775	4450	725
	75	3650	800	3350	750	2950	675	2700	625	4950	800	4550	750	4000	675	3650	625
	90	3450	775	3150	725	2800	650	2550	600	4700	775	4300	725	3750	650	3450	600
170x35	30	5300	1025	4950	950	4400	875	4050	800	6250	1025	6250	950	6000	875	5250	800
	40	4950	1000	4550	950	4050	875	3700	800	6250	1000	6150	950	5500	875	5050	800
	75	4150	875	3800	825	3350	750	3050	700	5600	875	5150	825	4500	750	4100	700
	90	3900	850	3550	800	3150	725	2850	675	5300	850	4850	800	4250	725	3900	675
190x35	30	5900	1125	5500	1050	4900	950	4500	875	7000	1125	7000	1050	6500	950	5850	875
	40	5500	1100	5100	1025	4500	950	4150	875	7000	1100	6650	1025	6100	950	5600	875
	75	4600	950	4200	900	3700	800	3400	750	6200	950	5700	900	5050	800	4600	750
	90	4350	925	4000	850	3500	775	3200	725	5900	925	5400	850	4750	775	4350	725
200x35	30	6150	1150	5800	1075	5150	975	4750	900	7350	1150	7350	1075	6750	975	6150	900
	40	5800	1125	5350	1075	4750	975	4350	900	7350	1125	6900	1075	6300	975	5900	900
	75	4850	1000	4450	925	3900	850	3550	800	6400	1000	6000	925	5300	850	4850	800
	90	4600	950	4200	875	3700	800	3350	750	6150	950	5700	875	5000	800	4550	750
240x35	30	7000	1325	6650	1250	6100	1125	5650	1050	8800	1325	8350	1250	7700	1125	7200	1050
	40	6650	1275	6250	1225	5650	1125	5200	1050	8350	1275	7850	1225	7200	1125	6750	1050
	75	5750	1125	5300	1050	4650	975	4250	900	7300	1125	6850	1050	6250	975	5800	900
	90	5450	1075	5000	1025	4400	925	4050	850	7050	1075	6600	1025	6000	925	5450	850
90x42	30	2500	1000	2400	900	2400	850	2300	750	3100	1000	3100	900	3100	850	3100	750
	40	2500	1000	2400	900	2300	850	2100	800	3100	1000	3100	900	3100	850	2900	800
	75	2400	1000	2200	900	1900	800	1700	750	3100	1000	3000	900	2600	800	2400	750
	90	2300	1000	2100	900	1800	800	1600	750	3100	1000	2800	900	2500	800	2200	750
120x42	30	3800	1300	3700	1200	3400	1100	3100	950	4700	1300	4700	1200	4600	1100	4200	950
	40	3800	1300	3500	1200	3100	1100	2800	1000	4700	1300	4700	1200	4200	1100	3900	1000
	75	3200	1300	2900	1200	2600	1100	2300	1050	4300	1300	4000	1200	3500	1100	3200	1050
	90	3000	1300	2700	1200	2400	1100	2200	1050	4100	1300	3700	1200	3300	1100	3000	1050

Single/continuous span roof rafter - with ceiling attached AS 4055 classification N1, N2 and N3 (Cont'd)

Rafter spacing (mm)		450		600		900		1200		450		600		900		1200	
Member size D x B (mm)	Roof mass (kg/m ²)	span	O/H	span	O/H	span	O/H	span	O/H	span	O/H	span	O/H	span	O/H	span	O/H
		Maximum recommended single span (mm)								Maximum recommended continuous span (mm)							
130x42	30	4200	1400	4100	1300	3700	1200	3400	1000	5300	1400	5300	1300	5000	1200	4600	1000
	40	4100	1400	3800	1300	3400	1200	3100	1050	5300	1400	5200	1300	4600	1200	4200	1050
	75	3400	1400	3100	1300	2800	1200	2500	1150	4700	1400	4300	1300	3800	1200	3400	1150
	90	3300	1400	3000	1300	2600	1200	2400	1150	4400	1400	4100	1300	3600	1200	3200	1150
140x42	30	4700	1500	4500	1400	4000	1250	3600	1050	6000	1500	6000	1400	5400	1250	4900	1050
	40	4500	1500	4100	1400	3600	1300	3300	1100	6000	1500	5600	1400	4900	1300	4500	1100
	75	3700	1500	3400	1400	3000	1300	2700	1250	5000	1500	4600	1400	4100	1300	3700	1250
	90	3500	1500	3200	1400	2800	1300	2600	1250	4800	1500	4400	1400	3800	1300	3500	1250
150x42	30	5100	1600	4800	1500	4200	1300	3900	1150	6600	1600	6300	1500	5800	1300	5300	1150
	40	4800	1600	4400	1500	3900	1350	3600	1150	6300	1600	6000	1500	5300	1350	4800	1150
	75	4000	1600	3600	1500	3200	1400	2900	1350	5400	1600	4900	1500	4300	1400	4000	1350
	90	3700	1600	3400	1500	3000	1400	2700	1350	5100	1600	4700	1500	4100	1400	3700	1350
170x42	30	5800	1800	5300	1700	4800	1450	4400	1250	7300	1800	6900	1700	6400	1450	6000	1250
	40	5300	1800	4900	1700	4400	1500	4000	1300	6900	1800	6500	1700	6000	1500	5500	1300
	75	4500	1800	4100	1700	3600	1550	3300	1500	6100	1800	5600	1700	4900	1550	4500	1500
	90	4200	1800	3900	1700	3400	1550	3100	1500	5800	1800	5300	1700	4600	1550	4200	1500
190x42	30	6300	2000	5900	1900	5300	1600	4900	1350	7900	2000	7500	1900	6900	1600	6500	1350
	40	5900	2000	5500	1900	4900	1650	4500	1400	7500	2000	7000	1900	6500	1650	6100	1400
	75	5000	2000	4600	1900	4000	1750	3700	1650	6600	2000	6100	1900	5500	1750	5000	1650
	90	4700	2000	4300	1900	3800	1750	3500	1650	6300	2000	5900	1900	5200	1750	4700	1650
200x42	30	6500	2100	6200	1950	5600	1650	5100	1400	8200	2100	7700	1950	7100	1650	6700	1400
	40	6200	2100	5800	1950	5100	1750	4700	1500	7800	2100	7300	1950	6700	1750	6300	1500
	75	5200	2100	4800	1950	4200	1850	3900	1750	6800	2100	6400	1950	5800	1850	5300	1750
	90	5000	2100	4500	1950	4000	1850	3700	1750	6500	2100	6100	1950	5500	1850	5000	1750
240x42	30	7300	2500	7000	2350	6500	1950	6100	1650	9300	2500	8800	2350	8100	1950	7600	1650
	40	7000	2500	6600	2350	6100	2000	5600	1700	8800	2500	8300	2350	7700	2000	7200	1700
	75	6200	2500	5700	2350	5100	2200	4600	2000	7800	2500	7300	2350	6700	2200	6200	2000
	90	5900	2500	5400	2350	4800	2200	4400	2050	7400	2500	7000	2350	6400	2200	6000	2050
300x42	30	8500	3150	8100	2950	7500	2350	7100	2000	10700	3150	10200	2950	9500	2350	8900	2000
	40	8100	3150	7700	2950	7100	2450	6700	2050	10200	3150	9700	2950	9000	2450	8400	2050
	75	7200	3150	6800	2950	6200	2700	5800	2400	9100	3150	8500	2950	7800	2700	7300	2400
	90	6900	3100	6500	2900	6000	2600	5500	2450	8800	3100	8200	2900	7500	2600	7000	2450
90x58	30	2900	1100	2900	1000	2800	950	2600	900	3600	1100	3600	1000	3600	950	3500	900
	40	2900	1100	2900	1000	2600	950	2400	900	3600	1100	3600	1000	3500	950	3200	900
	75	2600	1100	2400	1000	2100	950	1900	900	3600	1100	3300	1000	2900	950	2600	900
	90	2500	1100	2300	1000	2000	950	1800	900	3400	1100	3100	1000	2700	950	2500	900
130x58	30	4900	1550	4500	1450	4100	1350	3700	1200	6300	1550	6100	1450	5500	1350	5100	1200
	40	4500	1550	4200	1450	3700	1350	3400	1250	6100	1550	5700	1450	5100	1350	4600	1250
	75	3800	1550	3500	1450	3100	1350	2800	1300	5200	1550	4700	1450	4200	1350	3800	1300
	90	3600	1550	3300	1450	2900	1350	2600	1300	4900	1550	4500	1450	3900	1350	3600	1300
150x58	30	5600	1750	5200	1650	4600	1550	4300	1350	7100	1750	6700	1650	6200	1550	5800	1350
	40	5200	1750	4800	1650	4300	1550	3900	1400	6800	1750	6400	1650	5800	1550	5300	1400
	75	4400	1750	4000	1650	3500	1550	3200	1500	5900	1750	5400	1650	4800	1550	4400	1500
	90	4100	1750	3800	1650	3300	1550	3000	1500	5600	1750	5200	1650	4500	1550	4100	1500
170x58	30	6200	2000	5800	1850	5200	1750	4800	1500	7800	2000	7400	1850	6800	1750	6400	1500
	40	5800	2000	5400	1850	4800	1750	4400	1550	7400	2000	7000	1850	6400	1750	6000	1550
	75	4900	2000	4500	1850	4000	1750	3700	1650	6500	2000	6100	1850	5400	1750	5000	1650
	90	4700	2000	4300	1850	3800	1750	3400	1650	6200	2000	5800	1850	5100	1750	4700	1650
200x58	30	6900	2350	6500	2200	6100	2000	5600	1700	8600	2350	8200	2200	7600	2000	7200	1700
	40	6500	2350	6200	2200	5600	2050	5200	1750	8200	2350	7800	2200	7200	2050	6800	1750
	75	5700	2350	5300	2200	4700	2050	4300	1950	7300	2350	6800	2200	6300	2050	5800	1950
	90	5400	2350	5000	2200	4400	2050	4100	1950	7000	2350	6600	2200	6000	2050	5500	1950

Single/continuous span roof rafter - with ceiling attached AS 4055 classification N1, N2 and N3 (Cont'd)

Rafter spacing (mm)		450		600		900		1200		450		600		900		1200	
Member size D x B (mm)	Roof mass (kg/m ²)	span	O/H	span	O/H	span	O/H	span	O/H	span	O/H	span	O/H	span	O/H	span	O/H
		Maximum recommended single span (mm)								Maximum recommended continuous span (mm)							
240x58	30	7800	2800	7400	2650	6900	2350	6500	2000	9800	2800	9300	2650	8600	2350	8200	2000
	40	7400	2800	7000	2600	6500	2450	6100	2050	9300	2800	8800	2600	8200	2450	7700	2050
	75	6600	2800	6200	2600	5600	2450	5100	2350	8300	2800	7800	2600	7200	2450	6700	2350
	90	6300	2800	6000	2650	5300	2400	4900	2250	8000	2800	7500	2650	6900	2400	6400	2250
300x58	30	9000	3500	8600	3250	8000	2800	7600	2400	11200	3500	10800	3250	10100	2800	9500	2400
	40	8600	3500	8200	3250	7600	2950	7200	2500	10800	3500	10300	3250	9600	2950	9000	2500
	75	7700	3450	7300	3250	6700	2950	6300	2750	9700	3450	9100	3250	8400	2950	7900	2750
	90	7400	3350	7000	3100	6400	2850	6000	2650	9400	3350	8800	3100	8100	2850	7600	2650
360x58	30	10000	4200	9600	3900	9000	3300	8600	2800	12000	4200	12000	3900	11400	3300	10800	2800
	40	9700	4200	9200	3900	8600	3450	8100	2900	12000	4200	11600	3900	10800	3450	10200	2900
	75	8700	3900	8200	3700	7600	3350	7100	3150	11000	3900	10400	3700	9600	3350	9000	3150
	90	8400	3800	8000	3550	7300	3250	6900	3000	10600	3800	10000	3550	9200	3250	8600	3000
400x58	30	10700	4650	10300	4350	9700	3600	9200	3050	12000	4650	12000	4350	12000	3600	11600	3050
	40	10300	4650	9900	4350	9200	3750	8800	3150	12000	4650	12000	4350	11600	3750	11000	3150
	75	9400	4200	8900	3950	8200	3650	7700	3400	11800	4200	11200	3950	10300	3650	9700	3400
	90	9000	4050	8600	3850	7900	3500	7400	3250	11400	4050	10800	3850	9900	3500	9300	3250
450x58	30	11500	5150	11100	4900	10500	4000	10000	3350	12000	5150	12000	4900	12000	4000	12000	3350
	40	11100	5000	10700	4750	10000	4200	9500	3500	12000	5000	12000	4750	12000	4200	12000	3500
	75	10200	4550	9600	4300	8900	3950	8400	3700	12000	4550	12000	4300	11200	3950	10500	3700
	90	9800	4400	9300	4150	8600	3800	8100	3550	12000	4400	11700	4150	10800	3800	10100 ₅	3550
240x75	30	<i>7950</i>	<i>2150</i>	<i>7600</i>	<i>2150</i>	<i>6850</i>	<i>1800</i>	<i>6400</i>	<i>1525</i>	<i>1000₀</i>	<i>2150</i>	<i>9550</i>	<i>2150</i>	<i>7950</i>	<i>1800</i>	<i>6750</i>	<i>1525</i>
	40	<i>7600</i>	<i>2150</i>	<i>7250</i>	<i>2150</i>	<i>6750</i>	<i>1850</i>	<i>6350</i>	<i>1550</i>	<i>9550</i>	<i>2150</i>	<i>9100</i>	<i>2150</i>	<i>8050</i>	<i>1850</i>	<i>6850</i>	<i>1550</i>
	75	<i>6800</i>	<i>2150</i>	<i>6450</i>	<i>2125</i>	<i>5900</i>	<i>1900</i>	<i>5400</i>	<i>1675</i>	<i>8550</i>	<i>2150</i>	<i>8100</i>	<i>2150</i>	<i>7450</i>	<i>1975</i>	<i>6950</i>	<i>1675</i>
	90	<i>6550</i>	<i>2150</i>	<i>6200</i>	<i>2000</i>	<i>5550</i>	<i>1825</i>	<i>5100</i>	<i>1675</i>	<i>8250</i>	<i>2150</i>	<i>7800</i>	<i>2150</i>	<i>7150</i>	<i>2050</i>	<i>6700</i>	<i>1750</i>
300x75	30	<i>9150</i>	<i>2675</i>	<i>8800</i>	<i>2675</i>	<i>8100</i>	<i>2175</i>	<i>7550</i>	<i>1850</i>	<i>11500</i>	<i>2675</i>	<i>11050</i>	<i>2675</i>	<i>9800</i>	<i>2175</i>	<i>8350</i>	<i>1850</i>
	40	<i>8800</i>	<i>2675</i>	<i>8400</i>	<i>2675</i>	<i>7850</i>	<i>2225</i>	<i>7450</i>	<i>1875</i>	<i>11050</i>	<i>2675</i>	<i>10600</i>	<i>2675</i>	<i>9850</i>	<i>2225</i>	<i>8450₅</i>	<i>1875</i>
	75	<i>7950</i>	<i>2600</i>	<i>7500</i>	<i>2475</i>	<i>6950</i>	<i>2250</i>	<i>6500</i>	<i>2025</i>	<i>10000</i>	<i>2675</i>	<i>9450</i>	<i>2675</i>	<i>8700</i>	<i>2400</i>	<i>8200₁₀</i>	<i>2025</i>
	90	<i>7650</i>	<i>2500</i>	<i>7250</i>	<i>2350</i>	<i>6650</i>	<i>2150</i>	<i>6250</i>	<i>2050</i>	<i>9650</i>	<i>2675</i>	<i>9100</i>	<i>2675</i>	<i>8400</i>	<i>2475</i>	<i>7850₅</i>	<i>2100</i>
400x75	30	<i>10950</i>	<i>3550</i>	<i>10550</i>	<i>3475</i>	<i>10000</i>	<i>2775</i>	<i>9400</i>	<i>2325</i>	<i>12000</i>	<i>3550</i>	<i>12000</i>	<i>3525</i>	<i>12000₅</i>	<i>2775</i>	<i>10700₂₀</i>	<i>2325</i>
	40	<i>10550</i>	<i>3475</i>	<i>10150</i>	<i>3300</i>	<i>9550</i>	<i>2825</i>	<i>9050</i>	<i>2375</i>	<i>12000</i>	<i>3550</i>	<i>12000</i>	<i>3550</i>	<i>12000₁₀</i>	<i>2825</i>	<i>10800₂₀</i>	<i>2375</i>
	75	<i>9650</i>	<i>3175</i>	<i>9150</i>	<i>3000</i>	<i>8500</i>	<i>2800</i>	<i>8000</i>	<i>2575</i>	<i>12000</i>	<i>3550</i>	<i>11500</i>	<i>3500</i>	<i>10650₅</i>	<i>3050</i>	<i>10050₂₅</i>	<i>2575</i>
	90	<i>9350</i>	<i>3075</i>	<i>8850</i>	<i>2900</i>	<i>8200</i>	<i>2700</i>	<i>7700</i>	<i>2500</i>	<i>11750</i>	<i>3550</i>	<i>11150</i>	<i>3375</i>	<i>10300₅</i>	<i>3125</i>	<i>9700₂₅</i>	<i>2675</i>
525x75	30	<i>12000</i>	<i>3950</i>	<i>12000</i>	<i>3950</i>	<i>11900</i>	<i>3500</i>	<i>11400</i>	<i>2925</i>	<i>12000</i>	<i>3950</i>	<i>12000</i>	<i>3950</i>	<i>12000₅</i>	<i>3500</i>	<i>12000₃₀</i>	<i>2925</i>
	40	<i>12000</i>	<i>3950</i>	<i>12000</i>	<i>3950</i>	<i>11400</i>	<i>3575</i>	<i>10900</i>	<i>3000</i>	<i>12000</i>	<i>3950</i>	<i>12000</i>	<i>3950</i>	<i>12000₁₀</i>	<i>3575</i>	<i>12000₃₀</i>	<i>3000</i>
	75	<i>11500</i>	<i>3750</i>	<i>11000</i>	<i>3625</i>	<i>10250</i>	<i>3375</i>	<i>9700</i>	<i>3200</i>	<i>12000</i>	<i>3950</i>	<i>12000</i>	<i>3950</i>	<i>12000₁₅</i>	<i>3850</i>	<i>12000₄₀</i>	<i>3225</i>
	90	<i>11200</i>	<i>3650</i>	<i>10650</i>	<i>3500</i>	<i>9900</i>	<i>3250</i>	<i>9350</i>	<i>3075</i>	<i>12000</i>	<i>3950</i>	<i>12000</i>	<i>3950</i>	<i>12000₂₀</i>	<i>3775</i>	<i>11750₄₅</i>	<i>3350</i>

NOTES:

- Sizes in italics are SmartLVL 14
- D = member depth, B = member breadth, NS = not suitable.
- The above table was based on a batten spacing of 900 mm
- Maximum birdsmouth depth = 30 % of rafter depth
- End bearing lengths = 35 mm at end supports and 35 mm at internal supports for continuous members. Subscript values Indicate the minimum additional bearing length where required to be greater than 35 mm at end supports and 35 mm at Internal supports
- Construction loads shall not be applied to overhangs until a 190x19 (minimum) timber fascia or other fascia of equivalent stiffness is rigidly and permanently attached to the end of rafter overhangs
- Rafter spacing up to 1200 mm
- Not all sizes of SmartLVL in this table are stocked in each state. Please check with your supplier before ordering.

Single/continuous span roof rafter - with ceiling attached AS 4055 classification C1, C2 and C3

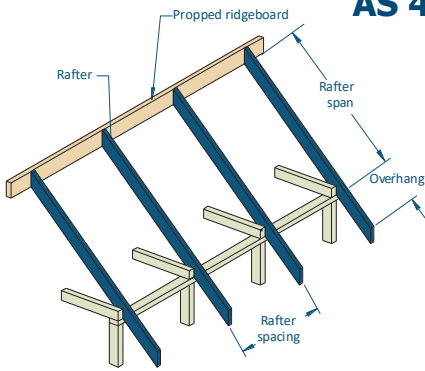

Maximum Birdsmouth = 30% of rafter dept

EXAMPLE:

wind speed = C3
tile roof - 75 kg/m²
rafter/truss spacing = 600 mm
rafter span = 5800 mm
Enter span table at rafter spacing of 600 mm, and read down to a span equal to or greater than 5800 mm

ADOPT:

SmartLVL 15 - 300x42

Rafter spacing (mm)		450		600		900		1200		450		600		900		1200	
Member size D x B	Roof mass (kg/m ²)	span	O/H	span	O/H	span	O/H	span	O/H	span	O/H	span	O/H	span	O/H	span	O/H
		Maximum recommended single span (mm)								Maximum recommended continuous span (mm)							
90x35	30	2200	550	2150	550	2100	525	2100	500	2700	550	2700	550	2700	525	2700	500
	40	2200	550	2150	550	2100	525	2000	500	2700	550	2700	550	2700	525	2700	500
	75	2200	550	2000	525	1750	475	1600	450	2700	550	2700	525	2400	475	2200	450
	90	2100	525	1900	500	1650	450	1500	425	2700	525	2600	500	2250	450	2050	425
120x35	30	3300	750	3250	725	3150	675	2900	625	4150	750	4150	725	4150	675	3750	625
	40	3300	750	3250	725	2900	675	2650	625	4150	750	4150	725	3900	675	3600	625
	75	2950	675	2700	650	2350	575	2150	550	4000	675	3650	650	3200	575	2900	550
	90	2800	650	2550	600	2200	550	2000	525	3750	650	3450	600	3000	550	2750	525
130x35	30	3700	800	3650	775	3400	700	3100	650	4650	800	4650	775	4600	700	4050	650
	40	3700	800	3550	775	3100	700	2850	650	4650	800	4650	775	4250	700	3850	650
	75	3200	725	2900	675	2550	625	2350	575	4300	725	3950	675	3450	625	3150	575
	90	3000	700	2750	650	2400	600	2200	550	4100	700	3750	650	3250	600	3000	550
140x35	30	4100	850	4050	825	3650	750	3350	700	5150	850	5150	825	4950	750	4350	700
	40	4100	850	3800	825	3350	750	3050	700	5150	850	5150	825	4550	750	4150	700
	75	3400	775	3150	725	2750	650	2500	600	4650	775	4250	725	3750	650	3400	600
	90	3250	725	2950	675	2600	625	2350	575	4400	725	4000	675	3500	625	3200	575
150x35	30	4550	925	4400	875	3900	775	3600	725	5500	925	5500	875	5300	775	4650	725
	40	4400	925	4050	875	3600	775	3300	725	5500	925	5500	875	4850	775	4450	725
	75	3650	800	3350	750	2950	675	2700	625	4950	800	4550	750	4000	675	3650	625
	90	3450	775	3150	725	2800	650	2550	600	4700	775	4300	725	3750	650	3450	600
170x35	30	5300	1025	4950	950	4400	875	4050	800	6250	1025	6250	950	6000	875	5250	800
	40	4950	1000	4550	950	4050	875	3700	800	6250	1000	6150	950	5500	875	5050	800
	75	4150	875	3800	825	3350	750	3050	700	5600	875	5150	825	4500	750	4100	700
	90	3900	850	3550	800	3150	725	2850	675	5300	850	4850	800	4250	725	3900	675
190x35	30	5900	1125	5500	1050	4900	950	4500	875	7000	1125	7000	1050	6500	950	5850	875
	40	5500	1100	5100	1025	4500	950	4150	875	7000	1100	6650	1025	6100	950	5600	875
	75	4600	950	4200	900	3700	800	3400	750	6200	950	5700	900	5050	800	4600	750
	90	4350	925	4000	850	3500	775	3200	725	5900	925	5400	850	4750	775	4350	725
200x35	30	6150	1150	5800	1075	5150	975	4750	900	7350	1150	7350	1075	6750	975	6150	900
	40	5800	1125	5350	1075	4750	975	4350	900	7350	1125	6900	1075	6300	975	5900	900
	75	4850	1000	4450	925	3900	850	3550	800	6400	1000	6000	925	5300	850	4850	800
	90	4600	950	4200	875	3700	800	3350	750	6150	950	5700	875	5000	800	4550	750
240x35	30	7000	1325	6650	1250	6100	1125	5650	1050	8800	1325	8350	1250	7700	1125	7200	1050
	40	6650	1275	6250	1225	5650	1125	5200	1050	8350	1275	7850	1225	7200	1125	6750	1050
	75	5750	1125	5300	1050	4650	975	4250	900	7300	1125	6850	1050	6250	975	5800	900
	90	5450	1075	5000	1025	4400	925	4050	850	7050	1075	6600	1025	6000	925	5450	850
90x42	30	2500	600	2400	550	2400	400	2200	350	3100	600	3100	550	2700	400	2200	350
	40	2500	650	2400	550	2300	400	2100	350	3100	650	3100	550	2700	400	2200	350
	75	2400	650	2200	550	1900	450	1700	350	3100	650	3000	550	2600	450	2300	350
	90	2300	650	2100	550	1800	450	1600	400	3100	650	2800	550	2500	450	2200	400
120x42	30	3800	800	3700	650	3200	550	2900	450	4700	800	4400	650	3500	550	2900	450
	40	3800	800	3500	650	3100	550	2800	450	4700	800	4500	650	3600	550	3000	450
	75	3200	800	2900	700	2600	550	2300	450	4300	800	4000	700	3500	550	3100	450
	90	3000	850	2700	700	2400	550	2200	500	4100	850	3700	700	3300	550	3000	500

Single/continuous span roof rafter - with ceiling attached AS 4055 classification C1, C2 and C3 (cont'd)

Rafter spacing (mm)		450		600		900		1200		450		600		900		1200	
Member size D x B (mm)	Roof mass (kg/m ²)	span	O/H	span	O/H	span	O/H	span	O/H	span	O/H	span	O/H	span	O/H	span	O/H
		Maximum recommended single span (mm)								Maximum recommended continuous span (mm)							
130x42	30	4200	850	4000	700	3500	550	3200	500	5300	850	4800	700	3800	550	3200	500
	40	4100	850	3800	700	3400	550	3100	500	5300	850	4800	700	3800	550	3200	500
	75	3400	900	3100	750	2800	600	2500	500	4700	900	4300	750	3800	600	3300	500
	90	3300	900	3000	750	2600	600	2400	500	4400	900	4100	750	3600	600	3200	500
140x42	30	4700	900	4300	750	3800	600	3400	500	6000	900	5100	750	4100	600	3400	500
	40	4500	900	4100	750	3600	600	3300	500	6000	900	5200	750	4100	600	3500	500
	75	3700	950	3400	800	3000	650	2700	550	5000	950	4600	800	4100	650	3600	550
150x42	90	3500	950	3200	800	2800	650	2600	550	4800	950	4400	800	3800	650	3500	550
	30	5100	950	4700	800	4100	650	3700	550	6400	950	5500	800	4400	650	3700	550
	40	4800	950	4400	800	3900	650	3600	550	6300	950	5500	800	4400	650	3700	550
	75	4000	1000	3600	850	3200	650	2900	550	5400	1000	4900	850	4300	650	3800	550
170x42	90	3700	1000	3400	850	3000	700	2700	550	5100	1000	4700	850	4100	700	3700	550
	30	5800	1050	5300	900	4600	700	4100	600	7200	1050	6100	900	4900	700	4100	600
	40	5300	1050	4900	900	4400	700	4000	600	6900	1050	6200	900	5000	700	4200	600
	75	4500	1100	4100	950	3600	750	3300	600	6100	1100	5600	950	4900	750	4300	600
190x42	90	4200	1100	3900	950	3400	750	3100	650	5800	1100	5300	950	4600	750	4200	650
	30	6300	1150	5900	950	5200	750	4600	650	7900	1150	6800	950	5500	750	4600	650
	40	5900	1150	5500	1000	4900	750	4500	650	7500	1150	6900	1000	5500	750	4700	650
	75	5000	1200	4600	1000	4000	800	3700	700	6600	1200	6100	1000	5500	800	4800	700
200x42	90	4700	1200	4300	1000	3800	800	3500	700	6300	1200	5900	1000	5200	800	4700	700
	30	6500	1200	6200	1000	5400	800	4800	650	8200	1200	7100	1000	5700	800	4800	650
	40	6200	1200	5800	1000	5100	800	4700	700	7800	1200	7200	1000	5800	800	4900	700
	75	5200	1250	4800	1050	4200	850	3900	700	6800	1250	6400	1050	5800	850	5100	700
240x42	90	5000	1250	4500	1050	4000	850	3700	700	6500	1250	6100	1050	5500	850	5000	700
	30	7300	1350	7000	1150	6400	900	5800	750	9200	1350	8400	1150	6800	900	5800	750
	40	7000	1400	6600	1150	6100	950	5600	800	8800	1400	8300	1150	6900	950	5800	800
	75	6200	1450	5700	1200	5100	950	4600	800	7800	1450	7300	1200	6700	950	6000 ₁₀	800
300x42	90	5900	1450	5400	1250	4800	1000	4400	850	7400	1450	7000	1250	6400	1000	6000 ₁₅	850
	30	8500	1650	8100	1400	7500	1100	7100	950	10700	1650	10200	1400	8400 ₅	1100	7100 ₁₀	950
	40	8100	1650	7700	1400	7100	1100	6700	950	10200	1650	9700	1400	8400 ₅	1100	7200 ₁₅	950
	75	7200	1750	6800	1450	6200	1150	5800	1000	9100	1750	8500	1450	7800 ₁₀	1150	7300 ₂₅	1000
90	6900	1750	6500	1500	6000	1150	5500	1000	8800	1750	8200	1500	7500 ₁₀	1150	7000 ₂₅	1000	
90x58	30	2900	750	2900	650	2700	500	2400	450	3600	750	3600	650	3200	500	2600	450
	40	2900	750	2900	650	2600	500	2400	450	3600	750	3600	650	3200	500	2700	450
	75	2600	800	2400	650	2100	550	1900	450	3600	800	3300	650	2900	550	2600	450
	90	2500	800	2300	650	2000	550	1800	450	3400	800	3100	650	2700	550	2500	450
130x58	30	4900	1000	4500	850	3900	700	3600	550	6300	1000	5700	850	4500	700	3800	550
	40	4500	1000	4200	850	3700	700	3400	600	6100	1000	5700	850	4600	700	3800	600
	75	3800	1050	3500	900	3100	700	2800	600	5200	1050	4700	900	4200	700	3800	600
150x58	90	3600	1050	3300	900	2900	700	2600	600	4900	1050	4500	900	3900	700	3600	600
	30	5600	1100	5200	950	4500	750	4100	650	7100	1100	6500	950	5200	750	4400	650
	40	5200	1150	4800	950	4300	750	3900	650	6800	1150	6400	950	5200	750	4400	650
	75	4400	1150	4000	1000	3500	800	3200	700	5900	1150	5400	1000	4800	800	4400	700
170x58	90	4100	1200	3800	1000	3300	800	3000	700	5600	1200	5200	1000	4500	800	4100	700
	30	6200	1250	5800	1050	5100	850	4700	700	7800	1250	7300	1050	5800	850	4900	700
	40	5800	1250	5400	1050	4800	850	4400	700	7400	1250	7000	1050	5900	850	5000	700
	75	4900	1300	4500	1100	4000	900	3700	750	6500	1300	6100	1100	5400	900	5000	750
200x58	90	4700	1300	4300	1100	3800	900	3400	750	6200	1300	5800	1100	5100	900	4700	750
	30	6900	1400	6500	1200	6000	950	5500	800	8600	1400	8200	1200	6800	950	5800	800
	40	6500	1450	6200	1200	5600	950	5200	800	8200	1450	7800	1200	6800	950	5800	800
	75	5700	1500	5300	1250	4700	1000	4300	850	7300	1500	6800	1250	6300	1000	5800	850
90	5400	1500	5000	1300	4400	1000	4100	850	7000	1500	6600	1300	6000	1000	5500	850	

Single/continuous span roof rafter - with ceiling attached AS 4055 classification C1, C2 and C3 (cont'd)

Rafter spacing (mm)		450		600		900		1200		450		600		900		1200	
Member size D x B (mm)	Roof mass (kg/m ²)	span	O/H	span	O/H	span	O/H	span	O/H	span	O/H	span	O/H	span	O/H	span	O/H
		Maximum recommended single span (mm)								Maximum recommended continuous span (mm)							
240x58	30	7800	1650	7400	1400	6900	1100	6500	950	9800	1650	9300	1400	8000	1100	6800	950
	40	7400	1650	7000	1400	6500	1100	6100	950	9300	1650	8800	1400	8100	1100	6900	950
	75	6600	1750	6200	1450	5600	1150	5100	1000	8300	1750	7800	1450	7200	1150	6700	1000
	90	6300	1750	6000	1500	5300	1200	4900	1000	8000	1750	7500	1500	6900	1200	6400	1000
300x58	30	9000	2000	8600	1700	8000	1300	7600	1100	11200	2000	10800	1700	9900	1300	8400 ₅	1100
	40	8600	2000	8200	1700	7600	1350	7200	1150	10800	2000	10300	1700	9600	1350	8500 ₅	1150
	75	7700	2100	7300	1750	6700	1400	6300	1150	9700	2100	9100	1750	8400	1400	7900 ₁₀	1150
	90	7400	2100	7000	1800	6400	1400	6000	1200	9400	2100	8800	1800	8100	1400	7600 ₁₀	1200
360x58	30	10000	2300	9600	1950	9000	1550	8600	1300	12000	2300	12000	1950	11400 ₅	1550	9900 ₁₅	1300
	40	9700	2350	9200	2000	8600	1550	8100	1300	12000	2350	11600	2000	10800 ₅	1550	10000 ₁₅	1300
	75	8700	2450	8200	2050	7600	1600	7100	1350	11000	2450	10400	2050	9600 ₅	1600	9000 ₂₀	1350
	90	8400	2450	8000	2100	7300	1650	6900	1400	10600	2450	10000	2100	9200 ₅	1650	8600 ₂₀	1400
400x58	30	10700	2550	10300	2150	9700	1700	9200	1400	12000	2550	12000	2150	12000 ₁₀	1700	10800 ₂₀	1400
	40	10300	2550	9900	2150	9200	1700	8800	1400	12000	2550	12000	2150	11600 ₁₀	1700	10900 ₂₅	1400
	75	9400	2650	8900	2250	8200	1750	7700	1500	11800	2650	11200	2250	10300 ₅	1750	9700 ₂₅	1500
	90	9000	2700	8600	2300	7900	1800	7400	1500	11400	2700	10800	2300	9900 ₁₀	1800	9300 ₂₅	1500
450x58	30	11500	2800	11100	2350	10500	1850	10000	1550	12000	2800	12000	2350	12000 ₁₀	1850	11900 ₃₀	1550
	40	11100	2800	10700	2400	10000	1850	9500	1550	12000	2800	12000	2400	12000 ₁₀	1850	12000 ₃₀	1550
	75	10200	2950	9600	2450	8900	1950	8400	1650	12000	2950	12000	2450	11200 ₁₅	1950	10500 ₃₀	1650
	90	9800	3000	9300	2500	8600	1950	8100	1650	12000	3000	11700	2500	10800 ₁₅	1950	10100 ₃₀	1650
240x75	30	<i>7950</i>	<i>2150</i>	<i>7600</i>	<i>2150</i>	<i>6850</i>	<i>1800</i>	<i>6400</i>	<i>1525</i>	<i>1000₀</i>	<i>2150</i>	<i>9550</i>	<i>2150</i>	<i>7950</i>	<i>1800</i>	<i>6750</i>	<i>1525</i>
	40	<i>7600</i>	<i>2150</i>	<i>7250</i>	<i>2150</i>	<i>6750</i>	<i>1850</i>	<i>6350</i>	<i>1550</i>	<i>9550</i>	<i>2150</i>	<i>9100</i>	<i>2150</i>	<i>8050</i>	<i>1850</i>	<i>6850</i>	<i>1550</i>
	75	<i>6800</i>	<i>2150</i>	<i>6450</i>	<i>2125</i>	<i>5900</i>	<i>1900</i>	<i>5400</i>	<i>1675</i>	<i>8550</i>	<i>2150</i>	<i>8100</i>	<i>2150</i>	<i>7450</i>	<i>1975</i>	<i>6950</i>	<i>1675</i>
	90	<i>6550</i>	<i>2150</i>	<i>6200</i>	<i>2000</i>	<i>5550</i>	<i>1825</i>	<i>5100</i>	<i>1675</i>	<i>8250</i>	<i>2150</i>	<i>7800</i>	<i>2150</i>	<i>7150</i>	<i>2050</i>	<i>6700</i>	<i>1750</i>
300x75	30	<i>9150</i>	<i>2675</i>	<i>8800</i>	<i>2675</i>	<i>8100</i>	<i>2175</i>	<i>7550</i>	<i>1850</i>	<i>11500</i>	<i>2675</i>	<i>11050</i>	<i>2675</i>	<i>9800</i>	<i>2175</i>	<i>8350</i>	<i>1850</i>
	40	<i>8800</i>	<i>2675</i>	<i>8400</i>	<i>2675</i>	<i>7850</i>	<i>2225</i>	<i>7450</i>	<i>1875</i>	<i>11050</i>	<i>2675</i>	<i>10600</i>	<i>2675</i>	<i>9850</i>	<i>2225</i>	<i>8450₅</i>	<i>1875</i>
	75	<i>7950</i>	<i>2600</i>	<i>7500</i>	<i>2475</i>	<i>6950</i>	<i>2250</i>	<i>6500</i>	<i>2025</i>	<i>10000</i>	<i>2675</i>	<i>9450</i>	<i>2675</i>	<i>8700</i>	<i>2400</i>	<i>8200₁₀</i>	<i>2025</i>
	90	<i>7650</i>	<i>2500</i>	<i>7250</i>	<i>2350</i>	<i>6650</i>	<i>2150</i>	<i>6250</i>	<i>2050</i>	<i>9650</i>	<i>2675</i>	<i>9100</i>	<i>2675</i>	<i>8400</i>	<i>2475</i>	<i>7850₅</i>	<i>2100</i>
400x75	30	<i>10950</i>	<i>3550</i>	<i>10550</i>	<i>3475</i>	<i>10000</i>	<i>2775</i>	<i>9400</i>	<i>2325</i>	<i>12000</i>	<i>3550</i>	<i>12000</i>	<i>3525</i>	<i>12000₅</i>	<i>2775</i>	<i>10700₂₀</i>	<i>2325</i>
	40	<i>10550</i>	<i>3475</i>	<i>10150</i>	<i>3300</i>	<i>9550</i>	<i>2825</i>	<i>9050</i>	<i>2375</i>	<i>12000</i>	<i>3550</i>	<i>12000</i>	<i>3550</i>	<i>12000₁₀</i>	<i>2825</i>	<i>10800₂₀</i>	<i>2375</i>
	75	<i>9650</i>	<i>3175</i>	<i>9150</i>	<i>3000</i>	<i>8500</i>	<i>2800</i>	<i>8000</i>	<i>2575</i>	<i>12000</i>	<i>3550</i>	<i>11500</i>	<i>3500</i>	<i>10650₅</i>	<i>3050</i>	<i>10050₂₅</i>	<i>2575</i>
	90	<i>9350</i>	<i>3075</i>	<i>8850</i>	<i>2900</i>	<i>8200</i>	<i>2700</i>	<i>7700</i>	<i>2500</i>	<i>11750</i>	<i>3550</i>	<i>11150</i>	<i>3375</i>	<i>10300₅</i>	<i>3125</i>	<i>9700₂₅</i>	<i>2675</i>
525x75	30	<i>12000</i>	<i>3950</i>	<i>12000</i>	<i>3950</i>	<i>11900</i>	<i>3500</i>	<i>11400</i>	<i>2925</i>	<i>12000</i>	<i>3950</i>	<i>12000</i>	<i>3950</i>	<i>12000₅</i>	<i>3500</i>	<i>12000₃₀</i>	<i>2925</i>
	40	<i>12000</i>	<i>3950</i>	<i>12000</i>	<i>3950</i>	<i>11400</i>	<i>3575</i>	<i>10900</i>	<i>3000</i>	<i>12000</i>	<i>3950</i>	<i>12000</i>	<i>3950</i>	<i>12000₁₀</i>	<i>3575</i>	<i>12000₃₀</i>	<i>3000</i>
	75	<i>11500</i>	<i>3750</i>	<i>11000</i>	<i>3625</i>	<i>10250</i>	<i>3375</i>	<i>9700</i>	<i>3200</i>	<i>12000</i>	<i>3950</i>	<i>12000</i>	<i>3950</i>	<i>12000₁₅</i>	<i>3850</i>	<i>12000₄₀</i>	<i>3225</i>
	90	<i>11200</i>	<i>3650</i>	<i>10650</i>	<i>3500</i>	<i>9900</i>	<i>3250</i>	<i>9350</i>	<i>3075</i>	<i>12000</i>	<i>3950</i>	<i>12000</i>	<i>3950</i>	<i>12000₂₀</i>	<i>3775</i>	<i>11750₄₅</i>	<i>3350</i>

NOTES:

- Sizes in italics are SmartLVL 14
- D = member depth, B = member breadth, NS = not suitable.
- The above table was based on a batten spacing of 900 mm
- Maximum birdsmouth depth = 30 % of rafter depth
- End bearing lengths = 35 mm at end supports and 35 mm at internal supports for continuous members. Subscript values indicate the minimum additional bearing length where required to be greater than 35 mm at end supports and 35 mm at internal supports
- Construction loads shall not be applied to overhangs until a 190x19 (minimum) timber fascia or other fascia of equivalent stiffness is rigidly and permanently attached to the end of rafter overhangs
- Rafter spacing up to 1200 mm
- Not all sizes of SmartLVL in this table are stocked in each state.

Single/continuous span roof rafter - without ceiling attached

AS 4055 classification N1, N2 and N3

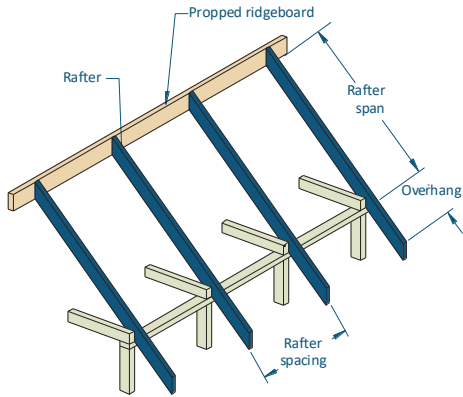

Maximum Birdsmouth = 30% of rafter dept

EXAMPLE:

wind speed = N3
 sheet roof = 40 kg/m²
 rafter/truss spacing = 600 mm
 rafter span = 5800 mm (single span)
 Enter span table at rafter spacing of 600 mm, and read down to a span equal to or greater than 5800 mm

ADOPT:

SmartLVL 14 - 240x35

Rafter spacing (mm)		450		600		900		1200		450		600		900		1200	
Member size DxB (mm)	Roof mass (kg/m ²)	span	O/H	span	O/H	span	O/H	span	O/H	span	O/H	span	O/H	span	O/H	span	O/H
		Maximum recommended single span (mm)								Maximum recommended continuous span (mm)							
90x35	10	2200	550	2150	550	2100	525	2100	500	2700	550	2700	550	2700	525	2700	500
	20	2200	550	2150	550	2100	525	2100	500	2700	550	2700	550	2700	525	2700	500
	40	2200	550	2150	550	2100	525	2000	500	2700	550	2700	550	2700	525	2700	500
	60	2200	550	2150	550	1900	500	1750	475	2700	550	2700	550	2600	500	2350	475
120x35	10	3300	750	3250	725	3200	675	3100	625	4150	750	4150	725	4150	675	3600	625
	20	3300	750	3250	725	3200	675	3100	625	4150	750	4150	725	4150	675	3650	625
	40	3300	750	3250	725	2900	675	2650	625	4150	750	4150	725	3900	675	3600	625
	60	3150	725	2900	675	2550	625	2300	575	4150	725	3900	675	3450	625	3150	575
130x35	10	3700	800	3650	775	3550	700	3450	650	4650	800	4650	775	4600	700	3900	650
	20	3700	800	3650	775	3550	700	3450	650	4650	800	4650	775	4650	700	3950	650
	40	3700	800	3550	775	3100	700	2850	650	4650	800	4650	775	4250	700	3850	650
	60	3400	750	3100	725	2750	650	2500	600	4600	750	4250	725	3750	650	3400	600
140x35	10	4100	850	4050	825	3950	750	3700	700	5150	850	5150	825	4950	750	4150	700
	20	4100	850	4050	825	3950	750	3700	700	5150	850	5150	825	5050	750	4250	700
	40	4100	850	3800	825	3350	750	3050	700	5150	850	5150	825	4550	750	4150	700
	60	3650	800	3350	750	2950	675	2700	650	4950	800	4550	750	4000	675	3650	650
150x35	10	4550	925	4450	875	4300	775	3950	725	5500	925	5500	875	5250	775	4450	725
	20	4550	925	4450	875	4300	775	3950	725	5500	925	5500	875	5400	775	4550	725
	40	4400	925	4050	875	3600	775	3300	725	5500	925	5500	875	4850	775	4450	725
	60	3900	850	3600	800	3150	725	2900	675	5300	850	4850	800	4300	725	3900	675
170x35	10	5300	1025	5200	950	4850	875	4500	800	6250	1025	6250	950	5950	875	5050	800
	20	5300	1025	5200	950	4850	875	4500	800	6250	1025	6250	950	6050	875	5150	800
	40	4950	1000	4550	950	4050	875	3700	800	6250	1000	6150	950	5500	875	5050	800
	60	4400	925	4050	875	3550	800	3250	750	6000	925	5500	875	4850	800	4450	750
190x35	10	5900	1125	5800	1050	5250	950	4900	875	7000	1125	7000	1050	6600	950	5600	875
	20	5900	1125	5800	1050	5250	950	4900	875	7000	1125	7000	1050	6600	950	5700	875
	40	5500	1100	5100	1025	4500	950	4150	875	7000	1100	6650	1025	6100	950	5600	875
	60	4900	1000	4500	950	4000	850	3650	800	6500	1000	6100	950	5400	850	4950	800
200x35	10	6150	1150	6050	1075	5450	975	5100	900	7350	1150	7350	1075	6850	975	5850	900
	20	6150	1150	6050	1075	5450	975	5100	900	7350	1150	7350	1075	6850	975	6000	900
	40	5800	1125	5350	1075	4750	975	4350	900	7350	1125	6900	1075	6300	975	5900	900
	60	5150	1050	4750	975	4200	900	3850	825	6750	1050	6300	975	5700	900	5200	825
240x35	10	7350	1325	6900	1250	6250	1125	5800	1050	8800	1325	8700	1250	7850	1125	7000	1050
	20	7350	1325	6900	1250	6250	1125	5800	1050	8800	1325	8700	1250	7850	1125	7150	1050
	40	6650	1275	6250	1225	5650	1125	5200	1050	8350	1275	7850	1225	7200	1125	6750	1050
	60	6100	1175	5650	1100	5000	1025	4600	950	7700	1175	7200	1100	6600	1025	6150	950
90x42	10	2500	1000	2400	900	2400	800	2300	700	3100	1000	3100	900	3100	800	3100	700
	20	2500	1000	2400	900	2400	850	2300	750	3100	1000	3100	900	3100	850	3100	750
	40	2500	1000	2400	900	2300	850	2100	800	3100	1000	3100	900	3100	850	2900	800
	60	2500	1000	2300	900	2100	850	1900	800	3100	1000	3100	900	2800	850	2600	800
120x42	10	3800	1300	3700	1200	3600	1050	3500	900	4700	1300	4700	1200	4700	1050	4700	900
	20	3800	1300	3700	1200	3600	1050	3500	900	4700	1300	4700	1200	4700	1050	4700	900
	40	3800	1300	3500	1200	3100	1100	2800	1000	4700	1300	4700	1200	4200	1100	3900	1000
	60	3400	1300	3100	1200	2700	1100	2500	1050	4600	1300	4200	1200	3700	1100	3400	1050

Single/continuous span roof rafter - without ceiling attached AS 4055 classification N1, N2 and N3 (Cont'd)

Rafter spacing (mm)		450		600		900		1200		450		600		900		1200	
Member size DxB (mm)	Roof mass (kg/m ²)	span	O/H	span	O/H	span	O/H	span	O/H	span	O/H	span	O/H	span	O/H	span	O/H
		Maximum recommended single span (mm)								Maximum recommended continuous span (mm)							
130x42	10	4200	1400	4200	1300	4000	1100	3900	950	5300	1400	5300	1300	5300	1100	5300	950
	20	4200	1400	4200	1300	4000	1150	3800	1000	5300	1400	5300	1300	5300	1150	5200	1000
	40	4100	1400	3800	1300	3400	1200	3100	1050	5300	1400	5200	1300	4600	1200	4200	1050
	60	3700	1400	3400	1300	3000	1200	2700	1150	5000	1400	4600	1300	4100	1200	3700	1150
140x42	10	4700	1500	4600	1400	4500	1150	4300	1000	5900	1500	5900	1400	5900	1150	5900	1000
	20	4700	1500	4600	1400	4500	1200	4100	1050	5900	1500	5900	1400	5900	1200	5600	1050
	40	4500	1500	4100	1400	3600	1300	3300	1100	6000	1500	5600	1400	4900	1300	4500	1100
	60	4000	1500	3600	1400	3200	1300	2900	1200	5400	1500	4900	1400	4400	1300	4000	1200
150x42	10	5200	1600	5100	1500	4900	1250	4700	1050	6600	1600	6600	1500	6600	1250	6500	1050
	20	5200	1600	5100	1500	4800	1250	4400	1100	6600	1600	6600	1500	6300	1250	6000	1100
	40	4800	1600	4400	1500	3900	1350	3600	1150	6300	1600	6000	1500	5300	1350	4800	1150
	60	4200	1600	3900	1500	3400	1400	3100	1250	5800	1600	5300	1500	4700	1400	4300	1250
170x42	10	6100	1800	6000	1700	5800	1350	5400	1150	8000	1800	8000	1700	7900	1350	7400	1150
	20	6100	1800	5900	1700	5300	1400	4900	1200	7900	1800	7500	1700	6900	1400	6500	1200
	40	5300	1800	4900	1700	4400	1500	4000	1300	6900	1800	6500	1700	6000	1500	5500	1300
	60	4800	1800	4400	1700	3900	1550	3500	1400	6400	1800	6000	1700	5300	1550	4800	1400
190x42	10	7200	2000	7000	1850	6700	1500	6100	1250	9300	2000	9000	1850	8500	1500	8100	1250
	20	6700	2000	6400	1900	5900	1550	5500	1300	8500	2000	8100	1900	7500	1550	7000	1300
	40	5900	2000	5500	1900	4900	1650	4500	1400	7500	2000	7000	1900	6500	1650	6100	1400
	60	5300	2000	4900	1900	4300	1750	4000	1550	6900	2000	6500	1900	5900	1750	5400	1550
200x42	10	7700	2100	7400	1950	7000	1550	6400	1350	9600	2100	9300	1950	8700	1550	8300	1350
	20	7000	2100	6600	1950	6200	1600	5800	1350	8800	2100	8300	1950	7700	1600	7300	1350
	40	6200	2100	5800	1950	5100	1750	4700	1500	7800	2100	7300	1950	6700	1750	6300	1500
	60	5600	2100	5100	1950	4500	1850	4200	1600	7100	2100	6700	1950	6100	1850	5700	1600
240x42	10	8600	2500	8300	2300	7800	1800	7500	1550	10800	2500	10400	2300	9800	1800	9400	1550
	20	7900	2500	7500	2350	7000	1850	6600	1600	9800	2500	9400	2350	8800	1850	8300	1600
	40	7000	2500	6600	2350	6100	2000	5600	1700	8800	2500	8300	2350	7700	2000	7200	1700
	60	6500	2500	6100	2350	5400	2200	5000	1850	8100	2500	7600	2350	7000	2200	6500	1850
300x42	10	9800	3150	9500	2750	9000	2200	8700	1850	12000	3150	11900	2750	11400	2200	10900	1850
	20	9100	3150	8700	2850	8100	2250	7700	1900	11400	3150	10900	2850	10200	2250	9700	1900
	40	8100	3150	7700	2950	7100	2450	6700	2050	10200	3150	9700	2950	9000	2450	8400	2050
	60	7600	3150	7100	2950	6500	2650	6100	2250	9500	3150	8900	2950	8200	2650	7700	2250
90x58	10	2900	1100	2900	1000	2800	950	2700	850	3600	1100	3600	1000	3600	950	3600	850
	20	2900	1100	2900	1000	2800	950	2700	850	3600	1100	3600	1000	3600	950	3600	850
	40	2900	1100	2900	1000	2600	950	2400	900	3600	1100	3600	1000	3500	950	3200	900
	60	2800	1100	2600	1000	2300	950	2100	900	3600	1100	3500	1000	3100	950	2800	900
130x58	10	4900	1550	4800	1450	4700	1300	4500	1100	6300	1550	6300	1450	6300	1300	6300	1100
	20	4900	1550	4800	1450	4500	1350	4200	1150	6300	1550	6300	1450	6100	1350	5700	1150
	40	4500	1550	4200	1450	3700	1350	3400	1250	6100	1550	5700	1450	5100	1350	4600	1250
	60	4100	1550	3700	1450	3300	1350	3000	1300	5500	1550	5100	1450	4500	1350	4100	1300
150x58	10	6000	1750	5900	1650	5700	1450	5300	1250	7700	1750	7800	1650	7600	1450	7300	1250
	20	6000	1750	5700	1650	5200	1500	4800	1300	7600	1750	7300	1650	6800	1500	6400	1300
	40	5200	1750	4800	1650	4300	1550	3900	1400	6800	1750	6400	1650	5800	1550	5300	1400
	60	4600	1750	4300	1650	3800	1550	3500	1500	6200	1750	5800	1650	5200	1550	4700	1500
170x58	10	7100	2000	7000	1850	6600	1650	6100	1400	9000	2000	8700	1850	8300	1650	7900	1400
	20	6600	2000	6300	1850	5800	1700	5400	1450	8300	2000	7900	1850	7400	1700	7000	1450
	40	5800	2000	5400	1850	4800	1750	4400	1550	7400	2000	7000	1850	6400	1750	6000	1550
	60	5200	2000	4800	1850	4300	1750	3900	1650	6800	2000	6400	1850	5800	1750	5300	1650
200x58	10	7900	2350	7700	2200	7300	1850	7000	1600	10000	2350	9700	2200	9200	1850	8800	1600
	20	7300	2350	7000	2200	6500	1950	6200	1650	9200	2350	8800	2200	8200	1950	7800	1650
	40	6500	2350	6200	2200	5600	2050	5200	1750	8200	2350	7800	2200	7200	2050	6800	1750
	60	6100	2350	5600	2200	5000	2050	4600	1900	7600	2350	7200	2200	6600	2050	6200	1900

Single/continuous span roof rafter - without ceiling attached AS 4055 classification N1, N2 and N3 (Cont'd)

Rafter spacing (mm)		450		600		900		1200		450		600		900		1200	
Member size DxB (mm)	Roof mass (kg/m ²)	span	O/H	span	O/H	span	O/H	span	O/H	span	O/H	span	O/H	span	O/H	span	O/H
Maximum recommended single span (mm)										Maximum recommended continuous span (mm)							
240x58	10	8800	2800	8600	2600	8200	2200	7900	1850	11100	2800	10800	2600	10300	2200	9900	1850
	20	8200	2800	7900	2650	7400	2250	7000	1900	10300	2800	9900	2650	9300	2250	8800	1900
	40	7400	2800	7000	2600	6500	2450	6100	2050	9300	2800	8800	2600	8200	2450	7700	2050
	60	6900	2800	6500	2600	6000	2450	5500	2250	8700	2800	8200	2600	7500	2450	7000	2250
300x58	10	10100	3500	9800	3250	9400	2650	9100	2250	12000	3500	12000	3250	11900	2650	11400	2250
	20	9400	3500	9100	3250	8600	2700	8200	2300	11900	3500	11400	3250	10800	2700	10300	2300
	40	8600	3500	8200	3250	7600	2950	7200	2500	10800	3500	10300	3250	9600	2950	9000	2500
	60	8000	3500	7600	3250	7000	3050	6600	2700	10100	3500	9500	3250	8800	3050	8300	2700
360x58	10	11200	4200	10900	3900	10500	3050	10200	2600	12000	4200	12000	3900	12000	3050	12000	2600
	20	10500	4200	10200	3900	9600	3200	9200	2700	12000	4200	12000	3900	12000	3200	11600	2700
	40	9700	4200	9200	3900	8600	3450	8100	2900	12000	4200	11600	3900	10800	3450	10200	2900
	60	9100	4050	8600	3850	8000	3500	7500	3150	11400	4050	10800	3850	10000	3500	9400	3150
400x58	10	11800	4650	11600	4300	11200	3350	10900	2850	12000	4650	12000	4300	12000	3350	12000	2850
	20	11200	4650	10900	4350	10300	3500	9900	2950	12000	4650	12000	4350	12000	3500	12000	2950
	40	10400	4650	9900	4350	9200	3750	8800	3150	12000	4650	12000	4350	11600	3750	11000	3150
	60	9700	4350	9200	4150	8600	3800	8100	3450	12000	4350	11600	4150	10800	3800	10200	3450
450x58	10	12000	5200	12000	4800	12000	3700	11700	3150	12000	5200	12000	4800	12000	3700	12000	3150
	20	12000	5200	11700	4900	11100	3850	10700	3250	12000	5200	12000	4900	12000	3850	12000	3250
	40	11100	5000	10700	4750	10000	4200	9500	3500	12000	5000	12000	4750	12000	4200	12000	3500
	60	10500	4700	10000	4450	9300	4100	8800	3850	12000	4700	12000	4450	11700	4100	11000	3850
240x75	10	8950	2150	8750	2150	8350	2150	7800	2150	11250	2150	11000	2150	10500	2150	9800	2150
	20	8350	2150	8050	2150	7600	2150	7250	2150	10550	2150	10150	2150	9550	2150	9100	2150
	40	7600	2150	7250	2150	6750	2150	6350	2050	9550	2150	9100	2150	8450	2150	8000	2150
	60	7100	2150	6750	2150	6200	2000	5750	1850	8950	2150	8450	2150	7800	2150	7300	2150
300x75	10	10150	2675	9950	2675	9600	2675	9200	2675	12000	2675	12000	2675	12000	2675	11550	2675
	20	9600	2675	9300	2675	8800	2675	8400	2675	12000	2675	11700	2675	11050	2675	10600	2675
	40	8800	2675	8400	2675	7850	2550	7450	2450	11050	2675	10600	2675	9850	2675	9350	2675
	60	8250	2675	7850	2550	7250	2350	6850	2250	10400	2675	9850	2675	9100	2675	8600	2625
400x75	10	11950	3550	11750	3550	11400	3550	11050	3550	12000	3550	12000	3550	12000	3550	12000	3550
	20	11400	3550	11050	3550	10550	3475	10150	3300	12000	3550	12000	3550	12000	3550	12000	3550
	40	10550	3475	10150	3300	9550	3150	9050	2975	12000	3550	12000	3550	12000	3550	11400	3475
	60	10000	3300	9550	3150	8850	2900	8400	2750	12000	3550	12000	3550	11150	3375	10550	3200
525x75	10	12000	3950	12000	3950	12000	3950	12000	3950	12000	3950	12000	3950	12000	3950	12000	3950
	20	12000	3950	12000	3950	12000	3950	12000	3950	12000	3950	12000	3950	12000	3950	12000	3950
	40	12000	3950	12000	3950	11400	3750	10900	3550	12000	3950	12000	3950	12000	3950	12000	3950
	60	11900	3925	11400	3750	10650	3500	10100	3325	12000	3950	12000	3950	12000	3950	12000	3875

NOTES:

- Sizes in italics are SmartLVL 14
- D = member depth, B = member breadth, NS = not suitable.
- The above table was based on a batten spacing of 900 mm
- Maximum birdsmouth depth = 30 % of rafter depth
- End bearing lengths = 35 mm at end supports and 35 mm at internal supports for continuous members. Subscript values indicate the minimum additional bearing length where required to be greater than 35 mm at end supports and 35 mm at internal supports
- Construction loads shall not be applied to overhangs until a 190 x 19 (minimum) timber fascia or other fascia of equivalent stiffness is rigidly and permanently attached to the end of rafter overhangs
- Rafter spacing up to 1200 mm
- Not all sizes of SmartLVL in this table are stocked in each state. Please check with your supplier before ordering.

Single/continuous span roof rafter - without ceiling attached

AS 4055 classification C1, C2 and C3

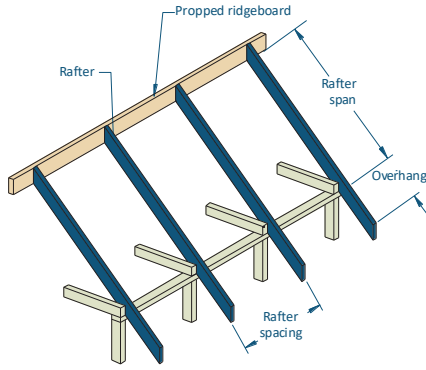

Maximum Birds-mouth = 30% of rafter dept

EXAMPLE:

wind speed = C3
 sheet roof - 40 kg/m²
 rafter/truss spacing = 600 mm
 rafter span = 5800 mm
 Enter span table at rafter spacing of 600 mm, and read down to a span equal to or greater than 5800 mm

ADOPT:

SmartLVL 14 - 240x35

Rafter spacing (mm)		450		600		900		1200		450		600		900		1200	
Member size	Roof mass	span	O/H	span	O/H	span	O/H	span	O/H	span	O/H	span	O/H	span	O/H	span	O/H
DxB (mm)	(kg/m ²)	Maximum recommended single span (mm)								Maximum recommended continuous span (mm)							
90x35	10	2200	550	2150	525	2100	450	1800	375	2700	550	2700	525	2100	450	1800	375
	20	2200	550	2150	525	2100	475	1800	400	2700	550	2700	525	2150	475	1800	400
	40	2200	550	2150	525	2100	475	1850	400	2700	550	2700	525	2200	475	1850	400
	60	2200	550	2150	525	1900	475	1750	425	2700	550	2700	525	2250	475	1900	425
120x35	10	3300	700	3250	650	2800	575	2350	475	4150	700	3600	650	2800	575	2350	475
	20	3300	700	3250	650	2850	600	2350	500	4150	700	3600	650	2850	600	2350	500
	40	3300	700	3250	650	2900	600	2400	525	4150	700	3700	650	2900	600	2400	525
	60	3150	700	2900	650	2550	600	2300	550	4150	700	3750	650	3000	600	2450	550
130x35	10	3700	750	3650	700	3050	625	2500	525	4500	750	3850	700	3050	625	2500	525
	20	3700	750	3650	700	3100	625	2550	525	4550	750	3900	700	3100	625	2550	525
	40	3700	750	3550	700	3100	625	2600	550	4650	750	4000	700	3150	625	2600	550
	60	3400	750	3100	700	2750	625	2500	575	4600	750	4050	700	3200	625	2650	575
140x35	10	4100	800	4050	750	3300	650	2700	550	4850	800	4150	750	3300	650	2700	550
	20	4100	800	4050	750	3300	675	2750	550	4900	800	4200	750	3300	675	2750	550
	40	4100	800	3800	750	3350	675	2800	575	5000	800	4250	750	3400	675	2800	575
	60	3650	800	3350	750	2950	675	2700	600	4950	800	4350	750	3450	675	2900	600
150x35	10	4550	850	4400	775	3500	700	2900	575	5150	850	4400	775	3500	700	2900	575
	20	4550	850	4400	775	3550	700	2950	575	5200	850	4450	775	3550	700	2950	575
	40	4400	850	4050	775	3600	700	3000	600	5300	850	4550	775	3600	700	3000	600
	60	3900	850	3600	775	3150	700	2900	650	5300	850	4650	775	3700	700	3100	650
170x35	10	5200	925	4850	850	3950	775	3300	625	5800	925	4950	850	3950	775	3300	625
	20	5200	925	4850	850	4000	775	3350	650	5850	925	5000	850	4000	775	3350	650
	40	4950	925	4550	850	4050	775	3400	675	5950	925	5100	850	4050	775	3400	675
	60	4400	925	4050	850	3550	775	3250	700	6000	925	5200	850	4150	775	3500	700
190x35	10	5650	1000	5300	925	4400	825	3700	700	6400	1000	5500	925	4400	825	3700	700
	20	5650	1000	5300	925	4450	850	3750	700	6500	1000	5550	925	4450	850	3750	700
	40	5500	1000	5100	925	4500	850	3800	725	6600	1000	5650	925	4500	850	3800	725
	60	4900	1000	4500	925	4000	850	3650	775	6500	1000	5800	925	4600	850	3900 ₅	775
200x35	10	5900	1050	5500	975	4600	875	3900	725	6750	1050	5750	975	4600	875	3900	725
	20	5900	1050	5500	975	4650	875	3900	725	6800	1050	5800	975	4650	875	3900	725
	40	5800	1050	5350	975	4750	875	4000	775	6950	1050	5950	975	4750	875	4000 ₅	775
	60	5150	1050	4750	975	4200	875	3850	800	6750	1050	6050	975	4850 ₅	875	4100 ₁₀	800
240x35	10	6750	1200	6300	1100	5450	1000	4650	825	7950	1200	6850	1100	5450	1000	4650 ₅	825
	20	6750	1200	6300	1100	5500	1000	4700	850	8050	1200	6900	1100	5500 ₅	1000	4700 ₁₀	850
	40	6650	1200	6250	1100	5650	1000	4800	900	8200	1200	7050	1100	5650 ₁₀	1000	4800 ₁₅	900
	60	6100	1175	5650	1100	5000	1000	4600	925	7700	1175	7200 ₅	1100	5750 ₁₅	1000	4900 ₂₀	925
90x42	10	2500	600	2400	500	2400	400	2200	350	3100	600	3100	500	2600	400	2200	350
	20	2500	600	2400	500	2400	400	2200	350	3100	600	3100	500	2600	400	2200	350
	40	2500	650	2400	550	2300	400	2100	350	3100	650	3100	550	2700	400	2200	350
	60	2500	650	2300	550	2100	450	1900	350	3100	650	3100	550	2700	450	2300	350
120x42	10	3800	750	3700	650	3200	500	2900	450	4700	750	4400	650	3500	500	2900	450
	20	3800	800	3700	650	3200	500	2900	450	4700	800	4400	650	3500	500	2900	450
	40	3800	800	3500	650	3100	550	2800	450	4700	800	4500	650	3600	550	3000	450
	60	3400	800	3100	700	2700	550	2500	450	4600	800	4200	700	3600	550	3000	450

Single/continuous span roof rafter - without ceiling attached AS 4055 classification C1, C2 and C3 (Cont'd)

Rafter spacing (mm)		450		600		900		1200		450		600		900		1200	
Member size DxB (mm)	Roof mass (kg/m ²)	span	O/H	span	O/H	span	O/H	span	O/H	span	O/H	span	O/H	span	O/H	span	O/H
		Maximum recommended single span (mm)								Maximum recommended continuous span (mm)							
130x42	10	4200	800	4000	700	3500	550	3100	450	5300	800	4700	700	3700	550	3100	450
	20	4200	850	4000	700	3500	550	3200	450	5300	850	4700	700	3800	550	3200	450
	40	4100	850	3800	700	3400	550	3100	500	5300	850	4800	700	3800	550	3200	500
	60	3700	850	3400	750	3000	600	2700	500	5000	850	4600	750	3900	600	3300	500
140x42	10	4700	850	4300	750	3800	600	3400	500	5900	850	5000	750	4000	600	3400	500
	20	4700	900	4300	750	3800	600	3400	500	5900	900	5100	750	4000	600	3400	500
	40	4500	900	4100	750	3600	600	3300	500	6000	900	5200	750	4100	600	3500	500
	60	4000	900	3600	800	3200	600	2900	500	5400	900	4900	800	4200	600	3500	500
150x42	10	5100	900	4700	800	4100	600	3600	500	6300	900	5400	800	4300	600	3600	500
	20	5100	950	4700	800	4100	650	3600	550	6300	950	5400	800	4300	650	3600	550
	40	4800	950	4400	800	3900	650	3600	550	6300	950	5500	800	4400	650	3700	550
	60	4200	950	3900	800	3400	650	3100	550	5800	950	5300	800	4500	650	3800	550
170x42	10	5800	1000	5300	850	4600	700	4100	600	7000	1000	6000	850	4800	700	4100	600
	20	5800	1000	5300	850	4600	700	4100	600	7100	1000	6100	850	4900	700	4100	600
	40	5300	1050	4900	900	4400	700	4000	600	6900	1050	6200	900	5000	700	4200	600
	60	4800	1050	4400	900	3900	700	3500	600	6400	1050	6000	900	5100	700	4300	600
190x42	10	6500	1100	5900	950	5200	750	4500	650	7800	1100	6700	950	5400	750	4500	650
	20	6500	1100	5900	950	5200	750	4600	650	7900	1100	6700	950	5400	750	4600	650
	40	5900	1150	5500	1000	4900	750	4500	650	7500	1150	6900	1000	5500	750	4700	650
	60	5300	1150	4900	1000	4300	800	4000	650	6900	1150	6500	1000	5600	800	4800	650
200x42	10	6800	1150	6200	1000	5400	800	4800	650	8200	1150	7000	1000	5600	800	4800	650
	20	6800	1150	6200	1000	5400	800	4800	650	8200	1150	7100	1000	5700	800	4800	650
	40	6200	1200	5800	1000	5100	800	4700	700	7800	1200	7200	1000	5800	800	4900	700
	60	5600	1200	5100	1050	4500	800	4200	700	7100	1200	6700	1050	5900	800	5000	700
240x42	10	8200	1350	7500	1150	6500	900	5700	750	9700	1350	8300	1150	6700	900	5700	750
	20	7800	1350	7500	1150	6500	900	5700	750	9800	1350	8400	1150	6700	900	5700	750
	40	7000	1400	6600	1150	6100	950	5600	800	8800	1400	8300	1150	6900	950	5800	800
	60	6500	1400	6100	1200	5400	950	5000	800	8100	1400	7600	1200	7000	950	5900 ₅	800
300x42	10	9800	1600	9300	1350	8100	1050	7000	900	11900	1600	10200	1350	8200	1050	7000 ₅	900
	20	9100	1600	8700	1400	8100	1100	7100	900	11400	1600	10300	1400	8300	1100	7100 ₁₀	900
	40	8100	1650	7700	1400	7100	1100	6700	950	10200	1650	9700	1400	8400 ₅	1100	7200 ₁₅	950
	60	7600	1700	7100	1450	6500	1150	6100	950	9500	1700	8900	1450	8200 ₁₀	1150	7300 ₂₀	950
90x58	10	2900	750	2900	600	2700	500	2400	400	3600	750	3600	600	3100	500	2600	400
	20	2900	750	2900	650	2700	500	2400	400	3600	750	3600	650	3100	500	2600	400
	40	2900	750	2900	650	2600	500	2400	450	3600	750	3600	650	3200	500	2700	450
	60	2800	750	2600	650	2300	500	2100	450	3600	750	3500	650	3100	500	2700	450
130x58	10	4900	1000	4500	850	3900	650	3600	550	6300	1000	5600	850	4400	650	3700	550
	20	4900	1000	4500	850	3900	650	3600	550	6300	1000	5600	850	4500	650	3800	550
	40	4500	1000	4200	850	3700	700	3400	600	6100	1000	5700	850	4600	700	3800	600
	60	4100	1000	3700	900	3300	700	3000	600	5500	1000	5100	900	4500	700	3900	600
150x58	10	5700	1100	5200	950	4500	750	4100	650	7400	1100	6300	950	5100	750	4300	650
	20	5700	1100	5200	950	4500	750	4100	650	7500	1100	6400	950	5100	750	4300	650
	40	5200	1150	4800	950	4300	750	3900	650	6800	1150	6400	950	5200	750	4400	650
	60	4600	1150	4300	1000	3800	800	3500	650	6200	1150	5800	1000	5200	800	4500	650
170x58	10	6500	1200	5900	1050	5100	850	4700	700	8300	1200	7100	1050	5700	850	4800	700
	20	6500	1200	5900	1050	5100	850	4700	700	8300	1200	7200	1050	5800	850	4900	700
	40	5800	1250	5400	1050	4800	850	4400	700	7400	1250	7000	1050	5900	850	5000	700
	60	5200	1300	4800	1100	4300	850	3900	750	6800	1300	6400	1100	5800	850	5100	750
200x58	10	7600	1400	6900	1200	6000	950	5500	800	9700	1400	8300	1200	6700	950	5700	800
	20	7300	1400	6900	1200	6000	950	5500	800	9200	1400	8400	1200	6700	950	5700	800
	40	6500	1450	6200	1200	5600	950	5200	800	8200	1450	7800	1200	6800	950	5800	800
	60	6100	1450	5600	1250	5000	1000	4600	850	7600	1450	7200	1250	6600	1000	5900	850

Single/continuous span roof rafter - without ceiling attached AS 4055 classification C1, C2 and C3 (Cont'd)

Rafter spacing (mm)		450		600		900		1200		450		600		900		1200	
Member size DxB (mm)	Roof mass (kg/m ²)	span	O/H	span	O/H	span	O/H	span	O/H	span	O/H	span	O/H	span	O/H	span	O/H
		Maximum recommended single span (mm)								Maximum recommended continuous span (mm)							
240x58	10	8800	1600	8300	1350	7200	1100	6600	900	11100	1600	9800	1350	7900	1100	6700	900
	20	8200	1650	7900	1400	7200	1100	6600	950	10300	1650	9900	1400	8000	1100	6800	950
	40	7400	1650	7000	1400	6500	1100	6100	950	9300	1650	8800	1400	8100	1100	6900	950
	60	6900	1700	6500	1450	6000	1150	5500	950	8700	1700	8200	1450	7500	1150	7000	950
300x58	10	10100	1950	9800	1650	9100	1300	8200	1100	12000	1950	12000	1650	9700	1300	8300	1100
	20	9400	1950	9100	1650	8600	1300	8200	1100	11900	1950	11400	1650	9800	1300	8400	1100
	40	8600	2000	8200	1700	7600	1350	7200	1150	10800	2000	10300	1700	9600	1350	8500 ₅	1150
	60	8000	2050	7600	1750	7000	1350	6600	1150	10100	2050	9500	1750	8800	1350	8300 ₁₀	1150
360x58	10	11200	2250	10900	1900	10500	1500	9700	1250	12000	2250	12000	1900	11300	1500	9700 ₅	1250
	20	10500	2300	10200	1950	9600	1500	9200	1300	12000	2300	12000	1950	11400 ₅	1500	9800 ₁₀	1300
	40	9700	2350	9200	2000	8600	1550	8100	1300	12000	2350	11600	2000	10800 ₅	1550	10000 ₁₅	1300
	60	9100	2400	8600	2000	8000	1600	7500	1350	11400	2400	10800	2000	10000 ₅	1600	9400 ₂₀	1350
400x58	10	11800	2500	11600	2100	11200	1650	10600	1350	12000	2500	12000	2100	12000 ₅	1650	10600 ₁₅	1350
	20	11200	2500	10900	2100	10300	1650	9900	1400	12000	2500	12000	2100	12000 ₅	1650	10700 ₁₅	1400
	40	10300	2550	9900	2150	9200	1700	8800	1400	12000	2550	12000	2150	11600 ₁₀	1700	10900 ₂₅	1400
	60	9700	2600	9200	2200	8600	1750	8100	1450	12000	2600	11600	2200	10800 ₁₀	1750	10200 ₂₅	1450
450x58	10	12000	2750	12000	2300	12000	1800	11700	1500	12000	2750	12000	2300	12000 ₅	1800	11700 ₂₀	1500
	20	12000	2750	11700	2350	11100	1800	10700	1550	12000	2750	12000	2350	12000 ₅	1800	11800 ₂₅	1550
	40	11100	2800	10700	2400	10000	1850	9500	1550	12000	2800	12000	2400	12000 ₁₀	1850	12000 ₃₀	1550
	60	10500	2900	10000	2450	9300	1900	8800	1600	12000	2900	12000	2450	11700 ₁₅	1900	11000 ₃₀	1600
240x75	10	<i>8150</i>	<i>2150</i>	<i>7600</i>	<i>2150</i>	<i>6850</i>	<i>1750</i>	<i>6400</i>	<i>1475</i>	<i>10300</i>	<i>2150</i>	<i>9550</i>	<i>2150</i>	<i>7800</i>	<i>1750</i>	<i>6650</i>	<i>1475</i>
	20	<i>8150</i>	<i>2150</i>	<i>7600</i>	<i>2150</i>	<i>6850</i>	<i>1775</i>	<i>6400</i>	<i>1500</i>	<i>10300</i>	<i>2150</i>	<i>9550</i>	<i>2150</i>	<i>7900</i>	<i>1775</i>	<i>6700</i>	<i>1500</i>
	40	<i>7600</i>	<i>2150</i>	<i>7250</i>	<i>2150</i>	<i>6750</i>	<i>1850</i>	<i>6350</i>	<i>1550</i>	<i>9550</i>	<i>2150</i>	<i>9100</i>	<i>2150</i>	<i>8050</i>	<i>1850</i>	<i>6850</i>	<i>1550</i>
	60	<i>7100</i>	<i>2150</i>	<i>6750</i>	<i>2150</i>	<i>6200</i>	<i>1925</i>	<i>5750</i>	<i>1625</i>	<i>8950</i>	<i>2150</i>	<i>8450</i>	<i>2150</i>	<i>7800</i>	<i>1925</i>	<i>7000</i>	<i>1625</i>
300x75	10	<i>9650</i>	<i>2675</i>	<i>9000</i>	<i>2650</i>	<i>8100</i>	<i>2100</i>	<i>7550</i>	<i>1775</i>	<i>12000</i>	<i>2675</i>	<i>11300</i>	<i>2650</i>	<i>9600</i>	<i>2100</i>	<i>8200</i>	<i>1775</i>
	20	<i>9600</i>	<i>2675</i>	<i>9000</i>	<i>2675</i>	<i>8100</i>	<i>2125</i>	<i>7550</i>	<i>1800</i>	<i>12000</i>	<i>2675</i>	<i>11300</i>	<i>2675</i>	<i>9700</i>	<i>2125</i>	<i>8300</i>	<i>1800</i>
	40	<i>8800</i>	<i>2675</i>	<i>8400</i>	<i>2675</i>	<i>7850</i>	<i>2225</i>	<i>7450</i>	<i>1875</i>	<i>11050</i>	<i>2675</i>	<i>10600</i>	<i>2675</i>	<i>9850</i>	<i>2225</i>	<i>8450₅</i>	<i>1875</i>
	60	<i>8250</i>	<i>2675</i>	<i>7850</i>	<i>2550</i>	<i>7250</i>	<i>2300</i>	<i>6850</i>	<i>1950</i>	<i>10400</i>	<i>2675</i>	<i>9850</i>	<i>2675</i>	<i>9100</i>	<i>2300</i>	<i>8600₁₀</i>	<i>1950</i>
400x75	10	<i>11950</i>	<i>3550</i>	<i>11150</i>	<i>3400</i>	<i>10100</i>	<i>2675</i>	<i>9400</i>	<i>2250</i>	<i>12000</i>	<i>3550</i>	<i>12000</i>	<i>3400</i>	<i>12000₅</i>	<i>2675</i>	<i>10500₁₀</i>	<i>2250</i>
	20	<i>11400</i>	<i>3550</i>	<i>11050</i>	<i>3475</i>	<i>10100</i>	<i>2725</i>	<i>9400</i>	<i>2300</i>	<i>12000</i>	<i>3550</i>	<i>12000</i>	<i>3475</i>	<i>12000₅</i>	<i>2725</i>	<i>10600₁₅</i>	<i>2300</i>
	40	<i>10550</i>	<i>3475</i>	<i>10150</i>	<i>3300</i>	<i>9550</i>	<i>2825</i>	<i>9050</i>	<i>2375</i>	<i>12000</i>	<i>3550</i>	<i>12000</i>	<i>3550</i>	<i>12000₁₀</i>	<i>2825</i>	<i>10800₂₀</i>	<i>2375</i>
	60	<i>10000</i>	<i>3300</i>	<i>9550</i>	<i>3150</i>	<i>8850</i>	<i>2900</i>	<i>8400</i>	<i>2475</i>	<i>12000</i>	<i>3550</i>	<i>12000</i>	<i>3550</i>	<i>11150₁₀</i>	<i>2950</i>	<i>10550₂₅</i>	<i>2475</i>
525x75	10	<i>12000</i>	<i>3950</i>	<i>12000</i>	<i>3950</i>	<i>12000</i>	<i>3375</i>	<i>11500</i>	<i>2825</i>	<i>12000</i>	<i>3950</i>	<i>12000</i>	<i>3950</i>	<i>12000₅</i>	<i>3375</i>	<i>12000₂₅</i>	<i>2825</i>
	20	<i>12000</i>	<i>3950</i>	<i>12000</i>	<i>3950</i>	<i>12000</i>	<i>3425</i>	<i>11500</i>	<i>2875</i>	<i>12000</i>	<i>3950</i>	<i>12000</i>	<i>3950</i>	<i>12000₅</i>	<i>3425</i>	<i>12000₂₅</i>	<i>2875</i>
	40	<i>12000</i>	<i>3950</i>	<i>12000</i>	<i>3950</i>	<i>11400</i>	<i>3575</i>	<i>10900</i>	<i>3000</i>	<i>12000</i>	<i>3950</i>	<i>12000</i>	<i>3950</i>	<i>12000₁₀</i>	<i>3575</i>	<i>12000₃₀</i>	<i>3000</i>
	60	<i>11900</i>	<i>3925</i>	<i>11400</i>	<i>3750</i>	<i>10650</i>	<i>3500</i>	<i>10100</i>	<i>3125</i>	<i>12000</i>	<i>3950</i>	<i>12000</i>	<i>3950</i>	<i>12000₁₅</i>	<i>3725</i>	<i>12000₃₅</i>	<i>3125</i>

NOTES:

- Sizes in italics are SmartLVL 14
- D = member depth, B = member breadth, NS = not suitable.
- The above table was based on a batten spacing of 900 mm
- Maximum birdsmouth depth = 30 % of rafter depth
- End bearing lengths = 35 mm at end supports and 35 mm at internal supports for continuous members. Subscript values indicate the minimum additional bearing length where required to be greater than 35 mm at end supports and 35 mm at internal supports
- Construction loads shall not be applied to overhangs until a 190 x 19 (minimum) timber fascia or other fascia of equivalent stiffness is rigidly and permanently attached to the end of rafter overhangs
- Max rafter spacing up to 1200 mm
- Not all sizes of SmartLVL in this table are stocked in each state. Please check with your supplier before ordering

Single span ridge/intermediate roof beam AS 4055 classification N1, N2 and N3

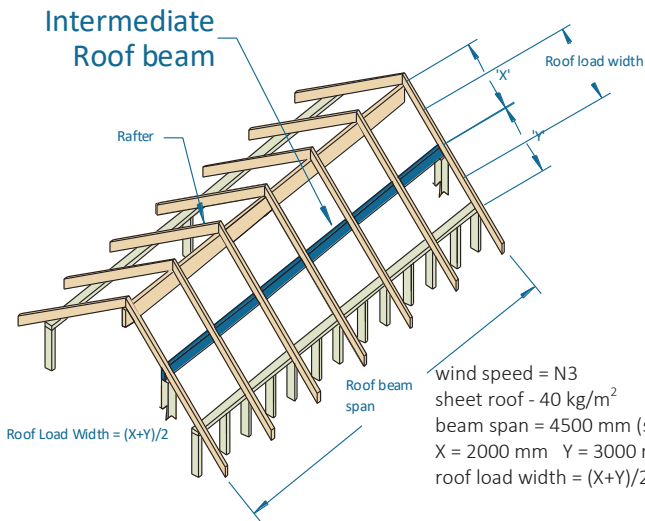

Roof Load Width = $(X+Y)/2$

EXAMPLE:
 wind speed = N3
 sheet roof - 40 kg/m²
 beam span = 4500 mm (single span)
 X = 2000 mm Y = 3000 mm
 roof load width = $(X+Y)/2 = 2500$ mm

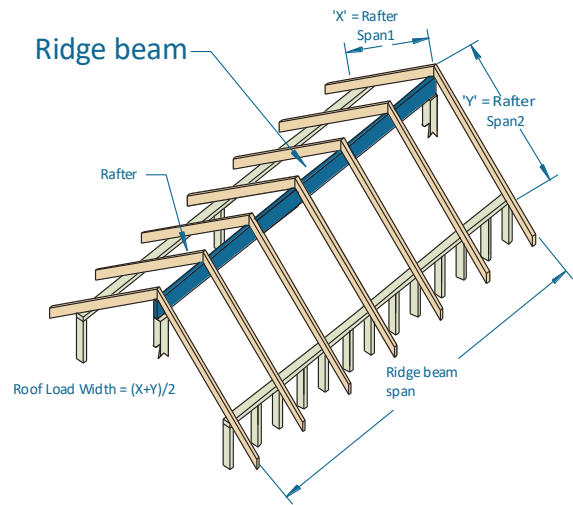

Roof Load Width = $(X+Y)/2$

Enter single span table at 3000 roof load width with column and read down to span equal to or greater than 4500 mm

ADOPT:

SmartLVL 14 - 300x35

Roof load width (mm)		1500		3000		4500		6000		7500	
Member size DxB (mm)	Roof mass (kg/m ²)	span	O/H	span	O/H	span	O/H	span	O/H	span	O/H
Maximum recommended Ridge or Intermediate roof beam span - Single span (mm)											
150x35	40	3000	950	2350	775	2000	650	1800	550	1600	525
	90	2350	775	1850	600	1600	525	1400	450	1300	425
170x35	40	3400	1100	2650	850	2250	700	2000	650	1850	600
	90	2650	850	2050	675	1800	550	1600	525	1500	450
190x35	40	3750	1225	2950	950	2550	800	2250	700	2050	675
	90	2950	950	2300	750	2000	650	1800	550	1650	500
200x35	40	3950	1300	3100	1000	2650	850	2400	750	2150	700
	90	3100	1000	2450	800	2100	650	1900	625	1750 ₅	575 ₅
240x35	40	4750	1550	3700	1200	3200	1050	2850	900	2600	850
	90	3700	1200	2950	950	2550	800	2300 ₅	750 ₅	2100 ₁₀	650 ₁₀
300x35	40	5900	1900	4650	1525	4000	1300	3550	1150	3200	1050
	90	4600	1500	3650	1200	3150 ₅	1000 ₅	2850 ₁₅	900 ₁₅	2600 ₃₀	850 ₃₀
2/150x35	40	3700	1200	2900	950	2500	825	2250	700	2050	675
	90	2900	950	2300	750	2000	650	1800	550	1650	500
2/170x35	40	4200	1375	3300	1050	2850	900	2550	800	2300	750
	90	3300	1050	2600	850	2250	700	2050	675	1850	600
2/190x35	40	4650	1525	3700	1200	3150	1000	2850	900	2600	850
	90	3700	1200	2900	950	2550	800	2250	700	2100	650
2/200x35	40	4900	1600	3900	1275	3350	1100	3000	950	2700	850
	90	3850	1250	3050	1000	2650	850	2400	750	2200	725
2/240x35	40	5850	1925	4650	1525	4000	1300	3550	1150	3250	1050
	90	4600	1500	3650	1200	3200	1050	2850	900	2650	850
2/300x35	40	6900	2275	5750	1850	5000	1650	4450	1450	4050	1325
	90	5750	1850	4600	1500	4000	1300	3600	1150	3300	1050
150x42	40	3200	1200	2500	1200	2200	1100	1900	900	1700	800
150x42	90	2500	1200	2000	1000	1700	800	1500	700	1400	700
170x42	40	3700	1400	2900	1400	2500	1250	2200	1100	2000	1000
170x42	90	2900	1400	2200	1100	1900	900	1700	800	1600	800

Single span ridge/intermediate roof beam AS 4055 classification N1, N2 and N3 [Cont'd]

Roof load width (mm)		1500		3000		4500		6000		7500	
Member size DxB (mm)	Roof mass (kg/m ²)	span	O/H	span	O/H	span	O/H	span	O/H	span	O/H
Maximum recommended Ridge or Intermediate roof beam - Single span (mm)											
190x42	40	4100	1550	3200	1550	2700	1300	2400	1200	2200	1100
	90	3200	1550	2500	1200	2200	1100	1900	900	1800 ₅	900 ₅
	200x42	40	4300	1600	3400	1600	2900	1450	2600	1250	2300
240x42	90	3400	1600	2600	1300	2300	1100	2100	1000	1900 ₅	900 ₅
	40	5100	1950	4000	1950	3500	1700	3100	1500	2800	1350
300x42	90	4000	1950	3200	1600	2800	1400	2500 ₅	1200 ₅	2300 ₁₀	1100 ₁₀
	40	6400	2400	5100	2350	4300	2100	3900	1800	3500 ₅	1650
	90	5000	2400	4000	2000	3400 ₅	1700 ₅	3100 ₁₅	1500 ₁₅	2800 ₂₅	1400 ₂₅
2/150x42	40	4000	1550	3200	1550	2700	1300	2400	1200	2200	1100
	90	3200	1550	2500	1200	2200	1100	1900	900	1800	900
2/170x42	40	4500	1700	3600	1700	3100	1500	2800	1400	2500	1200
	90	3600	1700	2800	1400	2400	1200	2200	1100	2000	1000
2/190x42	40	5000	1900	4000	1900	3400	1700	3100	1500	2800	1400
	90	4000	1900	3200	1600	2700	1300	2500	1200	2300	1100
2/200x42	40	5300	2000	4200	2000	3600	1800	3200	1600	3000	1500
	90	4200	2000	3300	1600	2900	1400	2600	1300	2400	1200
2/240x42	40	6300	2400	5000	2350	4300	2100	3900	1900	3500	1700
	90	5000	2400	4000	2000	3500	1700	3100	1500	2900	1400
2/300x42	40	7800	3000	6300	2750	5400	2500	4900	2300	4400	2150
	90	6200	2850	5000	2400	4300	2150	3900	1900	3600 ₅	1800 ₅
2/360x42	40	9200	3600	7500	3200	6500	2850	5800	2650	5300	2450
	90	7400	3300	6000	2750	5200	2500	4700 ₅	2300 ₅	4300 ₁₀	2150 ₁₀
2/400x42	40	10200	4000	8300	3450	7200	3100	6400	2850	5900	2650
	90	8200	3550	6600	3000	5800	2700	5200 ₁₀	2500 ₁₀	4800 ₁₅	2350 ₁₅
150x58	40	3600	1350	2800	1350	2400	1200	2100	1000	1900	900
	90	2800	1350	2200	1100	1900	900	1700	800	1600	800
170x58	40	4100	1550	3200	1550	2700	1300	2400	1200	2200	1100
	90	3200	1550	2500	1200	2200	1100	1900	900	1800	900
200x58	40	4800	1800	3700	1800	3200	1600	2900	1400	2600	1300
	90	3700	1800	2900	1400	2500	1200	2300	1100	2100	1000
240x58	40	5700	2150	4500	2150	3900	1900	3400	1700	3100	1550
	90	4500	2150	3500	1700	3100	1500	2800	1400	2500 ₅	1200 ₅
300x58	40	7000	2650	5600	2550	4800	2250	4300	2050	3900	1900
	90	5600	2600	4400	2200	3800	1900	3500 ₅	1700 ₅	3200 ₁₀	1600 ₁₀
360x58	40	8300	3200	6700	2900	5800	2600	5200	2400	4700 ₅	2250
	90	6700	3000	5300	2500	4600 ₅	2250 ₅	4100 ₁₅	2000 ₁₅	3800 ₂₀	1900 ₂₀
400x58	40	9200	3550	7400	3150	6400	2850	5700 ₅	2600	5200 ₁₀	2400 ₁₀
	90	7400	3250	5900	2750	5100 ₁₀	2450 ₁₀	4600 ₂₀	2250 ₂₀	4200 ₃₀	2100 ₃₀
450x58	40	10300	4000	8300	3450	7200	3100	6400 ₁₀	2850	5900 ₁₅	2650 ₁₅
	90	8300	3550	6600 ₅	3000 ₅	5800 ₁₅	2700 ₁₅	5200 ₂₅	2500 ₂₅	4800 ₃₅	2350 ₃₅
300x75	40	7000	2300	5900	1900	5100	1675	4550	1500	4150	1350
	90	5850	1925	4700	1550	4050	1325	3650	1200	3400	1100
400x75	40	8550	2800	7300	2400	6550	2150	6050	1950	5550	1825
	90	7250	2350	6150	2025	5400	1775	4900 ₅	1600 ₅	4500 ₁₀	1475 ₁₀
525x75	40	10350	3400	8850	2900	8000	2600	7350	2425	6900 ₅	2275 ₅
	90	8850	2900	7500	2475	6800 ₅	2200 ₅	6300 ₂₀	2075 ₂₀	5900 ₄₀	1900 ₄₀
300x82	40	7200	3000	6100	2750	5400	2450	4800	2250	4400	2050
	90	6100	2800	4900	2400	4300	2150	3800	1900	3500 ₅	1700 ₅
400x82	40	8800	3950	7600	3450	6800	3100	6300	2850	5800	2650
	90	7500	2500	6400	2950	5700	2650	5100 ₁₀	2450 ₁₀	4700 ₁₅	2300 ₁₅

NOTES:

- Sizes in *italics* are SmartLVL 14
- D = member depth, B = member breadth, NS = not suitable.
- End bearing lengths = 35 mm at end supports and 70 mm at internal supports for continuous members. Subscript values indicate the minimum additional bearing length where required to be greater than 35 mm at end supports and 70 mm at internal supports
- Max rafter spacing up to 1200 mm
- Not all sizes of SmartLVL in this table are stocked in each state. check with your supplier before ordering. WA only

Continuous span ridge/intermediate roof beam AS 4055 classification N1, N2 and N3

Roof load width (mm)		1500		3000		4500		6000		7500	
Member size DxH (mm)	Roof mass (kg/m ²)	span	O/H	span	O/H	span	O/H	span	O/H	span	O/H
		Maximum Ridge or Intermediate roof beam - Continuous span (mm)									
150x35	40	4050	1075	2750	900	2250	700	1900	625	1700	550
	90	3150	1000	2450	800	1950	600	1700	550	1500 ₁₀	450 ₁₀
170x35	40	4600	1200	3100	1000	2500	825	2150	700	1900 ₁₀	625
	90	3600	1150	2700	850	2200	725	1900 ₁₀	625 ₁₀	1700 ₂₀	550 ₂₀
190x35	40	5100	1325	3400	1100	2750	900	2400 ₁₀	750	2100 ₂₀	650
	90	4000	1300	3000	950	2450 ₅	800	2100 ₂₀	650 ₂₀	1850 ₅	600 ₅
200x35	40	5400	1400	3600	1150	2900	950	2500 ₁₀	825	2200 ₂₅	725
	90	4200	1375	3150	1000	2550 ₁₀	800	2200 ₂₅	725 ₂₅	1950 ₅	600 ₅
240x35	40	6300	1675	4200	1375	3400 ₁₀	1100	2950	950	2600 ₅	850 ₅
	90	5050	1600	3700 ₅	1200	3000 ₂₅	950 ₂₅	2600 ₅	850 ₅	2300 ₁₀	750 ₁₀
2/150x35	40	5050	1325	3950	1300	3400	1100	2900	950	2550	800
	90	3950	1300	3150	1000	2700	850	2450	800	2250	700
2/170x35	40	5700	1500	4500	1475	3800	1250	3250	1050	2900	950
	90	4450	1450	3550	1150	3050	1000	2750	900	2550	800
2/190x35	40	6250	1675	5000	1625	4200	1375	3600	1150	3200	1050
	90	5000	1600	3950	1300	3450	1100	3100	1000	2800 ₅	900
2/200x35	40	6500	1750	5250	1675	4350	1425	3750	1225	3350	1100
	90	5250	1650	4150	1350	3600	1150	3250	1050	2950 ₁₀	950
2/240x35	40	7400	2100	6200	1900	5150	1650	4400	1450	3950 ₁₅	1300
	90	6200	1900	5000	1600	4300	1400	3900 ₁₅	1275	3450 ₂₅	1100
2/300x35	40	8650	2625	7300	2250	6300 ₅	2000	5400 ₂₀	1775	4800 ₅	1575
	90	7300	2225	6150	1875	5400 ₁₅	1700	4750 ₅	1550	4250 ₁₀	1400 ₁₀
150x42	40	4400	1200	3400	1200	2900	1100	2600	1000	2400	900
	90	3400	1200	2700	1150	2300	1050	2100	950	1800 ₁₀	900 ₁₀
170x42	40	5000	1400	3900	1400	3300	1250	3000	1100	2700	1000
	90	3900	1400	3100	1300	2600	1150	2300 ₁₀	1050	2100 ₂₅	1000 ₂₅
190x42	40	5600	1550	4400	1550	3700	1400	3300	1200	3000	1100
	90	4400	1550	3400	1400	3000	1250	2600 ₂₀	1150 ₂₀	2300 ₃₅	1100 ₃₅
200x42	40	5800	1600	4600	1600	3900	1450	3500	1250	3200	1150
	90	4600	1600	3600	1450	3100 ₅	1300	2700 ₂₅	1200 ₂₅	2400 ₄₀	1150 ₄₀
240x42	40	7000	1950	5500	1950	4700	1700	4200	1500	3800 ₂₀	1350
	90	5500	1950	4300	1700	3800 ₂₅	1500 ₂₅	3200 ₄₅	1400 ₄₅	2800 ₆₅	1300 ₆₅
300x42	40	8700	2400	6900	2350	5900	2100	5300 ₂₅	1800	4800 ₄₅	1650
	90	6800	2400	5400 ₂₀	2000	4600 ₅₀	1800 ₅₀	3900 ₈₀	1650 ₈₀	3500 ₁₀₀	1550 ₁₀₀
2/150x42	40	5500	1550	4300	1550	3700	1400	3300	1300	3000	1200
	90	4300	1550	3400	1400	2900	1250	2600	1150	2400	1100
2/170x42	40	6200	1700	4900	1700	4200	1600	3800	1450	3400	1350
	90	4900	1700	3900	1550	3300	1400	3000	1250	2800	1200
2/190x42	40	6900	1900	5400	1900	4700	1700	4200	1600	3800	1500
	90	5400	1900	4300	1700	3700	1500	3400	1400	3100	1300
2/200x42	40	7200	2000	5700	2000	4900	1800	4400	1650	4000	1550
	90	5700	2000	4500	1750	3900	1550	3500	1450	3300	1350
2/240x42	40	8600	2400	6800	2350	5900	2100	5300	1900	4800	1800
	90	6800	2400	5400	2000	4700	1800	4300	1650	3900 ₁₅	1550
2/300x42	40	10600	3000	8500	2750	7400	2500	6600	2300	6000	2150
	90	8500	2850	6800	2400	5900	2150	5300 ₂₅	2000	4900 ₄₅	1850 ₄₅
2/360x42	40	12000	3600	10100	3200	8800	2850	7900	2650	7200 ₁₅	2450
	90	10100	3300	8100	2750	7100 ₂₀	2500	6400 ₄₅	2300 ₄₅	5900 ₇₅	2150 ₇₅
2/400x42	40	12000	4000	11200	3450	9700	3100	8700 ₁₀	2850	8000 ₃₀	2650
	90	11200	3550	9000 ₅	3000	7800 ₃₅	2700 ₃₅	7100 ₆₅	2500 ₆₅	6500 ₉₅	2350 ₉₅

Continuous span ridge/intermediate roof beam AS 4055 classification N1, N2 and N3 [Cont'd]

Roof load width (mm)		1500		3000		4500		6000		7500	
Member size DxB (mm)	Roof mass (kg/m ²)	span	O/H	span	O/H	span	O/H	span	O/H	span	O/H
		Maximum Ridge or Intermediate roof beam - Continuous span (mm)									
150x58	40	4900	1350	3800	1350	3300	1300	2900	1150	2700	1050
	90	3800	1350	3000	1250	2600	1150	2300	1050	2100	1000
170x58	40	5500	1550	4300	1550	3700	1450	3300	1300	3000	1150
	90	4300	1550	3400	1400	3000	1250	2700	1150	2400 ₅	1100
200x58	40	6500	1800	5100	1800	4400	1650	3900	1500	3600	1350
	90	5100	1800	4000	1600	3500	1400	3100 ₅	1300	2800 ₂₀	1250 ₂₀
240x58	40	7700	2150	6100	2150	5300	1900	4700	1750	4300	1550
	90	6100	2150	4800	1850	4200 ₅	1650	3800 ₂₅	1500 ₂₅	3300 ₄₀	1400 ₄₀
300x58	40	9500	2650	7600	2550	6500	2250	5900 ₅	2050	5400 ₂₅	1900
	90	7600	2600	6000	2200	5200 ₂₅	1950 ₂₅	4600 ₅₀	1800 ₅₀	4100 ₇₅	1700 ₇₅
360x58	40	11300	3200	9100	2900	7800	2600	7000 ₂₀	2400	6400 ₄₅	2250
	90	9000	3000	7200 ₁₅	2500	6200 ₅₀	2250 ₅₀	5300 ₈₀	2100 ₈₀	4700 ₁₀₀	1950 ₁₀₀
400x58	40	12000	3550	10000	3150	8700 ₁₀	2850	7800 ₃₅	2600	7000 ₆₀	2400 ₆₀
	90	10000	3250	8000 ₃₀	2750 ₃₀	6800 ₆₅	2450 ₆₅	5800 ₉₅	2250 ₉₅	5100 ₁₁₅	2150 ₁₁₅
<i>240x75</i>	<i>40</i>	<i>7500</i>	<i>2150</i>	<i>6300</i>	<i>1950</i>	<i>5450</i>	<i>1750</i>	<i>4650</i>	<i>1525</i>	<i>4150</i>	<i>1350</i>
	<i>90</i>	<i>6300</i>	<i>1925</i>	<i>5100</i>	<i>1625</i>	<i>4400</i>	<i>1450</i>	<i>3800</i>	<i>1250</i>	<i>3350₅</i>	<i>1100</i>
<i>300x75</i>	<i>40</i>	<i>8800</i>	<i>2675</i>	<i>7450</i>	<i>2275</i>	<i>6650</i>	<i>2050</i>	<i>5700</i>	<i>1875</i>	<i>5050₅</i>	<i>1650</i>
	<i>90</i>	<i>7400</i>	<i>2250</i>	<i>6250</i>	<i>1900</i>	<i>5400</i>	<i>1725</i>	<i>4600₁₅</i>	<i>1500</i>	<i>4100₂₅</i>	<i>1350₂₅</i>
<i>400x75</i>	<i>40</i>	<i>10750</i>	<i>3275</i>	<i>9150</i>	<i>2800</i>	<i>8250</i>	<i>2525</i>	<i>7200₁₅</i>	<i>2325</i>	<i>6400₅</i>	<i>2100₅</i>
	<i>90</i>	<i>9150</i>	<i>2775</i>	<i>7750</i>	<i>2350</i>	<i>6800₂₀</i>	<i>2125₂₀</i>	<i>5800₅</i>	<i>1900₅</i>	<i>5150₁₀</i>	<i>1650₁₀</i>
<i>525x75</i>	<i>40</i>	<i>12000</i>	<i>3950</i>	<i>11150</i>	<i>3400</i>	<i>10050₂₀</i>	<i>3050</i>	<i>9000₅</i>	<i>2825₅</i>	<i>7950₁₀</i>	<i>2600₁₀</i>
	<i>90</i>	<i>11100</i>	<i>3375</i>	<i>9450₁₅</i>	<i>2875₁₅</i>	<i>8450₁₀</i>	<i>2600₁₀</i>	<i>7250₂₀</i>	<i>2350₂₀</i>	<i>6400₉₅</i>	<i>2100₉₅</i>
300x82	40	9100	3000	7700	2750	6900	2450	6400	2250	5900	2050
	90	7700	2800	6500	2400	5700 ₅	2150	4900 ₂₀	1950 ₂₀	4300 ₂₀	1850 ₂₀
400x82	40	11100	3950	9500	3450	8600	3100	7900 ₅	2850	7400 ₂₀	2650
	90	9500	3500	8000	2950	7200 ₂₀	2650 ₃₀	6300 ₄₅	2450 ₄₅	5600 ₇₀	2300 ₇₀

NOTES:

- Sizes in italics are SmartLVL 14
- D = member depth, B = member breadth, NS = not suitable
- End bearing lengths = 35 mm at end supports and 70 mm at internal supports for continuous members. Subscript values indicate the minimum additional bearing length where required to be greater than 35 mm at end supports and 70 mm at internal supports
- Maximum rafter spacing up to 1200 mm
- Not all sizes of SmartLVL in this table are stocked in each state. Please check with your supplier before ordering WA only

Single span ridge/intermediate roof beam AS 4055 classification C1, C2 and C3

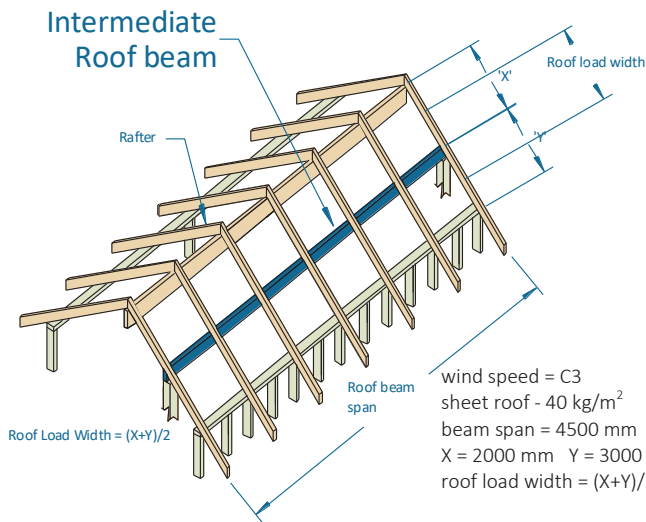

EXAMPLE:

wind speed = C3
 sheet roof - 40 kg/m²
 beam span = 4500 mm
 X = 2000 mm Y = 3000 mm
 roof load width = (X+Y)/2 = 2500 mm

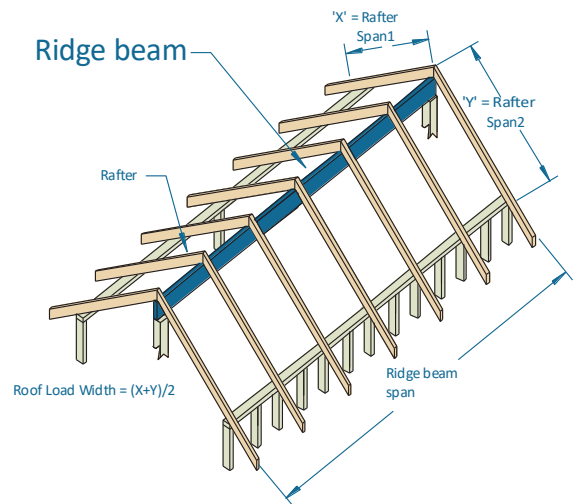

Enter single span table at 3000 roof load width with column
 And read down to span equal to or greater than 4500 mm

ADOPT:

SmartLVL 14 -2/300x35

Roof load width (mm)		1500		3000		4500		6000		7500	
Member size DxB (mm)	Roof mass (kg/m ²)	span	O/H	span	O/H	span	O/H	span	O/H	span	O/H
Maximum recommended ridge/Intermediate roof beam - Single span (mm)											
150x35	40	2650	850	1850	600	1500	450	1300	425	1200	350
	90	2350	775	1850	600	1500	450	1300	425	1150	375
170x35	40	2950	950	2100	650	1700	550	1500	450	1300	425
	90	2650	850	2050	675	1700	550	1450	475	1300	425
200x35	40	3500	1150	2400	750	2000	650	1700	550	1550	500
	90	3100	1000	2450	800	1950	600	1700	550	1500	450
240x35	40	4150	1350	2850	900	2350	775	2000	650	1800	550
	90	3700	1200	2850	900	2350	775	2000	650	1800 ₅	550 ₅
300x35	40	5200	1700	3500	1150	2850	900	2500	825	2200	725
	90	4600	1500	3500	1150	2850	900	2450 ₅	800 ₅	2200 ₁₅	725 ₁₅
2/150x35	40	3700	1200	2800	900	2300	750	2000	650	1800	550
	90	2900	950	2300	750	2000	650	1800	550	1650	500
2/170x35	40	4200	1375	3150	1000	2600	850	2250	700	2000	650
	90	3300	1050	2600	850	2250	700	2050	675	1850	600
2/190x35	40	4650	1525	3500	1150	2850	900	2500	825	2200	725
	90	3700	1200	2900	950	2550	800	2250	700	2100	650
2/200x35	40	4900	1600	3650	1200	3000	950	2600	850	2350	775
	90	3850	1250	3050	1000	2650	850	2400	750	2200	725
2/240x35	40	5850	1925	4300	1400	3550	1150	3050	1000	2750	900
	90	4600	1500	3650	1200	3200	1050	2850	900	2650	850
2/300x35	40	6900	2275	5300	1700	4300	1400	3750	1225	3350	1100
	90	5750	1850	4600	1500	4000	1300	3600	1150	3300	1050
150x42	40	3200	1200	2200	900	1800	750	1600	650	1400	550
	90	2500	1200	2000	900	1700	750	1500	650	1400 ₅	600 ₅
170x42	40	3600	1400	2500	1000	2000	800	1800	700	1600 ₅	650
	90	2900	1400	2200	1050	1900	850	1700 ₅	750	1600 ₁₀	650 ₁₀

Single span ridge/intermediate roof beam AS 4055 classification C1, C2 and C3 (Cont'd)

Roof load width (mm)		1500		3000		4500		6000		7500	
Member size DxB (mm)	Roof mass (kg/m ²)	span	O/H	span	O/H	span	O/H	span	O/H	span	O/H
		Maximum recommended ridge/intermediate roof beam - Single span (mm)									
190x42	40	4100	1550	2800	1100	2300	900	2000 ₅	800	1800 ₁₀	700
	90	3200	1550	2500	1150	2200	950	1900 ₁₀	800	1800 ₁₅	700 ₁₅
200x42	40	4300	1600	2900	1150	2400	950	2100 ₅	800	1800 ₁₀	750
	90	3400	1600	2600	1200	2300 ₅	950	2100 ₁₀	850	1900 ₂₀	750 ₂₀
240x42	40	5100	1950	3400	1350	2800 ₅	1100	2400 ₁₀	950	2200 ₁₅	850
	90	4000	1950	3200	1400	2800 ₁₀	1150	2500 ₂₀	1000	2300 ₃₀	900 ₃₀
300x42	40	6300	2400	4200 ₅	1650	3400 ₁₅	1350	3000 ₂₀	1200	2700 ₃₀	1050
	90	5000	2400	4000 ₁₀	1700	3400 ₂₅	1400	3100 ₃₅	1200 ₃₅	2800 ₄₀	1100 ₄₀
2/150x42	40	4000	1550	3200	1250	2700	1050	2400	900	2100	800
	90	3200	1550	2500	1200	2200	1050	1900	900	1800	850
2/170x42	40	4500	1700	3600	1400	3100	1150	2700	1000	2400	900
	90	3600	1700	2800	1400	2400	1200	2200	1050	2000	900
2/190x42	40	5000	1900	4000	1550	3400	1300	3000	1100	2700	1000
	90	4000	1900	3200	1600	2700	1300	2500	1150	2300	1000
2/200x42	40	5300	2000	4200	1650	3600	1350	3100	1150	2800	1050
	90	4200	2000	3300	1600	2900	1350	2600	1200	2400	1050
2/240x42	40	6300	2400	5000	1900	4300	1550	3700	1350	3300 ₅	1200
	90	5000	2400	4000	2000	3500	1600	3100	1400	2900 ₅	1250
2/300x42	40	7800	3000	6300	2350	5200	1900	4500 ₁₀	1650	4000 ₁₅	1500
	90	6200	2850	5000	2400	4300	2000	3900 ₁₀	1700	3600 ₁₅	1550
2/360x42	40	9200	3600	7500	2750	6000 ₁₀	2250	5200 ₁₅	1950	4700 ₂₀	1750
	90	7400	3300	6000	2750	5200 ₁₀	2300	4700 ₁₅	2000	4300 ₂₅	1800
2/400x42	40	10200	4000	8200 ₅	3000	6600 ₁₀	2450	5700 ₂₀	2100	5100 ₂₅	1900
	90	8200	3550	6600	3000	5800 ₁₅	2500	5200 ₂₅	2150	4800 ₃₀	1950 ₃₀
150x58	40	3600	1350	2600	1050	2100	850	1900	750	1700	650
	90	2800	1350	2200	1100	1900	900	1700	750	1600	700
170x58	40	4100	1550	3000	1150	2400	950	2100	850	1900	750
	90	3200	1550	2500	1200	2200	1000	1900	850	1800	750
200x58	40	4800	1800	3400	1350	2800	1100	2400	950	2200 ₅	850
	90	3700	1800	2900	1400	2500	1150	2300 ₅	1000	2100 ₁₀	900
240x58	40	5700	2150	4000	1600	3300	1300	2900 ₅	1150	2600 ₁₀	1000
	90	4500	2150	3500	1650	3100 ₅	1350	2800 ₁₀	1150	2500 ₂₀	1050
300x58	40	7000	2650	4900	1950	4000 ₅	1600	3500 ₁₅	1400	3100 ₂₀	1250
	90	5600	2600	4400	2000	3800 ₁₀	1650	3500 ₂₀	1450	3200 ₃₀	1300 ₃₀
360x58	40	8300	3200	5700 ₅	2250	4700 ₁₅	1850	4100 ₂₀	1600	3700 ₃₀	1450
	90	6700	3000	5300 ₁₀	2350	4600 ₂₀	1900	4100 ₃₀	1650 ₃₀	3800 ₄₀	1500 ₄₀
400x58	40	9200	3550	6300 ₁₀	2450	5100 ₁₅	2000	4400 ₂₅	1750	4000 ₃₅	1550
	90	7400	3250	5900 ₁₀	2550	5100 ₂₅	2100	4600 ₄₀	1800 ₄₀	4200 ₅₀	1600 ₅₀
450x58	40	10300	4000	7000 ₁₅	2700	5600 ₂₀	2200	4900 ₃₀	1950	4400 ₄₀	1750
	90	8300	3550	6600 ₂₀	2800	5800 ₃₅	2300 ₃₅	5100 ₄₅	2000 ₄₅	4600 ₅₅	1800 ₅₅
240x75	40	5950	1950	4000	1300	3300	1050	2850	900	2550	800
	90	4700	1550	3750	1225	3250	1050	2800	900	2500	825
300x75	40	7000	2300	4900	1600	4000	1300	3500	1150	3100	1000
	90	5850	1925	4700	1550	4000	1300	3450	1100	3050	1000
400x75	40	8550	2800	6250	2050	5100	1675	4400	1450	3950	1300
	90	7250	2350	6150	2025	5050	1650	4350	1425	3900 ₅	1275 ₅
525x75	40	10350	3400	8050	2650	6350	2050	5500	1800	4950	1625
	90	8850	2900	7500	2475	6300 ₅	2075 ₅	5450 ₁₀	1750 ₁₀	4850 ₁₅	1600 ₁₅
300x82	40	7200	300	6100	2100	5400	1700	4800	1500	4400 ₅	1350
	90	6100	2800	4900	2150	4300	1750	3800	1550	3500 ₅	1400
400x82	40	8800	3950	7600	2750	6800 ₅	2250	6300 ₁₀	1950	5800 ₂₀	1750
	90	7500	3500	6400	2800	5700 ₅	2300	5100 ₁₀	2000	4700 ₂₀	1800 ₂₀

NOTES:

- Sizes in italics are SmartLVL 14
- D = member depth, B = member breadth, NS = not suitable.
- End bearing lengths = 35 mm at end supports and 70 mm at internal supports for continuous members. Subscript values indicate the minimum additional bearing length where required to be greater than 35 mm at end supports and 70 mm at internal supports.
- rafter spacing up to 1200 mm
- Not all sizes of SmartLVL in this table are stocked in each state. Please check with your supplier before ordering. WA only

Continuous span ridge/intermediate roof beam AS 4055 classification C1, C2 and C3

Roof Load width (mm)		1500		3000		4500		6000		7500	
Member size DxB (mm)	Roof mass (kg/m ²)	span	O/H	span	O/H	span	O/H	span	O/H	span	O/H
Maximum recommended ridge/Intermediate roof beam - Continuous span (mm)											
150x35	40	2650	850	1850	600	1500	450	1300 ₁₀	425	1100 ₁₅	350 ₁₅
	90	2650	850	1850	600	1500 ₁₀	450	1250 ₂₀	400 ₂₀	1100	350
170x35	40	2950	950	2100	650	1700 ₅	550	1450 ₂₀	475	1250	400
	90	3000	950	2100	650	1700 ₂₀	550	1450 ₅	475 ₅	1200 ₅	350 ₅
200x35	40	3500	1150	2400	750	2000 ₂₅	650	1700 ₅	550	1450 ₅	475 ₅
	90	3500	1150	2450 ₁₅	800	1950 ₅	600	1650 ₁₀	500 ₁₀	1450 ₁₅	475 ₁₅
240x35	40	4150	1350	2850 ₁₅	900	2350 ₅	775	2000 ₁₀	650 ₁₀	1750 ₁₅	575 ₁₅
	90	4200	1375	2850 ₅	900	2350 ₁₀	775 ₁₀	2000 ₁₅	650 ₁₅	1700 ₂₀	550 ₂₀
300x35	40	5200 ₁₀	1700	3500 ₅	1150	2850 ₁₅	900 ₁₅	2500 ₂₀	825 ₂₀	2200 ₂₅	725 ₂₅
	90	5250 ₂₅	1725	3500 ₁₀	1150 ₁₀	2850 ₂₀	900 ₂₀	2450 ₃₀	800 ₃₀	2150 ₁₄₅	700 ₁₄₅
2/150x35	40	4050	1325	2800	900	2300	750	2000	650	1800	550
	90	3950	1300	2850	900	2300	750	2000	650	1750 ₁₀	575
2/170x35	40	4600	1500	3150	1000	2600	850	2250	700	2000 ₅	650
	90	4450	1450	3150	1000	2600	850	2200 ₁₀	725	2000 ₂₀	650
2/190x35	40	5100	1675	3500	1150	2850	900	2500 ₅	825	2200 ₁₅	725
	90	5000	1600	3500	1150	2850 ₅	900	2450 ₂₀	800	2200	725
2/200x35	40	5350	1750	3650	1200	3000	950	2600 ₁₀	850	2350 ₂₅	775
	90	5250	1650	3650	1200	3000 ₁₀	950	2550 ₂₀	800	2300 ₅	750
2/240x35	40	6350	2050	4300	1400	3550 ₁₀	1150	3050 ₂₅	1000	2750 ₅	900
	90	6200	1900	4300 ₅	1400	3500 ₂₅	1150	3050 ₅	1000	2700 ₁₀	850
2/300x35	40	7850	2550	5300 ₁₀	1700	4300	1400	3750 ₁₀	1225 ₁₀	3350 ₁₅	1100 ₁₅
	90	7300	2225	5250 ₂₅	1725	4300 ₁₀	1400	3700 ₁₅	1200 ₁₅	3300 ₂₀	1050 ₂₀
150x42	40	3200	1200	2200	900	1800	750	1400	650	1300	550
	90	3400	1200	2300	900	1900	750	1600	650	1300	600
170x42	40	3600	1400	2500	1000	2000	800	1600	700	1400	650
	90	3800	1400	2600	1050	2100	850	1800	750	1500	650
190x42	40	4100	1550	2800	1100	2300	900	1800	800	1600	700
	90	4300	1550	2900	1150	2400	950	2000	800	1700	700
200x42	40	4300	1600	2900	1150	2400	950	1900	800	1700	750
	90	4500	1600	3100	1200	2500	950	2100	850	1700 ₁₀	750 ₁₀
240x42	40	5100	1950	3400	1350	2800	1100	2300	950	2000	850
	90	5400	1950	3600	1400	2900	1150	2500 ₁₅	1000	2100 ₃₀	900 ₃₀
300x42	40	6300	2400	4200	1650	3400	1350	2900	1200	2500	1050
	90	6700	2400	4400	1700	3600 ₂₀	1400	3100 ₄₀	1200 ₄₀	2600 ₅₀	1100 ₅₀
2/150x42	40	5000	1550	3400	1250	2800	1050	2400	900	2100	800
	90	4300	1550	3400	1300	2900	1050	2500	900	2300	850
2/170x42	40	5600	1700	3800	1400	3100	1150	2700	1000	2400	900
	90	4900	1700	3900	1450	3300	1200	2800	1050	2500	900
2/190x42	40	6200	1900	4200	1550	3400	1300	3000	1100	2700	1000
	90	5400	1900	4300	1600	3600	1300	3100	1150	2800	1000
2/200x42	40	6500	2000	4400	1650	3600	1350	3100	1150	2800	1050
	90	5700	2000	4500	1700	3800	1350	3300	1200	2900	1050
2/240x42	40	7700	2400	5200	1900	4300	1550	3700	1350	3300	1200
	90	6800	2400	5400	2000	4500	1600	3900	1400	3500 ₅	1250
2/300x42	40	9500	3000	6400	2350	5200	1900	4500	1650	4000	1500
	90	8500	2850	6700	2400	5500	2000	4700 ₁₀	1700	4300 ₂₅	1550
2/360x42	40	11100	3600	7500	2750	6000	2250	5200	1950	4700	1750
	90	10100	3300	7900	2750	6300 ₁₀	2300	5500 ₃₀	2000	4900 ₄₅	1800
2/400x42	40	12000	4000	8200	3000	6600	2450	5700	2100	5100	1900
	90	11200	3550	8700	3000	6900 ₂₀	2500	6000 ₄₀	2150	5400 ₆₀	1950 ₆₀

Continuous span ridge/intermediate roof beam AS 4055 classification C1, C2 and C3 (cont'd)

Roof load width (mm)		1500		3000		4500		6000		7500	
Member size DxB (mm)	Roof mass (kg/m ²)	span	O/H	span	O/H	span	O/H	span	O/H	span	O/H
		Maximum recommended ridge/intermediate roof beam - Continuous span (mm)									
150x58	40	3600	1350	2600	1050	2100	850	1900	750	1700	650
	90	2800	1350	2200	1100	1900	900	1700	750	1600	700
170x58	40	4100	1550	3000	1150	2400	950	2100	850	1900	750
	90	3200	1550	2500	1200	2200	1000	1900	850	1800	750
200x58	40	4800	1800	3400	1350	2800	1100	2400	950	2200 ₅	850
	90	3700	1800	2900	1400	2500	1150	2300 ₅	1000	2100 ₁₀	900
240x58	40	5700	2150	4000	1600	3300	1300	2900 ₅	1150	2600 ₁₀	1000
	90	4500	2150	3500	1650	3100 ₅	1350	2800 ₁₀	1150	2500 ₂₀	1050
300x58	40	7000	2650	4900	1950	4000 ₅	1600	3500 ₁₅	1400	3100 ₂₀	1250
	90	5600	2600	4400	2000	3800 ₁₀	1650	3500 ₂₀	1450	3200 ₃₀	1300 ₃₀
360x58	40	8300	3200	5700 ₅	2250	4700 ₁₅	1850	4100 ₂₀	1600	3700 ₃₀	1450
	90	6700	3000	5300 ₁₀	2350	4600 ₂₀	1900	4100 ₃₀	1650 ₃₀	3800 ₄₀	1500 ₄₀
400x58	40	9200	3550	6300 ₁₀	2450	5100 ₁₅	2000	4400 ₂₅	1750	4000 ₃₅	1550
	90	7400	3250	5900 ₁₀	2550	5100 ₂₅	2100	4600 ₄₀	1800 ₄₀	4200 ₅₀	1600 ₅₀
450x58	40	10300	4000	7000 ₁₅	2700	5600 ₂₀	2200	4900 ₃₀	1950	4400 ₄₀	1750
	90	8300	3550	6600 ₂₀	2800	5800 ₃₅	2300 ₃₅	5100 ₄₅	2000 ₄₅	4600 ₅₅	1800 ₅₅
240x75	40	<i>6050</i>	<i>1950</i>	<i>4000</i>	<i>1300</i>	<i>3300</i>	<i>1050</i>	<i>2850₁₀</i>	<i>900</i>	<i>2550₂₅</i>	<i>800</i>
	90	<i>6000</i>	<i>1925</i>	<i>4000</i>	<i>1300</i>	<i>3250₁₀</i>	<i>1050</i>	<i>2800₂₅</i>	<i>900</i>	<i>2500₅</i>	<i>825</i>
300x75	40	<i>7450</i>	<i>2450</i>	<i>4900</i>	<i>1600</i>	<i>4000₁₅</i>	<i>1300</i>	<i>3500₅</i>	<i>1150</i>	<i>3100₅</i>	<i>1000₅</i>
	90	<i>7400</i>	<i>2250</i>	<i>4900₁₀</i>	<i>1600</i>	<i>4000</i>	<i>1300</i>	<i>3450₁₀</i>	<i>1100</i>	<i>3050₁₀</i>	<i>1000₁₀</i>
400x75	40	<i>9550</i>	<i>3150</i>	<i>6250₂₀</i>	<i>2050</i>	<i>5100₅</i>	<i>1675</i>	<i>4400₁₀</i>	<i>1450₁₀</i>	<i>3950₂₀</i>	<i>1300₂₀</i>
	90	<i>9150₅</i>	<i>2775</i>	<i>6200₅</i>	<i>2000</i>	<i>5050₁₀</i>	<i>1650₁₀</i>	<i>4350₂₀</i>	<i>1425₂₀</i>	<i>3900₂₅</i>	<i>1275₂₅</i>
525x75	40	<i>12000₂₀</i>	<i>3950</i>	<i>8050₁₀</i>	<i>2650</i>	<i>6350₁₅</i>	<i>2050₁₅</i>	<i>5500₂₅</i>	<i>1800₂₅</i>	<i>4950₃₀</i>	<i>1625₃₀</i>
	90	<i>11100₂₅</i>	<i>3375</i>	<i>7950₁₅</i>	<i>2600₁₅</i>	<i>6300₂₅</i>	<i>2075₂₅</i>	<i>5450₃₀</i>	<i>1750₃₀</i>	<i>4850₁₅₅</i>	<i>1600₁₅₅</i>
300x82	40	9100	3000	7100	2100	5700	1700	5000 ₁₀	1500	4500 ₂₀	1350
	90	7700	2800	6500	2150	5400 ₁₀	1750	4700 ₂₅	1550	4200 ₃₅	1400
400x82	40	11100	3950	9500 ₅	2750	7400 ₂₀	2250	6400 ₃₅	1950	5800 ₅₀	1750
	90	9500	3500	8000 ₁₀	2800	7000 ₃₅	2300	6100 ₅₅	2000	5400 ₈₀	1800 ₈₀

NOTES:

- Sizes in italics are SmartLVL 14
- D = member depth, B = member breadth, NS = not suitable.
- End bearing lengths = 35 mm at end supports and 70 mm at internal supports for continuous members. Subscript values indicate the minimum additional bearing length where required to be greater than 35 mm at end supports and 70 mm at internal supports.
- rafter spacing up to 1200 mm
- Not all sizes of SmartLVL in this table are stocked in each state. Please check with your supplier before ordering WA only

Single span Verandah beam AS 4055 classification N1, N2 and N3

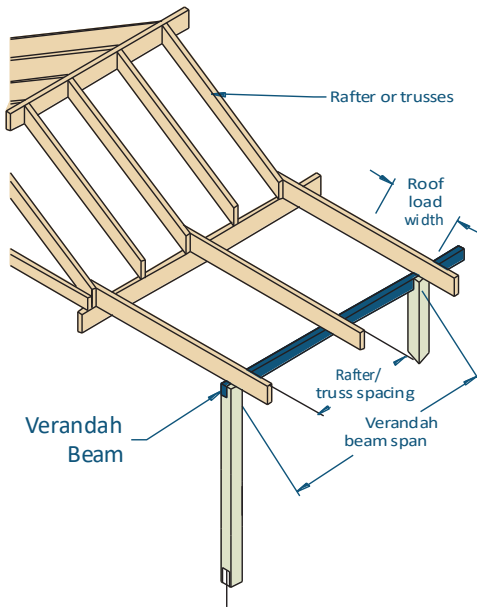

EXAMPLE:

wind speed = N3
 sheet roof - 40 kg/m²
 rafter/truss spacing = 600 mm
 verandah span = 3500 mm
 roof load width = 3900 mm
 Enter span table at 4500 roof load width column, rafter spacing of 600 mm, and read down to a span equal to or greater than 3500 mm

ADOPT:

SmartLVL 14 - 300x35

Roof load width (mm)		1500		3000		4500		6000		7500	
Rafter/truss spacing (mm)		600	1200	600	1200	600	1200	600	1200	600	1200
Member size DxB (mm)	Roof mass (kg/m ²)	Maximum recommended Verandah beam span - Single span (mm)									
150x35	10	3400	3400	2700	2700	2200	2100	1900	1600	1600	1200
	20	3400	3400	2700	2700	2300	2200	1900	1700	1700	1300
	40	2700	2800	2200	2200	1900	1900	1700	1700	1600	1500
	60	2400	2400	1900	1900	1600	1600	1500	1400	1400	1200
	90	2100	2100	1600	1600	1400	1300	1300	1100	1200 ₅	NS
170x35	10	3900	3900	3100	2900	2500	2400	2100	2000	1900	1500
	20	3900	3800	3100	3000	2600	2500	2200	2100	1900	1600
	40	3100	3100	2500	2500	2200	2100	2000	1900	1800	1800
	60	2700	2700	2200	2100	1900	1900	1700	1600	1600	1500 ₁₀
	90	2400	2400	1900	1900	1600	1500	1500	1300	1400 ₅	1200 ₅
200x35	10	4600	4600	3600	3400	2900	2800	2500	2400	2200	2100
	20	4400	4400	3600	3500	3000	2900	2600	2500	2300	2200
	40	3600	3600	2900	2900	2500	2600	2300	2300	2100	2100 ₅
	60	3200	3200	2500	2600	2200	2200	2000	2000	1900	1800 ₅
	90	2800	2800	2200	2200	1900	1900	1700	1700 ₅	1600 ₅	1500 ₂₀
240x35	10	5500	5500	4200	4200	3500	3300	2900	2900	2600	2600
	20	5000	5000	4300	4300	3500	3400	3000	2900	2700	2600 ₅
	40	4300	4300	3500	3500	3100	3000	2800	2800 ₁₀	2600 ₅	2600 ₁₅
	60	3800	3800	3100	3000	2700	2700	2400 ₅	2400 ₁₀	2300 ₅	2200 ₁₀
	90	3400	3300	2700	2700	2300	2300	2100	2100 ₁₀	2000 ₅	1900 ₁₅
300x35	10	6700	6700	5200	5200	4200	4100	3700	3500	3300	3100 ₅
	20	5900	5800	5000	5000	4300	4300	3800 ₅	3600	3300	3200 ₅
	40	5000	5000	4300	4300	3800	3800	3500 ₁₀	3400 ₅	3200 ₅	3200 ₁₅
	60	4600	4600	3800	3800	3400	3300	3000 ₅	3000 ₁₅	2800 ₁₅	2800 ₃₀
	90	4100	4100	3400	3300	2900 ₁₀	2900 ₁₅	2700 ₁₅	2700 ₂₅	2500 ₂₅	2400 ₄₀
150x42	10	4000	3900	3400	3300	2700	2700	2400	2300	2100	2000
	20	3700	3600	3000	3000	2600	2700	2400	2300	2200	2100
	40	3000	3000	2400	2400	2100	2000	1900	1900	1700	1700
	60	2600	2700	2100	2000	1800	1800	1600	1500	1500	1400
	90	2300	2300	1800	1800	1600	1500	1400	1300	1300	1100

Single span Verandah beam AS 4055 classification N1, N2 and N3 (Cont'd)

Roof load width (mm)		1500		3000		4500		6000		7500	
Rafter/truss spacing (mm)		600	1200	600	1200	600	1200	600	1200	600	1200
Member size DxB (mm)	Roof mass (kg/m ²)	Maximum recommended Verandah beam span - Single span (mm)									
170x42	10	4400	4300	3800	3700	3100	3000	2700	2600	2400	2300
	20	4100	4100	3400	3300	2900	2900	2700	2700 ₅	2500	2300
	40	3400	3300	2700	2700	2300	2400	2100	2100	2000	1900 ₅
	60	2900	2900	2300	2400	2100	2000	1800	1800	1700	1700 ₅
	90	2600	2600	2100	2000	1800	1800	1600	1500 ₅	1500	1400
200x42	10	5200	5300	4400	4400	3600	3400	3100	3000	2800	2700 ₅
	20	4600	4600	3900	3900	3500	3400	3200	3000	2800 ₅	2700 ₁₀
	40	3900	3900	3200	3100	2800	2800	2500	2600 ₅	2300 ₅	2300 ₅
	60	3500	3400	2800	2800	2400	2400	2200	2200	2000	2000 ₅
	90	3000	3000	2400	2400	2100	2100	1900	1900	1800	1700 ₁₀
240x42	10	6000	6000	5200	5200	4300	4200	3700 ₅	3500	3300	3100 ₅
	20	5300	5300	4500	4500	4100	4100	3800 ₅	3600 ₅	3400 ₁₀	3200 ₁₀
	40	4500	4500	3800	3800	3300	3300	3000	3000 ₅	2800 ₁₀	2800 ₂₀
	60	4100	4100	3300	3300	2900	2900	2700 ₅	2700 ₁₀	2400 ₁₀	2400 ₂₀
	90	3700	3600	2900	2900	2500	2600 ₅	2300 ₅	2300 ₅	2200 ₁₅	2100 ₁₅
300x42	10	7000	7000	6200	6100	5200 ₅	5200 ₅	4500 ₅	4500 ₁₀	4000 ₁₀	3900 ₁₀
	20	6200	6100	5300	5300	4900 ₅	4800 ₁₀	4500 ₅	4500 ₁₀	4100 ₂₀	4000 ₁₅
	40	5300	5300	4500	4500	4100 ₅	4100 ₁₀	3800 ₁₀	3800 ₁₀	3500 ₂₀	3500 ₁₅
	60	4900	4800	4100	4100	3600 ₅	3600	3300 ₅	3300 ₁₀	3100 ₁₅	3100 ₂₅
	90	4400	4400	3600	3600	3200	3200 ₅	2900 ₁₅	2900 ₂₅	2700 ₃₀	2700 ₃₀
360x42	10	7900	7900	7000	7000	6200 ₁₀	6100 ₅	5300 ₂₀	5300 ₂₀	4800 ₂₅	4800 ₃₀
	20	7000	7000	6100	6000	5500 ₅	5500 ₁₀	5200 ₁₅	5200 ₂₅	4900 ₃₀	4900 ₃₅
	40	6100	6000	5200	5200	4700	4700 ₅	4400 ₁₅	4400 ₂₀	4200 ₃₀	4200 ₄₀
	60	5500	5500	4700	4700	4300 ₁₀	4300 ₁₅	4000 ₁₅	4000 ₁₅	3700 ₃₀	3700 ₂₅
	90	5100	5000	4300	4300 ₅	3800 ₁₀	3800 ₁₀	3500 ₁₀	3400 ₁₅	3200 ₂₀	3200 ₃₅
400x42	10	8500	8400	7500	7500 ₅	6800 ₁₀	6800 ₁₅	5900 ₁₅	5800 ₂₀	5200 ₂₅	5200 ₃₀
	20	7500	7500	6600	6500	6000 ₅	6000 ₁₀	5600 ₂₀	5600 ₂₅	5300 ₃₀	5300 ₃₅
	40	6500	6600	5600	5600	5100 ₁₀	5100 ₁₅	4800 ₂₅	4700 ₃₀	4500 ₂₅	4500 ₃₅
	60	6000	6000	5100	5100 ₅	4600 ₅	4600 ₁₀	4300 ₂₀	4300 ₃₀	4100 ₃₀	4100 ₂₅
	90	5500	5400	4600	4600	4200 ₁₀	4200 ₁₀	3900 ₂₅	3800 ₂₀	3600 ₄₀	3600 ₃₀
150x58	10	4400	4300	3900	3700	3100	3000	2700	2600	2400	2300
	20	4000	4000	3300	3200	2900	2900	2600	2700	2400	2400
	40	3300	3200	2600	2700	2300	2300	2100	2100	1900	1900
	60	2900	2900	2300	2300	2000	2000	1800	1800	1700	1600
	90	2500	2600	2000	2000	1700	1700	1600	1500	1500	1300
170x58	10	4900	5000	4300	4200	3500	3400	3000	2900	2700	2600
	20	4400	4400	3700	3700	3300	3200	3000	3000	2700	2700
	40	3700	3700	3000	3000	2600	2700	2400	2400	2200	2200
	60	3300	3200	2600	2700	2300	2300	2100	2000	1900	1900
	90	2900	2900	2300	2300	2000	2000	1800	1800	1700	1600
200x58	10	5600	5600	4900	5000	4100	4000	3500	3400	3100	3000
	20	4900	5000	4300	4200	3900	3800	3500	3400	3200	3100
	40	4300	4200	3500	3500	3100	3100	2800	2800	2600	2700
	60	3900	3800	3100	3100	2700	2700	2400	2500	2300	2200
	90	3400	3300	2700	2700	2300	2300	2100	2100	2000	1900
240x58	10	6400	6300	5600	5600	4800	4800	4200	4000	3700	3600
	20	5600	5600	4900	4900	4400	4400	4100	4100	3800	3600
	40	4900	4900	4100	4100	3700	3700	3400	3300	3100	3100
	60	4400	4400	3700	3700	3200	3200	2900	2900	2700 ₅	2800 ₁₀
	90	4000	4000	3200	3200	2800	2800	2600	2600 ₅	2400 ₅	2400 ₁₀
300x58	10	7400	7300	6600	6600	5900	5800	5100	5100 ₅	4600	4500 ₅
	20	6600	6600	5700	5700	5200	5200	4900 ₅	4900 ₅	4600 ₁₀	4600 ₁₀
	40	5700	5700	4900	4900	4400	4400	4100	4100 ₅	3900 ₅	3900 ₅
	60	5200	5200	4400	4400	4000	4000	3700 ₅	3600	3400 ₁₀	3400 ₅
	90	4800	4700	4000	4000	3600	3500	3200	3200 ₅	3000 ₁₀	3000 ₁₅

Single span Verandah beam AS 4055 classification N1, N2 and N3 (Cont'd)

Roof load width (mm)		1500		3000		4500		6000		7500	
Rafter/truss spacing (mm)			1200	600	1200	600	1200	600	1200	600	1200
Member size (DxB (mm))	Roof mass (kg/m ²)	Maximum recommended Verandah beam span - Single span (mm)									
360x58	10	8300	8300	7500	7500	6900	7000	6500	6500	6100	6000
	20	7500	7500	6500	6500	6000	6000	5600	5600	5300	5300
	40	6500	6500	5600	5600	5100	5100	4800	4800	4500	4600
	60	6000	6000	5100	5100	4700	4700	4300	4300	4100	4100
	90	5500	5500	4700	4700	4200	4200	3900	3900	3600 ₁₀	3600 ₅
400x58	10	8900	8900	8000	8000	7500	7500	7000	7100	6600	6600
	20	8000	8000	7100	7100	6500	6500	6100	6000	5800	5700
	40	7000	7100	6100	6000	5500	5500	5200	5200	4900	4900
	60	6500	6500	5500	5500	5000	5000	4700	4700	4400	4500
	90	5900	5900	5000	5000	4600	4600	4200 ₅	4200 ₁₀	4000 ₁₀	4000 ₅
450x58	10	9600	9600	8700	8700	8100	8100	7600	7600	7300	7300
	20	8700	8700	7700	7600	7000	7100	6600	6600	6300	6300
	40	7700	7600	6600	6600	6000	6000	5600	5600	5300	5300
	60	7100	7100	6000	6000	5500	5500	5100	5100	4900	4900 ₅
	90	6400	6400	5500	5500	5000	5000	4600	4700 ₅	4400 ₁₅	4400 ₂₅
240x75	10	6600	6600	5800	5800	5400	5400	5100	5100	4700	4600
	20	5800	5800	5100	5100	4600	4600	4300	4300	4100	4100
	40	5100	5100	4300	4300	3900	3900	3600	3500	3300	3300
	60	4600	4600	3900	3900	3500	3400	3100	3100	2900	2900
	90	4200	4200	3500	3400	3000	3000	2700	2800	2500	2500
300x75	10	7600	7600	6800	6800	6300	6300	5900	5900	5700	5600
	20	6800	6800	6000	5900	5400	5400	5100	5100	4900	4800
	40	6000	5900	5100	5100	4700	4600	4300	4300	4100	4100
	60	5500	5400	4700	4600	4200	4200	3900	3900	3700	3600
	90	5000	5000	4200	4200	3800	3700	3500	3400	3200	3200
400x75	10	9100	9100	8300	8200	7700	7700	7300	7300	7000	6900
	20	8200	8200	7300	7300	6700	6700	6300	6300	6000	6000
	40	7300	7300	6300	6300	5800	5700	5400	5400	5100	5100
	60	6700	6700	5800	5700	5200	5200	4900	4900	4600	4600
	90	6100	6100	5200	5200	4800	4700	4400	4400 ₅	4200 ₅	4200 ₅
525x75	10	10700	10700	9900	9800	9200	9300	8800	8800	8400	8400
	20	9800	9800	8800	8800	8100	8100	7600	7700	7300	7300
	40	8800	8800	7700	7600	7000	7000	6600	6600	6200	6200
	60	8100	8100	7000	7000	6400	6400	6000	6000	5700 ₅	5600 ₁₀
	90	7500	7400	6400	6400	5800	5800 ₅	5400 ₁₀	5400 ₁₅	5100 ₂₀	5100 ₂₅
300x82	10	7700	7700	7000	7000	6500	6500	5800	5700	5100	5100
	20	7000	7000	6100	6100	5600	5600	5300	5300	5000	5000 ₅
	40	6100	6100	6300	5300	4800	4800	4500	4500	4300	4300
	60	5600	5600	4800	4800	4400	4400	4100	4100	3800	3800
	90	5200	5200	4400	4400	4000	4000	3600	3600	3400	3400
400x82	10	9200	9200	8400	8400	7900	7900	7500	7500 ₅	6700 ₅	6600 ₅
	20	8400	8400	7500	7500	6900	6900	6500	6500	6200 ₅	6200 ₅
	40	7500	7500	6500	6500	6000	5900	5600	5600	5300 ₅	5300 ₁₀
	60	6900	6900	6000	5900	5400	5400	5100	5100 ₅	4800 ₁₀	4800 ₁₅
	90	6400	6300	5400	5400	4900	4900	4600	4600 ₅	4400 ₁₀	4300 ₁₅

NOTES:

- Sizes in italics are SmartLVL 14
- D = member depth, B = member breadth, NS = not suitable.
- End bearing lengths = 45 mm at end supports and 70 mm at internal supports for continuous members. Subscript values indicate the minimum additional bearing length where required to be greater than 35 mm at end supports and 70 mm at internal supports
- Restraint value for slenderness calculations is 1200 mm
- Not all sizes of SmartLVL in this table are stocked in each state. Please check with your supplier before ordering WA only

Continuous span Verandah beam AS 4055 classification N1, N2 and N3

Roof load width (mm)		1500		3000		4500		6000		7500	
Rafter/truss spacing (mm)		600	1200	600	1200	600	1200	600	1200	600	1200
Member size DxB (mm)	Roof mass (kg/m ²)	Maximum recommended Verandah beam span - Continuous span (mm)									
150x35	10	4000	3900	2800	2800	2200	2200	1900	1600	1600	1300
	20	4000	4000	2800	2800	2300	2200	2000	1900	1600	1400
	40	3700	3700	3000	2900	2400	2600	2100	2000	1700	1600
	60	3200	3200	2600	2600	2200	2200	2000	2000	1900	1600 ₅
	90	2800	2800	2200	2200	1900	1900	1600	1500	1600	1200
170x35	10	4400	4400	3100	3100	2500	2600	2200	2100	1700	1500
	20	4600	4500	3200	3200	2600	2700	2200	2100	2000	1600
	40	4100	4100	3300	3300	2700	2800	2300	2200	2100	1700
	60	3700	3600	2900	2900	2600	2500	2300	2200	2100	2000
200x35	90	3200	3100	2600	2500	2200	2100	2000	1600 ₅	1700 ₅	1400 ₅
	10	5200	5200	3600	3500	2900	2900	2500	2600	2200	1700
	20	5300	5300	3700	3600	3000	3000	2600	2700	2300	1700
	40	4700	4600	3900	3900	3200	3100	2700	2800	2400	2600 ₅
	60	4200	4200	3400	3400	3000	3000	2700 ₅	2700 ₅	2500 ₁₅	2500 ₁₅
240x35	90	3800	3800	3000	3000	2600	2600 ₅	2400 ₂₀	2400 ₂₀	2100 ₃₀	1600 ₁₅
	10	6100	6000	4300	4300	3500	3400	3000	3000	2700	2700
	20	6200	6200	4400	4400	3500	3500	3100	3000	2700	2800
	40	5300	5300	4500	4500	3800	3700	3200 ₅	3200 ₅	2900 ₁₅	2900 ₁₅
	60	4800	4900	4100	4100	3600	3600 ₅	3300 ₂₀	3200 ₂₀	2900 ₃₅	2900 ₃₅
300x35	90	4400	4400	3600	3600	3200 ₂₀	3100 ₁₅	2800 ₃₅	2800 ₄₀	2500 ₅₀	2600 ₅₅
	10	7500	7500	5200	5200	4300	4300	3700	3600	3300	2900
	20	7100	7300	5400	5400	4400	4400	3800	3700	3400 ₁₅	3200 ₁₀
	40	6300	6300	5300	5300	4600 ₁₀	4600 ₁₀	4000 ₂₅	4000 ₂₅	3600 ₄₀	3500 ₄₀
	60	5700	5700	4800	4800	4400 ₂₀	4300 ₂₅	4000 ₄₅	4000 ₄₅	3600 ₆₅	3500 ₆₀
90	5200	5200	4400 ₁₀	4300 ₁₀	3900 ₄₅	3900 ₄₀	3500 ₇₀	3300 ₆₀	3100 ₉₀	3100 ₉₀	
150x42	10	4900	5000	3400	3400	2800	2800	2400	2500	2200	1600
	20	4700	4700	3500	3400	2800	2800	2500	2600	2200	1600
	40	4000	4000	3200	3100	2800	2800	2500	2500	2200	1600
	60	3500	3500	2800	2800	2500	2400	2200	2100	2000	1600 ₅
	90	3100	3100	2500	2400	2100	2100	1900	1600	1600	1400
170x42	10	5500	5500	3900	3800	3100	3100	2700	2700	2300	2100
	20	5100	5200	3900	3900	3200	3200	2800	2800	2500	2600
	40	4400	4400	3600	3600	3200	3100	2800	2800	2500 ₅	2600 ₅
	60	4000	3900	3200	3100	2800	2800	2500	2500 ₅	2300 ₅	1700
	90	3500	3500	2800	2800	2400	2400	2200	2100	2000 ₁₀	1600 ₁₀
200x42	10	6300	6300	4500	4400	3600	3500	3100	2900	2800	2800
	20	5800	5800	4600	4500	3700	3600	3200	3000	2900 ₅	2900 ₅
	40	4900	5000	4200	4200	3700	3700	3300 ₁₀	3200 ₅	2900 ₁₅	2900 ₁₅
	60	4500	4500	3700	3700	3300	3200	3000 ₁₀	2900 ₁₀	2700 ₂₀	2700 ₂₅
	90	4100	4100	3300	3200	2900	2900	2600 ₁₀	2600 ₁₀	2300 ₂₀	1700
240x42	10	7300	7500	5300	5300	4300	4300	3700	3600	3300 ₁₀	3100 ₅
	20	6500	6600	5400	5400	4400	4400	3800 ₁₀	3700 ₅	3400 ₂₀	3100 ₁₀
	40	5600	5700	4800	4800	4400 ₁₀	4300 ₁₀	3900 ₂₅	3800 ₂₀	3400 ₃₅	3100 ₂₀
	60	5100	5200	4400	4300	3900 ₁₀	3900 ₁₀	3600 ₂₅	3500 ₂₅	3200 ₄₀	3100 ₃₅
	90	4700	4600	3900	3900	3400 ₁₀	3400 ₁₀	3100 ₃₀	3100 ₂₅	2900 ₄₅	2900 ₄₅
300x42	10	10100	10100	7100	7100	5800	5700	5000	5000	4500	4500
	20	10400	10400	7300	7300	6000	5900	5100	5200	4600	4500
	40	11100	11000	7700	7800	6300	6300	5400 ₅	5400	4900 ₁₅	4800 ₁₅
	60	9900	9900	7100	7100	5900 ₂₀	5800 ₂₀	5100 ₄₀	5100 ₄₀	4600 ₅₅	4500 ₅₀
	90	8200	8100	5900 ₂₀	5800 ₂₀	4800 ₄₅	4700 ₄₅	4100 ₇₀	4100 ₇₀	3700 ₉₀	3600 ₉₀
360x42	10	11800	11800	8300	8200	6700	6700	5800	5800	5200	5200
	20	12000	12000	8500	8500	6900	6900	6000	5900	5300	5300
	40	12000	12000	9000	9000	7300 ₅	7300 ₅	6300 ₂₀	6300 ₂₀	5700 ₃₀	5600 ₃₀
	60	11300	11300	8200 ₁₅	8200 ₁₅	6800 ₄₀	6800 ₄₀	5900 ₆₀	5800 ₆₀	5300 ₈₀	5300 ₈₀
	90	9400 ₅	9400 ₅	6800 ₄₀	6800 ₄₀	5600 ₇₀	5500 ₇₀	4800 ₉₅	4800 ₉₅	4300 ₁₁₅	4300 ₁₁₅

Continuous span Verandah beam AS 4055 classification N1, N2 and N3 (Cont'd)

Roof load width (mm)		1500		3000		4500		6000		7500	
Rafter/truss spacing (mm)		600	1200	600	1200	600	1200	600	1200	600	1200
Member size DxB (mm)	Roof mass (kg/m ²)	Maximum recommended Verandah beam span - Continuous span (mm)									
400x42	10	12000	12000	9000	9000	7300	7300	6300	6300	5700	5600
	20	12000	12000	9300	9300	7500	7500	6500	6500	5800 ₅	5800 ₅
	40	12000	12000	9800	9800	8000 ₁₅	8000 ₁₅	6900 ₃₀	6900 ₃₀	6200 ₄₀	6100 ₄₀
	60	12000	12000	8900 ₂₅	8900 ₂₅	7400 ₅₀	7300 ₅₀	6400 ₇₅	6400 ₇₅	5700 ₉₅	5700 ₉₅
	90	10200 ₁₀	10200 ₁₀	7400 ₅₀	7300 ₅₀	6100 ₉₀	6000 ₈₅	5200 ₁₁₀	5300 ₁₁₀	4700 ₁₃₀	4600 ₁₃₀
150x58	10	6300	6300	4500	4400	3600	3500	3100	3100	2800	2800
	20	6500	6500	4600	4500	3700	3600	3200	3200	2900	2900
	40	6900	6900	4900	4900	4000	3900	3400	3300	3000	3000
	60	6300	6200	4500	4500	3700	3600	3200	3100	2800	2800
	90	5200	5200	3700	3600	3000	3000	2600	2700	2200	2100
170x58	10	7100	7100	5000	5000	4100	4100	3500	3400	3100	3100
	20	7300	7300	5100	5200	4200	4200	3600	3500	3200	3200
	40	7700	7800	5400	5400	4400	4400	3800	3800	3400	3400
	60	7000	7000	5000	5100	4100	4100	3600	3500	3200	3200
	90	5800	5700	4100	4100	3400	3300	2900	2900	2600	2700
200x58	10	8300	8200	5800	5700	4700	4700	4100	4100	3600	3600
	20	8500	8400	5900	5900	4800	4800	4200	4200	3700	3700
	40	9000	9000	6300	6300	5100	5200	4400	4400	4000	3900
	60	8100	8000	5800	5800	4800	4800	4100	4100	3700	3600
	90	6700	6600	4800	4800	3900	3900	3400	3300	3000 ₁₅	2900 ₁₀
240x58	10	9800	9800	6800	6800	5600	5500	4800	4800	4300	4300
	20	10000	10000	7000	7000	5700	5700	4900	5000	4400	4400
	40	10600	10600	7500	7500	6100	6000	5200	5200	4700	4600
	60	9400	9400	6800	6800	5600	5600	4900	4900	4400 ₁₀	4400 ₁₀
	90	7800	7800	5600	5600	4600 ₅	4500 ₅	4000 ₂₀	4000 ₂₀	3600 ₃₀	3500 ₃₀
300x58	10	12000	11900	8400	8300	6800	6800	5900	5800	5300	5300
	20	12000	12000	8600	8600	7000	7000	6100	6000	5400	5400
	40	12000	12000	9100	9100	7400	7400	6400	6400	5700	5700
	60	11400	11400	8300	8300	6800 ₅	6800 ₅	6000 ₂₀	5900 ₂₀	5300 ₃₀	5300 ₃₀
	90	9500	9500	6800 ₅	6800 ₅	5600 ₂₅	5600 ₂₅	4900 ₄₅	4800 ₄₅	4400 ₆₀	4400 ₆₀
360x58	10	9700	10300	8600	8600	7000 ₅	7000 ₅	6100 ₁₅	6000 ₁₅	5400 ₂₅	5400 ₂₅
	20	8700	9200	7800	8100	7200 ₁₀	7100 ₁₀	6200 ₂₅	6100 ₂₅	5500 ₃₅	5500 ₃₅
	40	7800	8100	6900	7000	6300 ₁₀	6300 ₁₅	5900 ₃₅	6000 ₃₅	5600 ₅₅	5600 ₅₅
	60	7200	7400	6300	6300	5800 ₁₅	5800 ₁₅	5400 ₃₅	5400 ₃₅	5100 ₆₀	5100 ₅₅
	90	6700	6800	5800	5800	5200 ₂₀	5200 ₂₀	4900 ₄₅	4900 ₄₅	4600 ₇₀	4600 ₇₀
400x58	10	10300	11000	9300	9400	7700 ₁₀	7700 ₁₀	6600 ₂₅	6600 ₂₅	6000 ₃₅	5900 ₃₅
	20	9200	9900	8200	8700	7700 ₂₀	7900 ₂₀	6800 ₃₅	6800 ₃₅	6100 ₄₅	6000 ₄₅
	40	8200	8700	7300	7500	6800 ₂₀	6800 ₂₀	6400 ₄₀	6400 ₄₀	6100 ₇₀	6100 ₇₅
	60	7700	8000	6800	6800	6200 ₂₀	6200 ₂₀	5800 ₄₅	5800 ₄₅	5500 ₇₅	5500 ₈₀
	90	7200	7300	6200	6200	5700 ₃₀	5700 ₃₀	5300 ₅₅	5300 ₅₅	5000 ₉₀	5000 ₉₀
450x58	10	11100	11900	10000	10500 ₅	8600 ₂₀	8500 ₂₀	7400 ₃₅	7400 ₃₅	6600 ₅₀	6600 ₅₀
	20	10000	10800	8900	9500	8200 ₂₅	8800 ₃₀	7600 ₄₅	7600 ₄₅	6800 ₆₅	6800 ₆₅
	40	8800	9500	7800	8200	7300 ₂₅	7500 ₃₀	6900 ₅₅	7000 ₅₅	6600 ₉₀	6600 ₉₀
	60	8300	8700	7300	7500 ₅	6800 ₃₀	6800 ₃₀	6400 ₅₅	6400 ₆₀	6000 ₉₅	6100 ₉₅
	90	7700	8000	6800 ₁₀	6800 ₁₀	6200 ₄₀	6200 ₄₀	5800 ₇₅	5800 ₇₅	5400 ₁₀₅	5400 ₁₀₅
240x75	10	7900	8300	6500	6500	5300	5300	4600	4500	4100	4100
	20	7200	7400	6400	6400	5400	5400	4700	4600	4200	4200
	40	6400	6400	5500	5500	5000	5000	4700	4600	4200	4200
	60	5900	5900	5000	5000	4500	4500	4200	4200	4000 ₅	4000 ₅
	90	5400	5300	4500	4500	4100	4100	3800	3700	3500 ₅	3500 ₅

Continuous span Verandah beam AS 4055 classification N1, N2 and N3 (cont'd)

Roof load width (mm)		1500		3000		4500		6000		7500	
Rafter/truss spacing (mm)		600	1200	600	1200	600	1200	600	1200	600	1200
Member size DxB (mm)	Roof mass (kg/m ²)	Maximum recommended Verandah beam span - Continuous span (mm)									
300x75	10	9000	9500	8000	8000	6500	6500	5600	5600	5000	5000
	20	8200	8600	7300	7500	6600	6600	5700	5700	5100 ₅	5200 ₅
	40	7300	7500	6400	6500	5900	5900	5500 ₅	5500 ₅	5200 ₁₅	5200 ₁₅
	60	6800	6900	5900	5900	5400	5400	5000 ₅	5000 ₅	4700 ₂₀	4700 ₂₀
	90	6300	6300	5400	5400	4900	4900	4500 ₁₀	4500 ₁₀	4300 ₂₅	4300 ₂₅
400x75	10	10700	11400	9700	10300	8400	8400	7300 ₁₀	7200 ₁₀	6500 ₂₀	6500 ₂₀
	20	9700	10400	8600	9200	8000	8500 ₅	7400 ₁₅	7400 ₁₅	6600 ₃₀	6600 ₂₅
	40	8600	9200	7700	8000	7100	7300 ₅	6800 ₂₀	6800 ₂₀	6500 ₄₀	6500 ₄₀
	60	8100	8500	7100	7300	6600 ₅	6600 ₅	6200 ₂₅	6200 ₂₅	5900 ₄₅	5900 ₄₅
	90	7500	7800	6600	6600	6000 ₁₀	6000 ₁₀	5600 ₃₀	5600 ₃₀	5300 ₅₀	5300 ₅₀
525x75	10	12000	12000	11400	12000	10700 ₂₀	10800 ₂₀	9300 ₃₅	9300 ₃₅	8300 ₄₅	8300 ₄₅
	20	11400	12000	10200	11100	9400 ₁₅	10200 ₂₀	9000 ₃₅	9500 ₄₅	8500 ₆₀	8500 ₆₀
	40	10200	11100	9000	9700	8400 ₁₅	8900 ₂₀	8000 ₄₀	8300 ₄₅	7600 ₆₅	7900 ₇₅
	60	9500	10200	8400	8900	7800 ₂₀	8100 ₂₅	7400 ₄₅	7600 ₄₅	7100 ₇₅	7200 ₈₅
	90	8800	9400	7800	8100 ₅	7200 ₃₀	7400 ₃₀	6800 ₅₅	6900 ₅₅	6500 ₉₀	6500 ₉₀
300x82	10	9100	9600	8200	8200	6700	6700	5800	5700	5200	5200
	20	8300	8700	7400	7600	6800	6800	5900	5800	5300	5300
	40	7400	7600	6600	6600	6000	6000	5600	5700	5300 ₁₀	5300 ₁₀
	60	6900	7000	6000	6000	5500	5500	5100	5100	4800 ₁₅	4800 ₁₀
	90	6400	6400	5500	5500	5000	5000	4600 ₅	4600 ₅	4400 ₂₀	4400 ₂₀
400x82	10	10800	11500	9800	10500	8700	8700	7500 ₅	7500 ₅	6700 ₁₅	6700 ₁₅
	20	9800	10500	8800	9400	8200	8700	7700 ₁₅	7700 ₁₅	6800 ₂₀	6900 ₂₅
	40	8800	9400	7800	8100	7200	7400	6900 ₁₅	6900 ₁₅	6600 ₃₀	6600 ₃₀
	60	8200	8700	7200	7400	6700	6800	6300 ₁₅	6300 ₁₅	6000 ₃₅	6000 ₃₅
	90	7600	7900	6700	6800	6100 ₅	6200 ₅	5700 ₂₅	5800 ₂₅	5400 ₄₀	5400 ₄₀

NOTES:

- Sizes in *Italics* are SmartLVL 14
- D = member depth, B = member breadth, NS = not suitable.
- End bearing lengths = 45 mm at end supports and 70 mm at internal supports for continuous members. Subscript values indicate the minimum additional bearing length where required to be greater than 35 mm at end supports and 70 mm at internal supports
- Restraint value for slenderness calculations is 1200 mm
- Not all sizes of SmartLVL in this table are stocked in each state. (Please check with your supplier before ordering. WA only)

Single span Verandah beam AS 4055 classification C1, C2 and C3

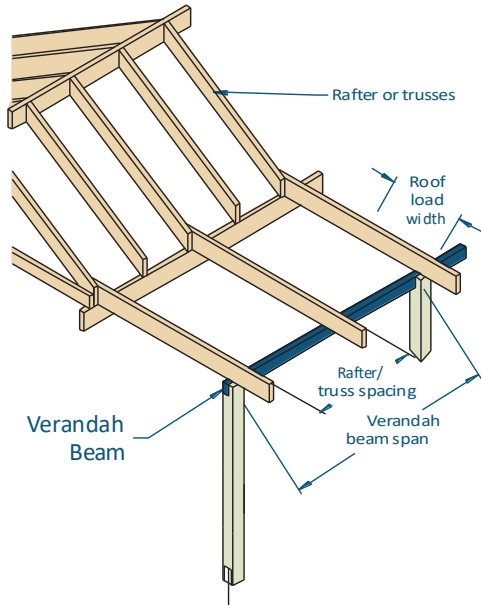

EXAMPLE:

wind speed = C3
 sheet roof - 40 kg/m²
 rafter/truss spacing = 600 mm
 verandah span = 3500 mm
 roof load width = 3900 mm
 Enter span table at 4500 roof load width column, rafter spacing of 600 mm, and read down to a span equal to or greater than 3500 mm

ADOPT:

SmartLVL 14 -300x35
 (with additional 10 mm bearing required)

Roof load width (mm)		1500		3000		4500		6000		7500	
Rafter/truss spacing (mm)		600	1200	600	1200	600	1200	600	1200	600	1200
Member size DxB (mm)	Roof mass (kg/m ²)	Maximum recommended Verandah beam span - Single span									
150x35	10	3000	3000	2200	2100	1700	1400	1500	NS	1300	NS
	20	3000	3000	2300	2100	1800	1500	1500	NS	1400	NS
	40	2700	2800	2200	2200	1800	1600	1600	NS	1400	NS
	60	2400	2400	1900	1900	1600	1600	1500	1100	1400 ₅	NS
	90	2100	2100	1600	1600	1400	1300	1300	1100	1200 ₁₀	NS
170x35	10	3400	3400	2500	2400	2000	1800	1700	1100	1500	NS
	20	3400	3400	2500	2500	2000	1900	1700	1200	1500	NS
	40	3100	3100	2500	2500	2100	2000	1800	1400 ₅	1600	NS
	60	2700	2700	2200	2100	1900	1900	1700	1500 ₅	1600 ₅	NS
	90	2400	2400	1900	1900	1600	1500	1500 ₅	1300 ₅	1400 ₁₀	NS
190x35	10	3800	3800	2800	2700	2300	2100	1900	1500	1700	NS
	20	3800	3800	2800	2700	2300	2200	1900	1600	1700	NS
	40	3500	3400	2800	2800	2400	2300	2000	1600	1800	1200
	60	3000	3000	2400	2400	2100	2100	1900	1900 ₅	1800	1400 ₅
	90	2700	2700	2100	2100	1800	1800	1600	1600 ₁₅	1500 ₁₅	1400 ₁₀
200x35	10	4000	4000	2900	2800	2400	2200	2000	1600	1700	1100
	20	4000	4000	2900	2800	2400	2300	2000	1700	1800	1200
	40	3600	3600	2900	2900	2500	2400 ₅	2100 ₅	2000 ₅	1900	1400
	60	3200	3200	2500	2600	2200	2200	2000	2000 ₁₀	1900 ₅	1500 ₂₀
	90	2800	2800	2200	2200	1900	1900	1700	1700 ₁₀	1600 ₁₀	1500 ₃₀
240x35	10	4900	4900	3500	3300	2800	2700	2400	2300	2100 ₅	1700 ₅
	20	4900	4900	3500	3300	2800	2800 ₅	2500 ₅	2300	2200 ₅	1700 ₅
	40	4300	4300	3500	3500	2900	2800 ₁₀	2500 ₁₀	2400 ₁₅	2300 ₁₀	1800 ₁₀
	60	3900	3800	3100	3000	2700	2700 ₁₀	2400 ₁₅	2400 ₂₅	2300 ₂₀	2200 ₂₀
	90	3400	3300	2700	2700	2300	2300 ₅	2100 ₅	2100 ₁₅	2000 ₁₀	1900 ₂₀
300x35	10	6100	6000	4200	4200	3500	3300	2900 ₅	2900 ₁₀	2600 ₁₀	2600 ₁₅
	20	5900	5800	4300	4200	3500 ₅	3300	3000 ₅	2900 ₁₅	2700 ₁₀	2600 ₂₀
	40	5000	5000	4300	4300	3600 ₁₀	3500 ₅	3100 ₁₀	3000 ₂₀	2800 ₂₀	2700 ₃₀
	60	4600	4600	3800	3800	3400 ₅	3300 ₁₀	3000 ₁₅	3000 ₂₅	2800 ₂₅	2800 ₃₅
	90	4100	4100	3400	3300	2900 ₁₅	2900 ₂₀	2700 ₂₀	2700 ₃₀	2500 ₃₅	2400 ₅₀

Single span Verandah beam AS 4055 classification C1, C2 and C3 (cont'd)

Roof Load Width (mm)		1500		3000		4500		6000		7500	
Rafter/Truss Spacing (mm)		600	1200	600	1200	600	1200	600	1200	600	1200
Member size DxB (mm)	Roof mass (kg/m ²)	Maximum recommended Verandah beam span - Single span									
150x42	10	3200	3100	2300	2100	1800	1000	1500	NS	NS	NS
	20	3200	3100	2300	2100	1800	1000	1500 ₅	NS	NS	NS
	40	3000	3000	2300	2200	1800	1300	1600 ₅	NS	1000	NS
	60	2600	2700	2100	2000	1800	1400 ₁₀	1600 ₅	NS	1400 ₂₀	NS
	90	2300	2300	1800	1800	1600	1400	1400 ₁₅	NS	1300 ₂₀	NS
170x42	10	3600	3400	2500	2400	2000	1500 ₅	1700	NS	1500 ₁₀	NS
	20	3700	3500	2600	2500	2000 ₅	1500 ₅	1700	NS	1500 ₁₅	NS
	40	3400	3300	2600	2600 ₅	2100 ₅	1600 ₅	1700 ₅	NS	1600 ₁₅	NS
	60	2900	2900	2300	2400 ₅	2100 ₁₀	1600 ₅	1700 ₅	NS	1600 ₁₅	NS
	90	2600	2600	2100	2000	1800	1600 ₁₀	1600 ₁₀	NS	1500 ₂₅	NS
200x42	10	4200	4100	2900	2800	2400 ₅	2300 ₅	2000 ₅	1300	1700 ₅	NS
	20	4200	4100	2900	2800	2400 ₁₀	2300 ₁₀	2000 ₅	1400	1700 ₁₀	NS
	40	3900	3900	3000	2900 ₅	2500 ₁₀	2300 ₂₀	2100 ₂₀	1500 ₂₅	1700 ₁₀	NS
	60	3500	3400	2800	2800 ₁₀	2400 ₁₅	2400 ₂₅	2200 ₂₅	1600 ₂₅	1700 ₁₅	NS
	90	3000	3000	2400	2400 ₁₀	2100 ₁₅	2100 ₁₅	1900 ₁₀	1500 ₃₀	1700 ₂₀	NS
240x42	10	5000	4900	3500	3300	2800 ₁₀	2700 ₁₅	2400 ₂₀	1800 ₁₅	1900 ₅	1400 ₅
	20	5000	5000	3500	3400 ₅	2800 ₁₅	2800 ₂₅	2500 ₂₅	1800 ₁₅	2100 ₁₅	1500 ₁₀
	40	4500	4500	3600 ₁₀	3400 ₅	2900 ₁₅	2800 ₂₅	2500 ₂₅	1900 ₁₅	2200 ₃₅	1600 ₄₀
	60	4100	4100	3300 ₁₀	3300 ₁₀	2900 ₂₀	2900 ₃₀	2600 ₃₀	2500 ₄₅	2300 ₃₅	1600 ₄₀
	90	3700	3600	2900 ₅	2900 ₁₀	2500 ₂₀	2600 ₃₀	2300 ₂₅	2300 ₃₀	2200 ₄₅	1600 ₅₀
300x42	10	6100	6000	4300 ₅	4200 ₁₅	3500 ₂₀	3300 ₁₅	3000 ₂₅	2900 ₄₀	2600 ₃₅	1900 ₂₅
	20	6100	6000	4300 ₁₀	4200 ₁₅	3500 ₂₅	3300 ₂₀	3000 ₃₀	2900 ₄₅	2600 ₃₅	2000 ₂₅
	40	5300	5300	4400 ₁₀	4300 ₁₅	3600 ₃₀	3400 ₂₅	3100 ₃₀	3000 ₄₅	2700 ₄₀	2100 ₂₅
	60	4900	4800	4100 ₁₅	4100 ₂₅	3600 ₃₅	3500 ₃₀	3100 ₃₅	3000 ₅₀	2800 ₄₅	2700 ₆₀
	90	4400	4400	3600 ₁₅	3600 ₁₅	3200 ₂₀	3200 ₃₀	2900 ₄₅	2900 ₆₀	2700 ₅₅	2700 ₇₀
360x42	10	7200 ₅	7200 ₅	5000 ₁₅	5000 ₂₀	4100 ₂₅	4000 ₂₀	3600 ₄₀	3400 ₃₅	3200 ₄₀	3000 ₆₀
	20	7000	7000	5100 ₂₀	5100 ₂₅	4100 ₃₅	4000 ₂₅	3600 ₄₅	3400 ₃₅	3200 ₄₅	3000 ₆₀
	40	6100	6000	5200 ₂₀	5200 ₂₅	4200 ₃₅	4100 ₃₀	3700 ₅₀	3500 ₄₀	3300 ₄₅	3100 ₆₅
	60	5500	5500	4700 ₁₀	4700 ₂₀	4300 ₄₀	4200 ₅₀	3800 ₅₅	3600 ₄₅	3300 ₅₀	3200 ₇₀
	90	5100	5000	4300 ₂₀	4300 ₃₀	3800 ₄₀	3800 ₃₅	3500 ₃₅	3400 ₅₀	3200 ₆₀	3200 ₈₀
400x42	10	7900 ₅	7800 ₁₀	5500 ₂₀	5500 ₂₅	4500 ₂₅	4500 ₃₅	3900 ₄₀	3800 ₃₅	3500 ₃₅	3300 ₅₅
	20	7500 ₅	7500 ₅	5600 ₂₀	5500 ₃₀	4600 ₃₀	4500 ₄₀	3900 ₄₅	3800 ₃₅	3500 ₄₀	3400 ₅₅
	40	6600	6500	5600 ₂₅	5600 ₃₀	4700 ₃₀	4700 ₄₀	4000 ₅₀	3900 ₄₅	3600 ₄₀	3400 ₆₀
	60	6000	6000	5100 ₂₅	5100 ₃₀	4600 ₃₅	4600 ₄₅	4100 ₅₅	4000 ₅₀	3700 ₈₀	3500 ₆₅
	90	5500	5400 ₅	4600 ₁₅	4600 ₂₅	4200 ₄₀	4200 ₄₀	3900 ₆₅	3800 ₅₅	3600 ₉₀	3500 ₇₅
150x58	10	3600	3500	2500	2500	2000	1900	1700	1100	1500	NS
	20	3700	3500	2600	2500	2100	1900	1700	1200	1500	NS
	40	3300	3200	2600	2600	2100	2000	1800	1400	1600	NS
	60	2900	2900	2300	2300	2000	2000	1800	1500 ₁₀	1600	NS
	90	2500	2600	2000	2000	1700	1700	1600	1400 ₁₀	1500 ₁₀	NS
170x58	10	4100	3900	2800	2800	2300	2200	2000	1500	1700	NS
	20	4100	4000	2900	2800	2400	2200	2000	1600	1700	NS
	40	3700	3700	2900	2800	2400	2300	2000	1600 ₅	1800	1100
	60	3300	3200	2600	2700	2300	2300	2100 ₁₀	1900 ₁₀	1800 ₅	1300 ₅
	90	2900	2900	2300	2300	2000	2000	1800	1800 ₁₀	1700 ₅	1300 ₁₀
200x58	10	4800	4700	3300	3200	2700	2600	2400 ₅	2200 ₅	2000	1500 ₁₀
	20	4800	4700	3400	3200	2700	2600 ₅	2400 ₅	2200 ₅	2100	1600 ₁₀
	40	4300	4200	3400	3300	2800	2700 ₅	2400 ₁₀	2300 ₁₀	2100 ₁₅	1600 ₁₅
	60	3900	3800	3100	3100	2700 ₅	2700 ₁₀	2400 ₁₅	2300 ₁₅	2200 ₁₅	1700 ₁₅
	90	3400	3300	2700	2700	2300 ₅	2300 ₁₅	2100 ₁₀	2100 ₁₅	2000 ₁₀	1700 ₂₀
240x58	10	5600	5500	3900	3800	3200	3000 ₅	2700 ₅	2700 ₁₅	2500 ₁₅	2300 ₂₅
	20	5600	5600	4000	3800	3200	3100 ₅	2800 ₁₀	2700 ₁₅	2500 ₁₅	2400 ₂₅
	40	4900	4900	4000	3900	3300	3100 ₅	2800 ₁₅	2700 ₂₅	2500 ₂₀	2400 ₃₀
	60	4400	4400	3700	3700	3200 ₅	3200 ₁₀	2900 ₁₅	2800 ₃₀	2600 ₂₅	2500 ₃₅
	90	4000	4000	3200	3200	2800 ₁₀	2800 ₁₅	2600 ₂₀	2600 ₃₀	2400 ₃₀	2400 ₄₀

Single span Verandah beam AS 4055 classification C1, C2 and C3 (cont'd)

Roof load width (mm)		1500		3000		4500		6000		7500		
		600	1200	600	1200	600	1200	600	1200	600	1200	
Member size DxB (mm)	Roof mass (kg/m ²)	Maximum recommended Verandah beam span - Single span										
300x58	10	6900	6800	4800	4800 ₅	3900 ₁₀	3800 ₅	3400 ₅	3200 ₁₅	3000 ₂₀	2900 ₃₅	
	20	6600	6600	4900 ₅	4800 ₁₀	4000 ₁₀	3800 ₁₀	3400 ₁₀	3300 ₁₅	3000 ₂₀	2900 ₃₅	
	40	5700	5700	4900 ₅	4900 ₁₀	4000 ₁₅	3900 ₁₀	3500 ₂₅	3300 ₂₀	3100 ₂₅	3000 ₄₀	
	60	5200	5200	4400	4400 ₅	4000 ₂₀	4000 ₁₅	3600 ₃₀	3400 ₂₅	3200 ₂₅	3000 ₄₀	
	90	4800	4700	4000 ₅	4000 ₅	3600 ₂₀	3500 ₁₅	3200 ₂₀	3200 ₃₀	3000 ₃₅	3000 ₅₀	
360x58	10	8100	8000	5700 ₅	5600 ₁₀	4600 ₁₀	4600 ₁₅	4000 ₂₀	3900 ₂₀	3600 ₃₅	3400 ₂₅	
	20	7400	7400	5800 ₅	5700 ₁₀	4700 ₁₀	4700 ₁₅	4000 ₂₅	3900 ₂₀	3600 ₄₀	3400 ₃₀	
	40	6500	6500	5600 ₁₀	5600 ₁₅	4800 ₂₅	4800 ₃₀	4100 ₃₅	4000 ₂₅	3700 ₄₅	3500 ₃₅	
	60	6000	5900	5100 ₁₀	5100 ₁₅	4600 ₁₅	4600 ₂₅	4200 ₄₀	4100 ₃₀	3800 ₅₀	3600 ₄₀	
400x58	90	5400	5400	4600 ₅	4600 ₁₀	4200 ₂₅	4200 ₃₅	3900 ₄₀	3800 ₃₅	3600 ₅₅	3600 ₄₅	
	10	8800	8800	6300 ₁₀	6200 ₁₀	5100 ₂₀	5100 ₂₅	4400 ₂₅	4300 ₃₅	3900 ₃₅	3800 ₃₀	
	20	8000	8000	6300 ₁₀	6200 ₁₀	5100 ₂₀	5100 ₃₀	4400 ₃₀	4400 ₃₅	4000 ₄₀	3800 ₃₀	
	40	7000	7000	6000 ₁₅	6000 ₁₀	5300 ₂₅	5200 ₃₀	4500 ₃₀	4500 ₄₀	4000 ₄₅	3900 ₃₅	
	60	6400	6400	5500 ₁₅	5500 ₂₀	5000 ₃₀	5000 ₃₅	4700 ₃₅	4600 ₄₅	4100 ₅₀	4000 ₄₅	
450x58	90	5900	5900	5000 ₁₅	5000 ₂₀	4500 ₂₅	4500 ₃₀	4200 ₄₅	4200 ₆₀	4000 ₅₅	4000 ₅₀	
	10	9500	9500	7000 ₁₅	7000 ₁₅	5700 ₂₅	5600 ₃₀	4900 ₄₀	4900 ₄₅	4400 ₄₅	4300 ₅₅	
	20	8600	8600	7100 ₁₅	7000 ₂₀	5700 ₂₅	5600 ₃₅	5000 ₄₀	5000 ₅₀	4400 ₄₅	4400 ₆₀	
	40	7600	7600	6600 ₁₅	6600 ₁₅	5900 ₃₀	5800 ₃₅	5100 ₄₅	5000 ₅₅	4500 ₅₀	4500 ₆₀	
	60	7000	7000	6000 ₁₀	6000 ₁₅	5500 ₃₅	5400 ₄₅	5100 ₅₀	5100 ₆₀	4600 ₅₅	4600 ₆₅	
240x75	90	6400	6400	5500 ₂₀	5400 ₂₅	5000 ₃₅	4900 ₄₅	4600 ₄₀	4600 ₅₅	4400 ₆₅	4400 ₈₀	
	10	6100	6000	4300	4200	3500	3300	3000	2900 ₅	2700 ₅	2600 ₁₀	
	20	5900	5900	4300	4200	3500	3400	3000	2900 ₅	2700 ₅	2600 ₁₅	
	40	5100	5200	4400	4400	3600	3400	3100	3000 ₁₀	2700 ₁₅	2700 ₁₅	
	60	4700	4700	4000	4000	3500	3500 ₅	3200 ₅	3000 ₁₀	2800 ₁₅	2700 ₂₀	
	300x75	90	4300	4300	3500	3500	3100	3100 ₅	2800 ₁₀	2800 ₂₀	2600 ₁₅	2600 ₂₅
		10	7500	7500	5300	5200	4300	4200 ₅	3700 ₁₀	3500 ₅	3300 ₅	3100 ₁₅
		20	6900	6800	5300	5300	4300	4200 ₅	3700 ₁₀	3600 ₁₀	3300 ₅	3200 ₁₅
		40	6000	6000	5200	5200	4400 ₅	4300 ₁₀	3800 ₁₅	3700 ₁₀	3400 ₁₀	3200 ₂₀
60		5500	5500	4700	4700	4300 ₅	4300 ₁₀	3900 ₁₅	3700 ₁₅	3500 ₂₅	3300 ₂₀	
400x75	90	5100	5100	4300	4300	3900 ₁₀	3800 ₅	3500 ₂₀	3500 ₁₅	3300 ₁₅	3200 ₂₅	
	10	9100	9100	6800 ₅	6800 ₅	5600 ₁₀	5500 ₁₅	4800 ₂₀	4800 ₂₅	4300 ₂₅	4200 ₃₅	
	20	8300	8300	6900 ₅	6900 ₅	5600 ₁₀	5500 ₂₀	4900 ₂₅	4900 ₃₀	4300 ₂₅	4300 ₃₅	
	40	7400	7400	6400 ₅	6400 ₅	5700 ₁₅	5600 ₂₀	5000 ₂₅	5000 ₃₅	4400 ₃₀	4400 ₄₀	
	60	6800	6800	5800	5800 ₅	5300 ₁₅	5300 ₂₀	5000 ₃₀	4900 ₄₀	4500 ₃₅	4500 ₄₅	
525x75	90	6200	6200	5300 ₅	5300 ₅	4800 ₂₀	4800 ₂₅	4500 ₂₅	4500 ₃₅	4300 ₄₅	4300 ₅₅	
	10	10800	10700	8800 ₁₅	8700 ₁₀	7200 ₂₅	7100 ₂₅	6200 ₃₅	6100 ₃₀	5500 ₃₅	5400 ₄₅	
	20	9900	9900	8900 ₁₅	8800 ₁₅	7200 ₃₀	7200 ₃₅	6200 ₃₅	6100 ₃₀	5600 ₄₅	5500 ₄₅	
	40	8900	8900	7800 ₁₀	7800 ₁₅	7100 ₂₅	7100 ₃₀	6400 ₄₀	6300 ₃₅	5700 ₅₀	5600 ₆₀	
	60	8200	8200	7100 ₁₀	7100 ₁₅	6500 ₂₅	6500 ₂₀	6100 ₄₅	6000 ₄₀	5800 ₅₅	5700 ₆₅	
300x82	90	7600	7600	6500 ₁₀	6500 ₁₀	5900 ₂₅	5900 ₃₀	5500 ₄₀	5500 ₄₅	5200 ₅₅	5200 ₆₅	
	10	7700	7700	5400	5400	4400	4300	3800 ₅	3700 ₅	3400 ₅	3200 ₁₀	
	20	7000	7000	5500	5400	4500	4400	3900 ₅	3700 ₅	3400 ₁₅	3300 ₁₀	
	40	6100	6100	5300	5300	4600	4500 ₅	3900 ₁₀	3800 ₁₀	3500 ₂₀	3300 ₁₅	
	60	5600	5600	4800	4800	4400 ₅	4400 ₅	4000 ₁₅	3900 ₁₀	3600 ₂₅	3400 ₂₀	
	400x82	90	5200	5200	4400	4400	4000 ₅	4000 ₅	3600 ₁₅	3600 ₁₅	3400 ₁₅	3300 ₂₀
		10	9200	9200	7100	7100	5700 ₅	5600 ₁₀	5000 ₁₅	5000 ₂₀	4400 ₂₀	4400 ₂₅
		20	8400	8400	7100	7100 ₅	5800 ₅	5700 ₁₅	5000 ₂₀	5000 ₂₅	4500 ₂₀	4400 ₃₀
		40	7500	7500	6500	6500	5900 ₁₀	5800 ₁₅	5100 ₂₀	5100 ₃₀	4600 ₂₅	4500 ₃₀
60		6900	6900	6000 ₅	5900	5400 ₁₅	5400 ₁₅	5100 ₂₅	5100 ₃₅	4700 ₂₅	4700 ₃₅	

NOTES:

- Sizes in *Italics* are SmartLVL 14
- D = member depth, B = member breadth, NS = not suitable
- End bearing lengths = 35 mm at end supports and 70 mm at internal supports for continuous members. Subscript values indicate the minimum additional bearing length where required to be greater than 35 mm at end supports and 70 mm at internal supports
- Restraint value for slenderness calculations is 1200 mm
- Not all sizes of SmartLVL in this table are stocked in each state. Please check with your supplier before ordering. WA Only.

Continuous span Verandah beam AS 4055 classification C1, C2 and C3

Roof load width (mm)		1500		3000		4500		6000		7500	
Rafter/truss spacing (mm)		600	1200	600	1200	600	1200	600	1200	600	1200
Member size DxB (mm)	Roof mass (kg/m ²)	Maximum recommended Verandah beam span - Continuous span (mm)									
150x35	10	3200	3200	2200	2200	1600	1500	1500	NS	1300	NS
	20	3300	3200	2300	2200	1700	1600	1500	NS	1400	NS
	40	3400	3300	2300	2300	1800	1600	1600	1200	1400	NS
	60	3200	3200	2500	2600	2000	1900	1600	1300	1400	NS
	90	2800	2800	2200	2200	1900	1900	1600	1300 ₅	1400 ₅	NS
170x35	10	3600	3500	2600	2600	2100	1600	1600	1300	1400	NS
	20	3700	3600	2600	2700	2100	1700	1600	1300	1400	NS
	40	3800	3700	2700	2700	2200	2100	1700	1400	1500	NS
	60	3700	3600	2800	2800	2200	2100	1700	1500	1600	1200
	90	3200	3100	2600	2500	2200	2100	1700	1500	1500 ₁₅	1200 ₅
190x35	10	4000	4000	2800	2800	2300	1800	1700	1400	1400	1000
	20	4100	4100	2800	2900	2300	2100	1700	1500	1500	1200
	40	4200	4200	2900	2900	2400	2400	1800	1600	1600	1200
	60	4100	4100	3000	3000	2500	2600	2200 ₅	1700	1600	1300 ₁₀
	90	3600	3600	2900	2800	2500 ₅	2500 ₁₀	2200 ₂₀	1700 ₅	1600 ₁₅	1400 ₁₅
200x35	10	4200	4200	2900	2900	2300	2100	1700	1500	1500	1200
	20	4300	4200	3000	3000	2400	2400	1800	1600	1600	1200
	40	4400	4400	3100	3100	2500	2600	2200	1700	1600	1300
	60	4200	4200	3200	3200	2600	2700	2200 ₁₀	1700	1700	1400 ₅
	90	3800	3800	3000	3000	2600 ₁₀	2600 ₁₀	2300 ₂₅	1700	1700 ₂₀	1400 ₁₀
240x35	10	5000	5000	3500	3400	2800	2800	2400	2400	1900	1900
	20	5000	5100	3500	3500	2900	2900	2500	2500 ₅	1900	1900
	40	5200	5200	3600	3600	3000	3000	2500 ₅	2600 ₁₀	2000 ₅	1600 ₁₀
	60	4800	4900	3800	3700	3100 ₁₀	3100 ₁₀	2700 ₂₅	2700 ₃₀	2300 ₃₀	1900 ₁₅
	90	4400	4400	3600	3600	3100 ₂₅	3100 ₂₅	2700 ₄₅	2700 ₅₀	2200 ₅₅	1900 ₃₀
300x35	10	6100	6000	4300	4300	3500	3300	3000	3000	2600 ₁₅	2600 ₁₀
	20	6200	6100	4300	4300	3600	3400	3000 ₁₀	3000 ₁₀	2500 ₁₅	2500 ₁₅
	40	6300	6300	4500	4500	3600 ₁₅	3600 ₁₅	3100 ₃₀	3100 ₃₀	2600 ₃₅	2800 ₄₅
	60	5700	5700	4700 ₁₀	4600 ₁₀	3800 ₃₀	3700 ₃₀	3300 ₅₀	3200 ₅₀	2900 ₇₀	2900 ₇₀
	90	5200	5200	4400 ₂₀	4300 ₂₀	3800 ₅₅	3700 ₅₅	3300 ₈₀	3200 ₇₅	2900 ₉₅	2900 ₁₀₀
150x42	10	3200	3200	2200	2100	1600	1300	1400	NS	1000	NS
	20	3300	3200	2200	2100	1600	1300	1400	NS	1000	NS
	40	3400	3300	2300	2100	1600	1400	1400	NS	1000	NS
	60	3400	3300	2400	2500	1600	1400	1400	NS	1000	NS
	90	3100	3100	2400	2400 ₅	1600	1400	1400 ₅	NS	1000 ₅	NS
170x42	10	3600	3500	2600	2600	1700	1500	1500	NS	1100	NS
	20	3700	3600	2600	2600	1700	1500	1500	NS	1100	NS
	40	3800	3700	2600	2700	1700	1600	1500	NS	1100	NS
	60	3800	3800	2700	2700	2000	1600 ₅	1600 ₅	1200	1100	NS
	90	3500	3500	2700	2700	2000 ₁₀	1600 ₁₀	1600 ₁₅	1200 ₅	1100 ₅	NS
200x42	10	4200	4200	2900	2900	2200	1700	1600	1300	1400 ₅	NS
	20	4200	4200	3000	2900	2200	1700	1600	1300	1400 ₁₀	NS
	40	4300	4300	3000	2900	2300 ₅	1700	1600 ₅	1400 ₁₀	1500 ₁₅	NS
	60	4400	4400	3100 ₅	2900	2300 ₁₅	1700	1700 ₁₀	1400 ₁₀	1500 ₂₅	1000
	90	4100	4100	3100 ₁₀	2900 ₁₀	2300 ₂₅	1700	1700 ₂₀	1400 ₁₅	1500 ₃₀	1000 ₅
240x42	10	5000	5000	3500	3300	2500 ₅	2800 ₂₀	1900 ₅	1900 ₁₀	1900 ₂₅	1800 ₂₀
	20	5000	5100	3500 ₅	3400	2700 ₁₅	2900 ₂₀	1900 ₁₀	1900 ₁₀	1900 ₃₀	1800 ₂₅
	40	5100	5100	3600 ₁₀	3500 ₁₀	2700 ₂₀	2900 ₃₀	2100 ₂₅	1900 ₁₅	1900 ₄₀	1900 ₄₀
	60	5100	5200	3700 ₂₀	3600 ₁₅	3000 ₄₀	3000 ₄₀	2200 ₄₀	1900 ₂₅	1900 ₄₅	1900 ₅₀
	90	4700	4600	3600 ₂₅	3600 ₂₅	3000 ₅₀	3000 ₅₀	2200 ₅₀	1900 ₃₀	1900 ₆₀	1900 ₆₀

Continuous span Verandah beam AS 4055 classification C1 - C3 (cont'd)

Roof load width (mm)		1500		3000		4500		6000		7500	
Rafter/truss spacing (mm)		600	1200	600	1200	600	1200	600	1200	600	1200
Member size DxB (mm)	Roof mass (kg/m ²)	Maximum recommended Verandah beam span - Continuous span (mm)									
300x42	10	6100	6000	4300 ₁₅	4300 ₁₅	3200 ₃₀	3200 ₃₀	2500 ₃₅	2800 ₄₅	2000 ₃₅	2000 ₃₅
	20	6100	6100	4300 ₂₀	4300 ₂₀	3300 ₃₅	3300 ₃₅	2600 ₄₀	2800 ₅₀	2000 ₄₀	2000 ₄₀
	40	6300	6300	4400 ₃₀	4400 ₃₀	3600 ₅₅	3200 ₄₀	3100 ₈₅	2900 ₇₀	2200 ₅₅	2000 ₅₀
	60	6100 ₅	6100 ₅	4500 ₄₀	4500 ₄₀	3700 ₇₅	3200 ₅₀	3200 ₁₀₀	2900 ₉₀	2400 ₉₅	2000 ₆₀
	90	5500	5500	4500 ₅₀	4500 ₅₀	3700 ₉₅	3200 ₆₅	3200 ₁₁₅	2900 ₁₁₀	2300 ₁₀₀	2000 ₈₅
360x42	10	7200 ₅	7100 ₅	5100 ₃₅	5100 ₃₅	4000 ₅₅	3500 ₄₀	3300 ₈₀	3100 ₆₀	2800 ₉₀	2700 ₈₀
	20	7300 ₅	7200 ₅	5100 ₄₀	5100 ₄₀	4200 ₇₅	3700 ₅₀	3400 ₉₀	3400 ₅₀	2800 ₉₅	2800 ₉₅
	40	7400 ₁₅	7400 ₁₅	5200 ₅₀	5200 ₅₀	4200 ₉₀	4200 ₉₀	3400 ₁₀₀	3300 ₈₅	2800 ₁₁₀	2800 ₁₁₀
	60	6800 ₁₅	6900 ₁₅	5300 ₆₅	5300 ₆₅	4300 ₁₀₅	4400 ₁₀₅	3400 ₁₁₅	3200 ₁₀₅	3200 ₁₄₅	2900 ₁₂₅
	90	6300 ₁₅	6300 ₁₅	5300 ₈₅	5300 ₈₅	4300 ₁₂₀	4300 ₁₂₀	3500 ₁₃₅	3200 ₁₂₀	3100 ₁₆₀	2900 ₁₄₅
400x42	10	7900 ₁₀	7900 ₁₀	5600 ₄₅	5600 ₄₅	4500 ₈₅	4500 ₈₅	3500 ₉₀	3300 ₇₅	2900 ₁₀₀	2900 ₉₅
	20	8000 ₁₅	8000 ₁₅	5600 ₅₀	5600 ₅₀	4600 ₉₀	4500 ₉₀	3500 ₉₅	3300 ₈₅	2900 ₁₀₅	2900 ₁₀₅
	40	7800 ₂₀	8100 ₂₅	5700 ₆₅	5700 ₆₅	4700 ₁₀₅	4600 ₁₀₅	3700 ₁₁₅	3300 ₁₀₀	3300 ₁₃₅	3000 ₁₂₀
	60	7300 ₂₀	7500 ₂₀	5900 ₉₀	5800 ₈₅	4800 ₁₂₀	4600 ₁₂₀	4000 ₁₄₅	3400 ₁₁₅	3300 ₁₅₀	3000 ₁₄₀
	90	6700 ₂₀	6800 ₂₀	5800 ₁₀₀	5800 ₁₀₀	4800 ₁₄₀	4600 ₁₃₀	4000 ₁₆₅	3400 ₁₃₀	3300 ₁₇₀	3000 ₁₅₅
150x58	10	3700	3600	2600	2600	2100	1900	1600	1300	1400	NS
	20	3700	3600	2600	2700	2100	2000	1600	1300	1500	NS
	40	3800	3700	2700	2700	2200	2000	1600	1400	1500	NS
	60	3900	3800	2700	2700	2200	2100	1600	1500	1500	NS
	90	3400	3400	2700	2700	2200	2100	1600	1500	1500	NS
170x58	10	4100	4100	2900	2900	2300	2100	1700	1500	1600	1200
	20	4100	4100	2900	2900	2300	2100	1700	1600	1600	1200
	40	4200	4200	3000	2900	2400	2500	2000	1600 ₅	1600	1300
	60	4300	4300	3000	3000	2500	2600	2100 ₅	1600 ₅	1600	1300 ₁₀
	90	3900	3900	3000	3000	2500	2600 ₅	2100 ₁₀	1600 ₅	1600 ₅	1300 ₁₅
200x58	10	4700	4700	3400	3300	2700	2700	2200	1700	1700	1400
	20	4800	4800	3400	3300	2800	2800	2300	1700	1700	1400
	40	4900	4900	3400	3400	2800	2800	2300 ₅	1700	1700	1500
	60	4800	4900	3500	3400	2900 ₅	2900 ₅	2300 ₁₅	2100 ₅	1800 ₁₀	1600 ₁₅
	90	4400	4400	3500	3400	2800 ₁₀	2800 ₁₅	2300 ₂₀	2100 ₁₀	1800 ₁₅	1600 ₁₀
240x58	10	5600	5600	4000	3900	3200	3100	2700 ₁₀	2800 ₁₀	2200 ₁₅	1900
	20	5700	5600	4000	4000	3300 ₅	3100	2700 ₁₅	2800 ₁₅	2300 ₁₅	1900
	40	5800	5700	4100	4100	3300 ₁₀	3100 ₅	2800 ₂₅	2900 ₂₅	2500 ₃₀	2600 ₄₀
	60	5500	5600	4100	4100	3400 ₂₀	3300 ₁₅	2900 ₃₀	2900 ₃₀	2500 ₄₀	2700 ₅₀
	90	5000	5100	4100 ₁₀	4100 ₁₀	3400 ₂₅	3300 ₂₅	2900 ₄₀	2900 ₄₀	2500 ₅₀	2700 ₆₅
300x58	10	6900	6900	4800	4800	3900 ₁₅	3900 ₁₅	3400 ₃₀	3200 ₂₅	3000 ₄₅	2900 ₄₀
	20	6900	6900	4900 ₅	4900 ₅	4000 ₂₀	4000 ₂₀	3500 ₃₅	3400 ₂₅	3100 ₅₀	3000 ₄₅
	40	7000	7100	5000 ₁₀	5000 ₁₀	4100 ₃₀	4100 ₃₀	3500 ₄₅	3200 ₄₀	3100 ₆₅	3100 ₆₀
	60	6500	6500	5100 ₂₀	5100 ₂₀	4100 ₄₀	4100 ₄₀	3600 ₅₅	3200 ₄₅	3200 ₈₅	3100 ₈₀
	90	5900	6000	5000 ₂₅	5100 ₂₅	4100 ₅₀	4100 ₅₀	3600 ₈₅	3200 ₆₀	3200 ₁₀₀	3100 ₉₅
360x58	10	8100	8100	5700 ₁₅	5700 ₁₅	4700 ₃₅	4600 ₃₀	4000 ₅₀	4000 ₅₀	3400 ₆₅	3200 ₅₀
	20	8200	8200	5800 ₂₀	5700 ₁₅	4700 ₄₀	4600 ₃₅	4100 ₅₅	4100 ₆₀	3500 ₇₅	3300 ₆₀
	40	7800	8100	5900 ₂₅	5800 ₂₅	4800 ₅₀	4700 ₅₀	4100 ₈₀	4100 ₈₀	3600 ₉₀	3300 ₈₀
	60	7200	7400	6000 ₃₅	6000 ₃₅	4900 ₆₅	4900 ₆₅	4200 ₉₅	4200 ₉₅	3800 ₁₁₅	3400 ₉₅
	90	6700	6800	5800 ₄₀	5800 ₄₀	4900 ₈₅	4800 ₈₅	4200 ₁₁₀	4200 ₁₁₀	3800 ₁₃₀	3400 ₁₁₀
400x58	10	8900	8900	6300 ₂₅	6300 ₂₅	5100 ₄₅	5100 ₄₅	4400 ₆₅	4400 ₇₀	4000 ₉₅	3400 ₆₀
	20	9000	9000	6300 ₂₅	6300 ₂₅	5200 ₅₀	5200 ₅₀	4500 ₈₅	4500 ₈₅	4000 ₁₀₀	3400 ₇₀
	40	8300	8700	6500 ₃₅	6500 ₄₀	5300 ₆₅	5300 ₇₀	4600 ₉₅	4500 ₁₀₀	4100 ₁₁₅	3500 ₉₀
	60	7700	8000	6600 ₄₅	6600 ₄₅	5400 ₉₀	5400 ₉₀	4700 ₁₁₀	4600 ₁₁₀	4200 ₁₃₅	3700 ₁₁₀
	90	7200	7300	6200 ₅₀	6200 ₅₀	5300 ₁₀₀	5300 ₁₀₀	4600 ₁₂₅	4600 ₁₂₅	4100 ₁₅₀	3600 ₁₂₅

Continuous span Verandah beam AS 4055 classification C1, C2 and C3 (Cont'd)

Roof load width (mm)		1500		3000		4500		6000		7500	
Rafter/truss spacing (mm)		600	1200	600	1200	600	1200	600	1200	600	1200
Member size DxB (mm)	Roof mass (kg/m ²)	Maximum recommended Verandah beam span - Continuous span (mm)									
450x58	10	9900 ₅	9900 ₅	7000 ₃₅	7000 ₃₅	5700 ₆₀	5700 ₆₀	4900 ₉₀	4900 ₉₀	4400 ₁₁₀	4100 ₁₀₀
	20	10000 ₅	10000 ₅	7100 ₄₀	7000 ₄₀	5800 ₇₅	5700 ₇₀	5000 ₁₀₀	4900 ₉₅	4400 ₁₂₀	4400 ₁₁₅
	40	8900 ₅	9500 ₁₀	7200 ₅₀	7200 ₅₀	5900 ₉₀	5800 ₉₀	5100 ₁₁₅	5100 ₁₂₅	4500 ₁₂₅	4500 ₁₂₅
	60	8300 ₅	8700 ₅	7300 ₆₀	7300 ₆₀	6000 ₁₀₅	5900 ₁₀₅	5200 ₁₃₀	5200 ₁₃₀	4600 ₁₅₅	4500 ₁₅₀
	90	7700 ₅	8000 ₅	6800 ₆₅	6800 ₇₀	5900 ₁₂₀	5900 ₁₂₀	5100 ₁₄₅	5100 ₁₄₅	4600 ₁₇₅	4500 ₁₇₀
240x75	10	6100	6100	4300	4300	3500	3400	3000	3000	2700 ₅	2700 ₁₀
	20	6200	6100	4400	4300	3500	3500	3100	3000	2700 ₁₀	2800 ₁₀
	40	6300	6300	4400	4400	3600	3500	3100 ₁₀	3100 ₅	2800 ₁₅	2800 ₂₀
	60	5900	5900	4500	4500	3700 ₅	3600	3200 ₁₅	3200 ₁₅	2800 ₂₅	2800 ₃₀
	90	5400	5300	4500	4500	3700 ₁₀	3600 ₁₀	3200 ₂₅	3100 ₂₀	2800 ₃₅	2800 ₃₅
300x75	10	7500	7500	5300	5300	4300	4300	3700 ₁₅	3600 ₁₅	3300 ₂₅	3200 ₂₅
	20	7600	7600	5300	5300	4300 ₅	4300 ₅	3800 ₂₀	3700 ₁₅	3400 ₃₀	3300 ₂₅
	40	7300	7500	5400	5400	4400 ₁₅	4400 ₁₅	3800 ₂₅	3800 ₂₅	3400 ₄₀	3200 ₃₅
	60	6800	6900	5600 ₅	5600 ₅	4500 ₂₀	4500 ₂₀	3900 ₃₅	3900 ₃₅	3500 ₅₀	3300 ₄₀
400x75	90	6300	6300	5400 ₁₀	5400 ₁₀	4500 ₃₀	4500 ₃₀	3900 ₄₅	3800 ₄₅	3500 ₆₀	3300 ₅₅
	10	9800	9700	6900 ₁₀	6900 ₁₀	5600 ₂₅	5600 ₂₅	4900 ₄₀	4800 ₄₀	4300 ₅₅	4300 ₅₅
	20	9600	9800	6900 ₁₀	6900 ₁₀	5600 ₃₀	5600 ₃₀	4900 ₄₅	4800 ₄₅	4400 ₆₅	4400 ₆₅
	40	8600	9200	7100 ₂₀	7000 ₂₀	5800 ₄₀	5700 ₄₀	5000 ₆₀	4900 ₆₀	4500 ₉₀	4500 ₉₀
525x75	60	8100	8500	7100 ₂₅	7200 ₃₀	5900 ₅₀	5800 ₅₀	5100 ₈₅	5100 ₈₅	4500 ₁₀₀	4500 ₁₀₀
	90	7500	7800	6600 ₃₀	6600 ₃₀	5800 ₆₅	5800 ₆₅	5000 ₉₅	5000 ₉₅	4500 ₁₁₅	4500 ₁₁₅
	10	12000	12000	8800 ₃₀	8800 ₃₀	7200 ₅₅	7100 ₅₅	6200 ₉₀	6100 ₉₀	5500 ₁₀₅	5500 ₁₀₅
	20	11400	12000 ₅	8900 ₃₅	8900 ₃₅	7300 ₆₅	7200 ₆₅	6200 ₉₅	6200 ₉₅	5600 ₁₁₅	5600 ₁₁₅
	40	10200	11100	9000 ₄₅	9100 ₅₀	7400 ₉₀	7300 ₉₀	6400 ₁₁₀	6400 ₁₁₀	5700 ₁₃₀	5700 ₁₃₀
300x82	60	9500	10200	8400 ₄₅	8900 ₅₅	7500 ₁₀₀	7500 ₁₀₀	6500 ₁₂₅	6500 ₁₂₅	5800 ₁₅₀	5800 ₁₅₀
	90	8800	9400	7800 ₅₀	8100 ₅₅	7200 ₁₁₀	7400 ₁₁₅	6400 ₁₄₀	6400 ₁₄₀	5800 ₁₆₅	5700 ₁₆₅
	10	7700	7700	5400	5400	4400	4400	3800 ₁₀	3800 ₁₀	3400 ₂₀	3300 ₁₅
	20	7800	7800	5500	5500	4500	4500	3900 ₁₅	3800 ₁₀	3500 ₂₅	3300 ₂₀
	40	7400	7600	5600	5600	4600 ₁₀	4500 ₅	4000 ₂₀	3900 ₂₀	3500 ₃₅	3400 ₃₀
400x82	60	6900	7000	5700	5700	4700 ₁₅	4600 ₁₅	4000 ₃₀	4000 ₃₀	3600 ₄₀	3500 ₄₀
	90	6400	6400	5500 ₅	5500 ₅	4600 ₂₅	4600 ₂₅	4000 ₄₀	4000 ₄₀	3600 ₅₅	3500 ₅₀
	10	10100	10100	7100 ₅	7000 ₅	5800 ₂₀	5700 ₂₀	5000 ₃₅	4900 ₃₅	4400 ₄₅	4500 ₅₀
	20	9800	10200	7200 ₁₀	7100 ₅	5800 ₂₅	5800 ₂₅	5000 ₄₀	5000 ₄₀	4500 ₅₅	4500 ₅₅
	40	8800	9400	7300 ₁₅	7200 ₁₅	6000 ₃₅	5900 ₃₅	5100 ₅₀	5100 ₅₀	4600 ₇₅	4600 ₇₅
300x82	60	8200	8700	7200 ₂₀	7400 ₂₀	6100 ₄₅	6000 ₄₅	5200 ₆₅	5200 ₆₅	4700 ₉₀	4600 ₉₀
	90	7600	7900	6700 ₂₀	6800 ₂₀	6000 ₅₅	5900 ₅₅	5200 ₈₅	5200 ₈₅	4600 ₁₀₅	4600 ₁₀₅

NOTES:

- Sizes in *Italics* are SmartLVL 14
- D = member depth, B = member breadth, NS = not suitable.
- End bearing lengths = 35 mm at end supports and 70 mm at internal supports for continuous members. Subscript values indicate the minimum additional bearing length where required to be greater than 35 mm at end supports and 70 mm at internal supports
- Restraint value for slenderness calculations is 1200 mm
- Not all sizes of SmartLVL in this table are stocked in each state. Please check with your supplier before ordering. WA only

Hip rafter - sheet and tile roof

AS 4055 wind classification N1 - N3 and C1 - C3

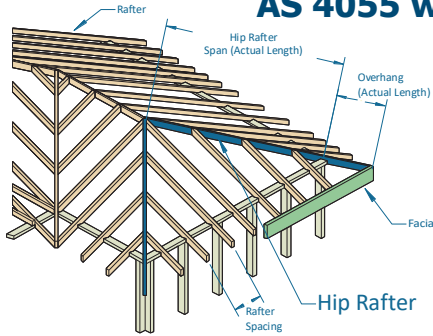

EXAMPLE:

wind speed = N3
 roof load = 40 kg/m² (sheet roof)
 hip rafter span = 4500 mm (single span)
 rafter spacing = 600 mm

Enter column at (N1-N3) wind speed, 600 mm rafter spacing and read down to span equal to or greater than 4500 mm for a 40 kg/m² roof load

ADOPT: SmartLVL 15 - 240x42

AS 4055 wind category		N1 - N3				C1 - C3			
Maximum Rafter spacing (mm)		600		1200		600		1200	
Member size DxB (mm)	Roof mass (kg/m ²)	Maximum hip rafter and overhang span - single span (mm)							
		span	O/H	span	O/H	span	O/H	span	O/H
130x42	40	3200	725	3200	600	3050	675	3050	450
	90	2600	700	2600	550	2600	700	2600	500
140x42	40	3350	800	3350	625	3150	700	3150	475
	90	2750	750	2750	600	2750	750	2750	550
150x42	40	3550	875	3550	650	3300	750	3300	525
	90	2900	800	2900	625	2900	800	2900	575
170x42	40	3900	1050	3900	725	3550	825	3550	575
	90	3200	900	3200	725	3200	900	3200	625
190x42	40	4200	1150	4200	800	3800	900	3800	625
	90	3500	1000	3500	800	3500	1000	3500	700
200x42	40	4400	1200	4400	825	3950	950	3950	650
	90	3600	1050	3600	825	3600	1050	3600	725
240x42	40	5000	1400	5000	975	4400	1100	4400	750
	90	4150	1250	4150	1000	4150	1225	4150	825
300x42	40	5850	1700	5850	1175	5000 ₁₀	1325	5000 ₁₀	900
	90	4900	1550	4900	1225	4900 ₁₅	1475	4900 ₁₅	1000
360x42	40	6500 ₅	1975	6500 ₅	1350	5600 ₂₀	1550	5600 ₂₀	1050
	90	5600 ₅	1825	5600 ₁₀	1475	5600 ₃₀	1700	5600 ₃₀	1175
400x42	40	6950 ₁₀	2150	6950 ₁₀	1475	5950 ₃₀	1675	5950 ₃₀	1150
	90	6050 ₁₀	1950	6050 ₂₀	1625	5950 ₄₀	1875	5950 ₃₅	1275
130x58	40	3450	825	3450	700	3250	800	3250	550
	90	2850	775	2850	625	2850	775	2850	600
150x58	40	3800	1025	3800	775	3550	900	3550	625
	90	3150	875	3150	700	3150	875	3150	675
170x58	40	4200	1225	4200	875	3800	975	3800	675
	90	3450	975	3450	800	3450	975	3450	750
200x58	40	4750	1450	4750	1000	4200	1125	4200	775
	90	3900	1150	3900	925	3900	1150	3900	850
240x58	40	5400	1675	5400	1150	4700	1300	4700	900
	90	4450	1375	4450	1100	4450	1375	4450	1000
300x58	40	6200	2025	6200	1400	5350 ₅	1575	5350 ₅	1075
	90	5300	1700	5300	1375	5300 ₁₀	1700	5300 ₅	1200
360x58	40	6950	2250	6950	1625	5950 ₁₀	1850	5950 ₁₀	1250
	90	6050	1950	6050	1625	5950 ₂₀	1950	5950 ₂₀	1400
400x58	40	7400 ₅	2400	7400 ₅	1750	6350 ₂₀	2000	6350 ₂₀	1375
	90	6450	2125	6450 ₅	1800	6350 ₂₅	2050	6350 ₂₅	1525
450x58	40	7950 ₁₀	2600	7950 ₁₀	1950	6850 ₂₅	2225	6850 ₂₅	1500
	90	6900 ₁₀	2275	6900 ₁₀	2025	6850 ₃₅	2250	6850 ₃₅	1675
240x75	40	5750	1850	5750	1325	4950	1500	4950	1025
	90	4750	1500	4750	1200	4750	1500	4750	1150
300x75	40	6550	2150	6550	1600	5650	1825	5650	1250
	90	5600	1800	5600	1475	5600	1800	5600	1375
400x75	40	7800	2550	7800	2025	6700 ₁₀	2200	6700 ₁₀	1575
	90	6750	2225	6750	1975	6700 ₂₀	2200	6700 ₁₅	1750
525x75	40	9150 ₁₀	3000	9150 ₁₀	2550	7900 ₃₀	2600	7900 ₃₀	1975
	90	7950 ₁₀	2600	7950 ₁₀	2550	7900 ₄₀	2600	7900 ₃₅	2200
300x82	40	6800	1850	6900	1850	6200	1550	6200	1500
	90	5700	1400	5700	1400	5700	1400	5700	1400
400x82	40	8500	2150	8500	2150	6300 ₆₅	1600	6300 ₆₅	1550
	90	7000	1650	7000	1650	6000 ₁₈₅	1300	6000 ₁₈₅	1300

NOTES:

- Sizes in *Italics* are SmartLVL 14
- D = member depth, B = member breadth, NS = not suitable.
- The above table was based on a batten spacing of 900 mm
- Minimum backspan = 200 % of overhang, Maximum birdsmouth depth = 30 % of depth
- End bearing length = 35 at end supports. Subscript values indicate the minimum additional bearing length where required to be greater than 35 mm at end support
- Construction loads shall not be applied to overhangs until a 190 x 19 mm (min) timber fascia or other fascia of equivalent stiffness is rigidly and permanently attached to the end of rafter overhangs
- Not all sizes of SmartLVL in this table are stocked in each state. Please check with your supplier before ordering. WA only

Underpurlins - sheet and tiled roof AS 4055 wind classification N1 - N3

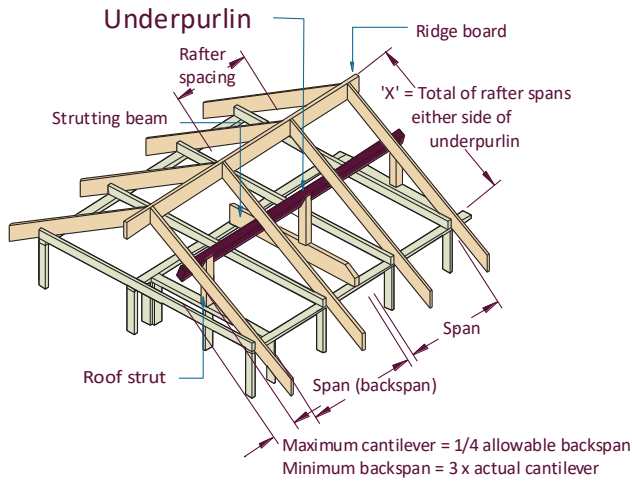

EXAMPLE:

wind speed = N3
rafter spacing = 1200 mm
roof load = 20 kg/m² (sheet roof)
underpurlin span = 3500 mm (single span)

'X' (total of rafter span) = 5400 mm
roof load width = 'X' / 2 = 5400 / 2 = 2700 mm

Enter single span table at 2700 mm roof load width column, 1200 rafter spacing and read down to span equal to or greater than 3500 mm in a 20 kg/m² row

ADOPT:

SmartLVL 15 - 170x58

RLW = X/2 where ridge is strutted

Roof load width (mm)		1800		2700		3600		1800		2700		3600	
rafter spacing (mm)		600	1200	600	1200	600	1200	600	1200	600	1200	600	1200
Member size DxB (mm)	Roof mass (kg/m ²)	Single span						Continuous span					
		Maximum recommended Underpurlin span (mm)											
90x35	20	2000	2000	1700	1400	1500	1000	2200	2200	1700	1700	1500	1300
	60	1400	1200	1200	1000	1100	NS	1800	1800	1600	1500	1400	1200
120x35	20	2700	2700	2300	2200	1900	1700	2800	2900	2300	2500	2000	1900
	60	1800	1800	1600	1500	1500	1300	2500	2500	2200	2100	1800	1700
130x35	20	2900	2900	2500	2400	2100	2000	3100	3100	2500	2600	2200	2100
	60	2000	2000	1700	1700	1600	1500	2700	2700	2300	2300	2000	1800
90x42	20	2200	2200	1900	1900	1700	1700	2900	2900	2600	2600	2300	2300
	60	1500	1400	1300	1100	1200	NS	2000	2000	1800	1700	1600	1400
120x42	20	2900	2900	2500	2600	2300	2300	3900	3800	3400	3400	3100	3100
	60	2000	2000	1700	1700	1600	1500	2700	2700	2400	2400	2100	2100
130x42	20	3100	3100	2700	2800	2500	2600	4200	4200	3700	3700	3400	3300
	60	2200	2200	1900	1900	1700	1700	2900	2900	2600	2600	2300	2300
140x42	20	3400	3300	2900	2900	2700	2700	4500	4500	4000	3900	3600	3600
	60	2300	2400	2100	2000	1800	1800	3200	3100	2800	2700	2500	2500
150x42	20	3600	3600	3200	3100	2900	2900	4800	4900	4300	4200	3900	3900
	60	2500	2600	2200	2200	2000	2000	3400	3400	3000	3000	2700	2700
90x58	20	2400	2500	2100	2100	1900	1900	3200	3200	2800	2800	2600	2600
	60	1600	1600	1500	1300	1300	1100	2200	2200	2000	1900	1800	1800
130x58	20	3400	3400	3000	3000	2800	2800	4600	4600	4100	4100	3700	3700
	60	2400	2500	2100	2100	1900	1900	3300	3200	2900	2900	2600	2600
150x58	20	4000	3900	3500	3500	3200	3200	5300	5300	4700	4700	4300	4300
	60	2800	2800	2500	2500	2200	2200	3800	3800	3300	3300	3000	3000
170x58	20	4500	4500	4000	3900	3600	3600	6000	6000	5300	5300	4900	4900
	60	3200	3100	2800	2800	2500	2600	4300	4300	3700	3700	3400	3400
200x58	20	5200	5300	4600	4600	4300	4200	6900	7000	6200	6200	5700	5700
	60	3700	3700	3300	3200	3000	3000	5000	5100	4400	4400	4000	4000
240x75	20	6700	6700	6000	6000	5500	5500	8300	9000	7600	8100	7100	7400
	60	4900	4900	4300	4300	3900	3900	6500	6500	5800	5800	5200	5300
300x75	20	8200	8200	7400	7400	6800	6800	9800	11000	8900	9900	8400	9100
	60	6000	6000	5300	5300	4900	4900	7600	8200	7000	7100	6500 ₁₀	6500 ₁₀
300x82	20	8400	8400	7600	7600	7000	7000	10000	11300	9100	10100	8600	9300
	60	6200	6200	5500	5500	5000	5000	7800	8400	7100	7400	6600 ₁₀	6700 ₁₀

NOTES:

- Sizes in *Italics* are SmartLVL 14
- D = member depth, B = member breadth, NS = not suitable.
- Maximum cantilever = 1/4 allowable backspan
- Minimum backspan = 3 x actual cantilever
- End bearing length = 45 at end supports and 45 mm at internal for continuous member. Subscript values indicate the minimum additional bearing length where required to be greater than 45 mm at end support and 45 mm at internal for continuous member
- Not all sizes of SmartLVL in this table are stocked in each state. Please check with your supplier before ordering. WA only

Underpurlins - sheet and tiled roof AS 4055 wind classification C1, C2 and C3

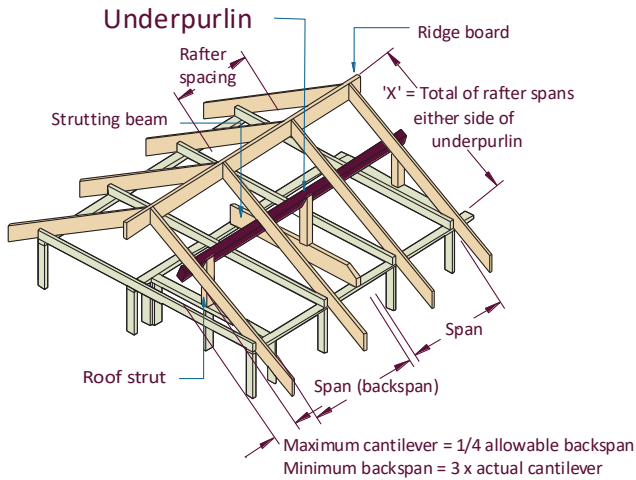

EXAMPLE:

wind speed = C3
rafter spacing = 1200 mm
roof load = 20 kg/m² (sheet roof)
underpurlin span = 3500 mm (single span)

'X' (total of rafter span) = 5400 mm
roof load width = 'X' / 2 = 5400 / 2 = 2700 mm

Enter single span table at 2700 mm roof load width column, 1200 rafter spacing and read down to span equal to or greater than 3500 mm in a 20 kg/m² row

ADOPT:

SmartLVL 15 - 200x58

RLW = X/2 where ridge is struttred

Roof load width (mm)		1800		2700		3600		1800		2700		3600	
Rafter spacing (mm)		600	1200	600	1200	600	1200	600	1200	600	1200	600	1200
Member size DxB (mm)	Roof mass (kg/m ²)	Single span						Continuous span					
		Maximum recommended Underpurlin span (mm)											
90x35	20	1700	1300	1400	NS	1200	NS	1700	1700	1400	1200	1300	NS
	60	1400	1200	1200	NS	1100	NS	1800	1800	1400	1200	1300	NS
120x35	20	2300	2200	1800	1500	1500	1100	2300	2300	1800	1700	1500	1400
	60	1800	1800	1600	1500	1500	1200	2300	2500	1900	1700	1500	1400
130x35	20	2500	2400	1900	1700	1600	1300	2500	2600	2000	1800	1600	1500
	60	2000	2000	1700	1700	1600	1300	2500	2600	2000	2000	1700	1500
90x42	20	1800	1500	1400	NS	1300	NS	1800	1800	1400	1000	1000	NS
	60	1500	1400	1300	1100	1200	NS	2000	1900	1400	1400	1400	NS
120x42	20	2400	2300	1900	1700	1600	NS	2500	2600	2000	1500	1500	1300
	60	2000	2000	1700	1700	1600	1400	2600	2600	2100	2000	1500	1500
130x42	20	2600	2600	2100	2000	1800	1300	2600	2700	2100	2000	1500	1400
	60	2200	2200	1900	1900	1700	1500	2800	2800	2200	2100	1700	1500
140x42	20	2800	2700	2300	2100	1900	1500	2800	2800	2300	2100	1700	1600
	60	2300	2400	2100	2000	1800	1800	2900	2900	2400	2500 ₁₀	2100 ₁₅	1600
150x42	20	3000	2900	2400	2300	2000	1600	3000	3000	2400	2600	2100 ₁₀	1600
	60	2500	2600	2200	2200	2000	2000	3200	3100	2600 ₁₀	2600 ₁₅	2200	1600
90x58	20	2100	1900	1600	1300	1400	NS	2100	2000	1700	1700	1400	1200
	60	1600	1600	1500	1300	1300	1000	2200	2200	1800	1800	1500	1400
130x58	20	2900	2800	2400	2300	2000	1900	2900	2900	2400	2500	2100	2000
	60	2400	2500	2100	2100	1900	1900	3100	3100	2600	2600	2200	2100
150x58	20	3400	3200	2700	2600	2400	2200	3400	3300	2800	2800	2400	2500
	60	2800	2800	2500	2500	2200	2200	3500	3500	2900	2900	2500 ₁₀	2600 ₁₀
170x58	20	3800	3600	3000	2900	2600	2600	3800	3700	3100	3100	2700	2700 ₅
	60	3200	3100	2800	2800	2500	2600	4000	4000	3300 ₅	3200 ₅	2800 ₁₅	2800 ₁₅
200x58	20	4400	4300	3600	3400	3100	2900	4400	4400	3600	3500	3100 ₁₀	3100 ₁₀
	60	3700	3700	3300	3200	3000	3000	4600	4600	3800 ₁₅	3700 ₁₅	3300 ₂₅	3200 ₂₅
240x75	20	5600	5600	4600	4600	4000	3800	5700	5600	4600	4600	4000 ₁₀	4000 ₁₀
	60	4900	4900	4300	4300	3900	3900	5900	5900	4800 ₁₅	4800 ₁₅	4200 ₂₅	4200 ₂₅
300x75	20	6900	6900	5600	5500	4900	4800	7000 ₅	6900	5700 ₁₅	5600 ₁₅	4900 ₂₅	4900 ₂₅
	60	6000	6000	5300	5300	4900	4900	7200 ₁₅	7200 ₁₅	5900 ₃₀	5900 ₃₀	5100 ₄₀	5100 ₄₀
300x82	20	7200	7100	5800	5700	5000	5000	7200	7100	5800 ₁₀	5800 ₁₀	5000 ₂₀	5100 ₂₀
	60	6200	6200	5500	5500	5000	5000	7400 ₁₀	7400 ₁₀	6100 ₂₅	6000 ₂₅	5300 ₃₅	5300 ₃₅

NOTES:

- Sizes in *Italics* are SmartLVL 14
- D = member depth, B = member breadth, NS = not suitable.
- Maximum cantilever = 1/4 allowable backspan
- Minimum backspan = 3 x actual cantilever
- End bearing length = 45 at end supports and 45 mm at internal for continuous member. Subscript values indicate the minimum additional bearing length where required to be greater than 45 mm at end support and 45 mm at internal for continuous member
- Not all sizes of SmartLVL in this table are stocked in each state. Please check with your supplier before ordering. WA only

Hanging beam supporting ceiling loads only AS 4055 classification N1 - N3

ceiling mass - 20 kg/m²

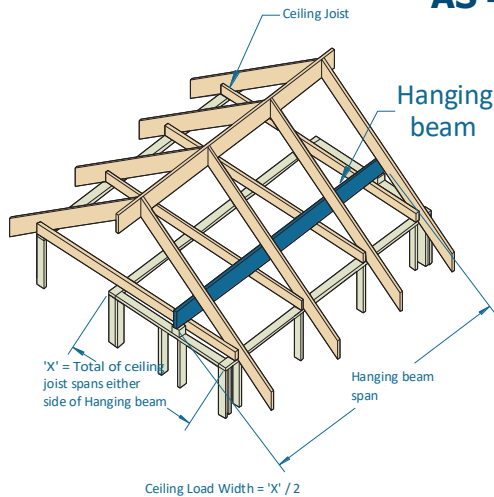

EXAMPLE:

wind speed = N3
hanging beam span = 4200 mm
X = 5000 mm

ceiling load width = X/2 = 5000/2 = 2500 mm

Enter column at 3000 mm ceiling load width & read down to a span greater than or equal to 4200 mm

ADOPT:

SmartLVL 14 - 2/190x35

Ceiling load width (mm)	1800	2400	3000	3600	4200	4800
Member size DxB (mm)	Maximum recommended Hanging beam span (mm)					
<i>150x35</i>	3400	3050	2800	2600	2450	2300
<i>170x35</i>	3800	3450	3200	2950	2750	2600
<i>190x35</i>	4150	3850	3550	3300	3100	2900
<i>200x35</i>	4300	4000	3750	3450	3250	3050
<i>240x35</i>	4900	4550	4250	4050	3850	3700
<i>2/150x35</i>	4100	3800	3500	3250	3050	2900
<i>2/170x35</i>	4450	4150	3900	3700	3450	3250
<i>2/190x35</i>	4850	4500	4250	4000	3850	3650
<i>2/200x35</i>	5000	4650	4400	4150	4000	3800
<i>2/240x35</i>	5700	5300	5000	4750	4550	4350
<i>150x42</i>	3650	3300	3050	2850	2650	2500
<i>170x42</i>	4000	3700	3450	3200	3000	2850
<i>200x42</i>	4500	4200	3900	3700	3550	3350
<i>240x42</i>	5150	4750	4500	4250	4050	3900
<i>300x42</i>	6050	5600	5300	5000	4800	4600
<i>2/150x42</i>	4250	3950	3750	3500	3300	3150
<i>2/170x42</i>	4650	4350	4100	3900	3700	3550
<i>2/200x42</i>	5200	4850	4600	4350	4200	4000
<i>2/240x42</i>	5950	5550	5250	5000	4750	4600
<i>2/300x42</i>	6900	6500	6150	5850	5600	5400
<i>2/360x42</i>	7800	7350	7000	6650	6400	6150
<i>2/400x42</i>	8400	7900	7500	7200	6900	6650
<i>150x58</i>	3950	3650	3350	3150	2950	2800
<i>170x58</i>	4300	4000	3750	3550	3350	3150
<i>200x58</i>	4850	4500	4250	4000	3850	3700
<i>240x58</i>	5500	5150	4850	4600	4400	4200
<i>300x58</i>	6450	6000	5650	5400	5150	4950
<i>360x58</i>	7300	6850	6450	6150	5900	5650
<i>400x58</i>	7850	7350	6950	6650	6350	6100
<i>450x58</i>	8500	8000	7550	7200	6900	6650
<i>240x75</i>	5800	5400	5100	4850	4650	4450
<i>300x75</i>	6750	6350	6000	5700	5450	5250
<i>400x75</i>	8250	7750	7350	7000	6700	6450
<i>525x75</i>	9850	9350	8900	8500	8150	7850
<i>300x82</i>	6900	6450	6100	5800	5550	5350
<i>400x82</i>	8350	7900	7500	7150	6850	6600

NOTES:

- Sizes in Italics are SmartLVL 14
- D = member depth, B = member breadth, NS = not suitable.
- The above table was based on a maximum ceiling mass of 20 kg/m².
- Minimum bearing length = 70 mm at end supports.
- Restraint value for slenderness calculations is 1500 mm
- Not all sizes of SmartLVL in this table are stocked in each state. Please check with your supplier before ordering. WA only

Hanging beam supporting ceiling loads only AS 4055 classification C1 - C3

ceiling mass - 20 kg/m²

Ceiling load width (mm)	1800	2400	3000	3600	4200	4800
Member size DxB (mm)	Maximum Hanging beam span (mm)					
<i>150x35</i>	3100	2700	2400	2200	2000	1850
<i>170x35</i>	3450	3000	2700	2450	2250	2100
<i>190x35</i>	3850	3300	2950	2700	2500	2300
<i>200x35</i>	4000	3500	3100	2850	2600	2450
<i>240x35</i>	4750	4100	3650	3350	3100	2850
<i>2/150x35</i>	4100	3800	3500	3250	3050	2850
<i>2/170x35</i>	4450	4150	3900	3700	3400	3150
<i>2/190x35</i>	4850	4500	4250	4000	3750	3500
<i>2/200x35</i>	5000	4650	4400	4150	3950	3650
<i>2/240x35</i>	5700	5300	5000	4750	4550	4300
<i>150x42</i>	3650	3300	3050	2800	2550	2400
<i>170x42</i>	4000	3700	3400	3100	2850	2700
<i>200x42</i>	4500	4200	3900	3600	3300	3100
<i>240x42</i>	5150	4750	4500	4250	3900	3650
<i>300x42</i>	6050	5600	5300	5000	4800	4450
<i>2/150x42</i>	4250	3950	3750	3500	3300	3150
<i>2/170x42</i>	4650	4350	4100	3900	3700	3550
<i>2/200x42</i>	5200	4850	4600	4350	4200	4000
<i>2/240x42</i>	5950	5550	5250	5000	4750	4600
<i>2/300x42</i>	6900	6500	6150	5850	5600	5400
<i>2/360x42</i>	7800	7350	7000	6650	6400	6150
<i>2/400x42</i>	8400	7900	7500	7200	6900	6650
<i>150x58</i>	3950	3650	3350	3150	2900	2700
<i>170x58</i>	4300	4000	3750	3500	3250	3000
<i>200x58</i>	4850	4500	4250	4000	3750	3500
<i>240x58</i>	5500	5150	4850	4600	4400	4100
<i>300x58</i>	6450	6000	5650	5400	5150	4950
<i>360x58</i>	7300	6850	6450	6150	5900	5650
<i>400x58</i>	7850	7350	6950	6650	6350	6100
<i>450x58</i>	8500	8000	7550	7200	6900	6650
<i>240x75</i>	5800	5400	5100	4850	4650	4450
<i>300x75</i>	6750	6350	6000	5700	5450	5250
<i>400x75</i>	8250	7750	7350	7000	6700	6450
<i>525x75</i>	9850	9350	8900	8500	8150	7850
<i>300x82</i>	6900	6450	6100	5800	5550	5350
<i>400x82</i>	8350	7900	7500	7150	6850	6600

NOTES:

- Sizes in *Italics* are SmartLVL 14
- D = member depth, B = member breadth, NS = not suitable.
- The above table was based on a maximum ceiling mass of 20 kg/m²
- Minimum bearing length = 70 mm at end supports.
- Restraint value for slenderness calculations is 1500 mm
- Not all sizes of SmartLVL in this table are stocked in each state. Please check with your supplier before ordering. WA only

Counter beam supporting hanging beam AS 4055 classification N1, N2 and N3

ceiling mass - 20 kg/m²

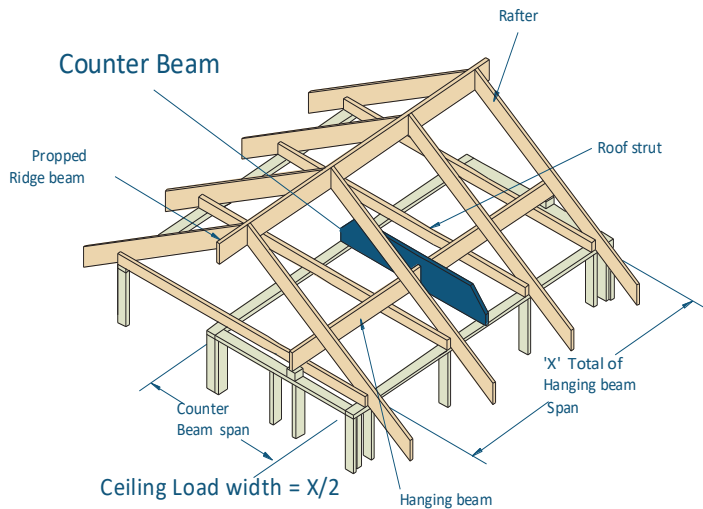

EXAMPLE:

wind speed = N3
total of hanging beam span = 6400 mm
ceiling load width = 'X' / 2 = 6400 / 2 = 3200 mm

counter beam span = 4500 mm

Enter column at 3600 mm ceiling load width and read down to a span greater than or equal to 4500 mm

ADOPT:

SmartLVL 14 - 2/200x35

Ceiling load width (mm)	600	1800	2400	3000	3600	4200	4800	5400	6600
Member size DxB (mm)	Maximum recommended Counter beam span (mm)								
<i>150x35</i>	4150	3850	3500	3300	3100	2950	2800	2700	2550
<i>170x35</i>	4700	4350	3950	3700	3500	3350	3200	3100	2900
<i>200x35</i>	5500	4900	4600	4350	4100	3900	3750	3600	3400
<i>240x35</i>	6600	5600	5250	5000	4800	4650	4500	4300	4050
<i>2/150x35</i>	5200	4650	4350	4050	3850	3650	3500	3400	3200
<i>2/170x35</i>	5900	5050	4800	4550	4350	4150	3950	3850	3600
<i>2/200x35</i>	6850	5700	5350	5100	4900	4750	4600	4500	4200
<i>2/240x35</i>	7650	6450	6100	5800	5600	5400	5250	5150	4900
<i>150x42</i>	5250	4150	3800	3550	3350	3200	3050	2950	2750
<i>170x42</i>	5750	4600	4300	4000	3800	3600	3450	3350	3150
<i>200x42</i>	6400	5200	4900	4650	4450	4250	4050	3900	3650
<i>240x42</i>	7200	5900	5550	5300	5100	4900	4750	4650	4400
<i>300x42</i>	8300	6900	6500	6200	5950	5750	5600	5450	5200
<i>2/150x42</i>	5850	4900	4600	4350	4150	3950	3800	3650	3450
<i>2/170x42</i>	6350	5300	5050	4800	4600	4450	4300	4150	3900
<i>2/200x42</i>	7050	5950	5650	5400	5200	5000	4900	4750	4550
<i>2/240x42</i>	7850	6750	6400	6100	5900	5700	5550	5400	5200
<i>2/300x42</i>	9000	7800	7450	7150	6900	6700	6500	6350	6100
<i>2/360x42</i>	10000	8800	8400	8100	7850	7600	7400	7250	6950
<i>2/400x42</i>	10650	9450	9050	8700	8400	8200	7950	7800	7450
<i>150x58</i>	5550	4550	4200	3900	3700	3550	3400	3250	3050
<i>170x58</i>	6050	4950	4650	4400	4200	4000	3850	3700	3450
<i>200x58</i>	6700	5550	5250	5000	4800	4600	4500	4300	4050
<i>240x58</i>	7550	6300	5950	5700	5450	5300	5100	5000	4750
<i>300x58</i>	8650	7350	6950	6650	6400	6200	6000	5850	5600
<i>360x58</i>	9650	8300	7900	7550	7300	7050	6850	6700	6400
<i>400x58</i>	10300	8900	8450	8100	7850	7600	7400	7200	6900
<i>450x58</i>	11050	9650	9200	8800	8500	8250	8050	7850	7500
<i>240x75</i>	7750	6600	6250	6000	5750	5600	5400	5300	5050
<i>300x75</i>	8900	7650	7300	7000	6750	6550	6350	6200	5950
<i>400x75</i>	10550	9300	8850	8500	8250	8000	7800	7600	7300
<i>525x75</i>	12000	11050	10600	10250	9900	9650	9400	9200	8850
<i>300x82</i>	9000	7800	7400	7100	6850	6650	6500	6300	6050
<i>400x82</i>	10650	9400	9000	8650	8400	8150	7950	7750	7450

NOTES:

- Sizes in *Italics* are SmartLVL 14
- D = member depth, B = member breadth, NS = not suitable.
- The above table was based on a maximum ceiling mass of 20 kg/m²
- Minimum bearing length = 70 mm at end supports
- Not all sizes of SmartLVL in this table are stocked in each state. Please check with your supplier before ordering. WA only
- Top edge of Counter beams with D/B > 3 shall be laterally restrained as per details on page 5

Counter beam supporting hanging beam AS 4055 classification C1 - C3

ceiling mass - 20 kg/m²

Ceiling load width (mm)	600	1800	2400	3000	3600	4200	4800	5400	6600
Member size DxB (mm)	Maximum recommended Counter beam span (mm)								
<i>150x35</i>	4150	3150	2700	2450	2200	2050	1900	1800	1650
<i>170x35</i>	4700	3500	3050	2700	2500	2300	2150	2000	1850
<i>200x35</i>	5500	4050	3500	3150	2850	2650	2500	2350	2100
<i>240x35</i>	6600	4750	4150	3700	3400	3150	2950	2750	2500
<i>2/150x35</i>	5200	4650	4100	3650	3350	3100	2900	2750	2450
<i>2/170x35</i>	5900	5050	4550	4100	3750	3450	3250	3050	2750
<i>2/200x35</i>	6850	5700	5300	4750	4300	4000	3750	3550	3200
<i>2/240x35</i>	7650	6450	6100	5550	5100	4700	4400	4150	3750
150x42	5250	4000	3450	3100	2850	2600	2450	2300	2100
170x42	5750	4450	3850	3450	3150	2950	2750	2600	2350
200x42	6400	5150	4450	4000	3650	3400	3150	3000	2700
240x42	7200	5900	5250	4700	4300	4000	3750	3500	3200
300x42	8300	6900	6450	5750	5250	4900	4550	4300	3900
<i>2/150x42</i>	5850	4900	4600	4350	4150	3950	3700	3500	3150
<i>2/170x42</i>	6350	5300	5050	4800	4600	4400	4150	3900	3500
<i>2/200x42</i>	7050	5950	5650	5400	5200	5000	4800	4500	4100
<i>2/240x42</i>	7850	6750	6400	6100	5900	5700	5550	5300	4800
<i>2/300x42</i>	9000	7800	7450	7150	6900	6700	6500	6350	5850
<i>2/360x42</i>	10000	8800	8400	8100	7850	7600	7400	7250	6900
<i>2/400x42</i>	10650	9450	9050	8700	8400	8200	7950	7800	7450
150x58	5550	4500	3900	3500	3200	2950	2750	2600	2350
170x58	6050	4950	4350	3900	3550	3300	3100	2900	2650
200x58	6700	5550	5050	4500	4100	3800	3550	3350	3050
240x58	7550	6300	5900	5300	4850	4500	4200	3950	3600
300x58	8650	7350	6950	6500	5900	5500	5150	4850	4400
360x58	9650	8300	7900	7550	6950	6450	6050	5700	5150
400x58	10300	8900	8450	8100	7650	7100	6650	6250	5700
450x58	11050	9650	9200	8800	8500	7900	7400	6950	6300
240x75	7750	6600	6250	5750	5250	4900	4550	4300	3900
300x75	8900	7650	7300	7000	6450	5950	5600	5250	4750
400x75	10550	9300	8850	8500	8250	7700	7200	6800	6150
300x82	9000	7800	7400	7100	6600	6150	5750	5450	4900
400x82	10650	9400	9000	8650	8400	7950	7450	7000	6350

NOTES:

- Sizes in Italics are SmartLVL 14*
- D = member depth, B = member breadth, NS = not suitable.
- The above table was based on a maximum ceiling mass of 20 kg/m²
- Minimum bearing length = 70 mm at end supports
- Not all sizes of SmartLVL in this table are stocked in each state. Please check with your supplier before ordering. WA only
- Top edge of Counter beams with D/B > 3 shall be laterally restrained as per details on page 5

Strutting beam supporting underpurlins AS 4055 classification N1- N3

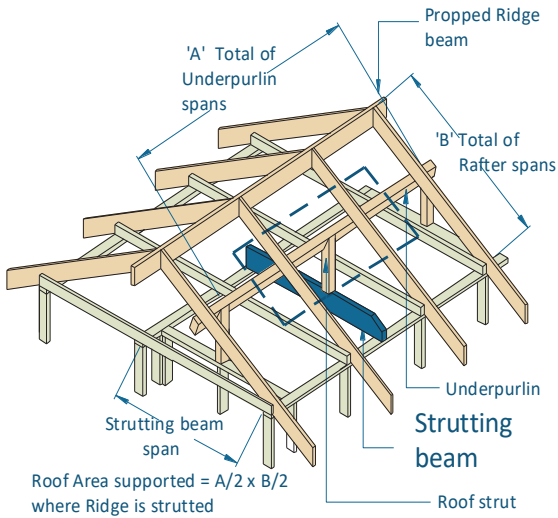

EXAMPLE:

wind speed = N3
 sheet roof = 20 kg/m²
 total of underpurlin span 'A' = 5000 mm
 total of rafter span 'B' = 4200 mm
 roof area supported = $(A/2) \times (B/2)$
 = $(5000/2) \times (4200/2)$
 = 5250000 mm² (Convert to m²)
 = 5250000/1000000 = 5.25 m²

strutting beam span = 4500 mm

Enter column at 6 m² roof area supported and read down to a span greater than or equal to 4500 mm

ADOPT:

SmartLVL 14 -240x35

Roof area supported (m ²)		2	4	6	8	10	12
Member size DxB (mm)	Roof mass (kg/m ²)	Maximum recommended Strutting beam span (mm)					
130x35	20	2900	2200	1450	NS	NS	NS
	60	2250	1600	1300	NS	NS	NS
140x35	20	3250	2550	1700	1200	NS	NS
	60	2500	1800	1450	NS	NS	NS
150x35	20	3600	2900	1900	1400	NS	NS
	60	2800	2000	1600	1000	NS	NS
170x35	20	4350	3600	2400	1800	1300	NS
	60	3350	2400	1950	1550	NS	NS
200x35	20	5350	4500	3200	2400	1900	1400
	60	4200	3050	2500	2100	1700	NS
240x35	20	6450	5800	4500	3350	2700	2250
	60	5450	3950	3250	2850	2350	1950
2/130x35	20	4100	3350	2800	2450	2000	1700
	60	3100	2250	1850	1600	1450	1300
2/140x35	20	4600	3700	3100	2700	2300	1900
	60	3450	2500	2050	1800	1600	1450
2/150x35	20	5050	4100	3400	3000	2600	2200
	60	3800	2800	2300	2000	1800	1600
2/170x35	20	5750	4850	4050	3600	3250	2750
	60	4550	3350	2750	2400	2150	1950
2/200x35	20	6750	5950	5100	4500	4100	3650
	60	5650	4200	3500	3050	2750	2500
2/240x35	20	8000	7000	6350	5800	5250	4850
	60	6750	5450	4550	3950	3550	3250
2/300x35	20	9400	8400	7700	7150	6750	6400
	60	8150	6900	6150	5450	4950	4550
130x42	20	3350	2750	2000	1500	NS	NS
	60	2550	1850	1500	1200	NS	NS
140x42	20	3700	3050	2300	1700	1150	NS
	60	2850	2050	1650	1450	NS	NS
150x42	20	4100	3350	2600	1950	1550	NS
	60	3100	2250	1850	1600	NS	NS
170x42	20	5000	3950	3300	2450	1950	1500
	60	3700	2700	2250	1950	1750	NS

Strutting beam supporting underpurlins AS 4055 classification N1 - N3 (Cont'd)

Roof area supported (m ²)		2	4	6	8	10	12
Member size DxB (mm)	Roof mass (kg/m ²)	Maximum recommended Strutting beam span (mm)					
200x42	20	5850	4950	4200	3300	2650	2200
	60	4650	3450	2850	2450	2200	2000
240x42	20	7050	6150	5350	4600	3650	3050
	60	5900	4450	3700	3250	2900	2650
300x42	20	8400	7400	6750	6300	5500	4600
	60	7150	6050	5100	4450	4000	3700
2/130x42	20	4650	3650	3100	2750	2450	2250
	60	3450	2550	2100	1850	1650	1500
2/140x42	20	5050	4050	3450	3050	2750	2500
	60	3800	2850	2350	2050	1850	1650
2/150x42	20	5450	4400	3750	3350	3050	2800
	60	4150	3100	2600	2250	2050	1850
2/170x42	20	6150	5150	4450	3950	3600	3350
	60	4900	3700	3100	2700	2450	2250
2/190x42	20	6700	5900	5150	4600	4200	3900
	60	5600	4350	3650	3200	2850	2650
2/200x42	20	6900	6150	5500	4950	4500	4200
	60	5950	4650	3900	3450	3100	2850
2/240x42	20	7850	7100	6550	6150	5750	5350
	60	6900	5900	5050	4450	4000	3700
2/300x42	20	9050	8400	7850	7400	7050	6750
	60	8200	7150	6500	6050	5500	5100
2/360x42	20	10150	9500	9000	8550	8200	7900
	60	9350	8300	7600	7100	6700	6350
2/400x42	20	10800	10200	9700	9300	8950	8600
	60	10050	9050	8350	7800	7350	7000
130x58	20	3900	3150	2650	2100	1650	1400
	60	2950	2150	1750	1500	1350	NS
150x58	20	4850	3850	3200	2700	2150	1800
	60	3600	2650	2150	1900	1700	1550
170x58	20	5550	4500	3850	3400	2700	2250
	60	4250	3150	2600	2250	2050	1850
200x58	20	6550	5550	4800	4250	3650	3050
	60	5250	3950	3300	2900	2600	2350
240x58	20	7500	6600	6050	5450	4950	4250
	60	6400	5100	4300	3750	3400	3100
300x58	20	8750	7900	7300	6800	6450	6150
	60	7650	6550	5850	5150	4650	4300
360x58	20	9850	9050	8450	7950	7550	7250
	60	8850	7700	6950	6450	6050	5550
400x58	20	10500	9750	9150	8650	8250	7950
	60	9550	8400	7650	7100	6650	6300
240x75	20	8100	7100	6450	5950	5450	5000
	60	6850	5600	4700	4100	3700	3400
300x75	20	9450	8500	7800	7300	6900	6550
	60	8250	7000	6250	5650	5100	4700
400x75	20	11450	10550	9850	9300	8850	8450
	60	10300	9000	8150	7550	7050	6700
525x75	20	12000	12000	12000	11550	11100	10650
	60	12000	11250	10300	9600	9100	8650
300x82	20	9600	8750	8100	7600	7150	6850
	60	8500	7300	6550	6050	5500	5050
400x82	20	11550	10750	10150	9600	9150	8800
	60	10550	9300	8450	7850	7400	7000

NOTES:

- Sizes in *Italics* are SmartLVL 14
- D = member depth, B = member breadth, NS = not suitable.
- Minimum bearing length = 70 mm at end supports
- Not all sizes of SmartLVL in this table are stocked in each state. Please check with your supplier before ordering. WA only
- Top edge of strutting beams with D/B > 3 shall be laterally restrained as per details on page 5

Strutting beam supporting underpurlins AS 4055 classification C1, C2 and C3

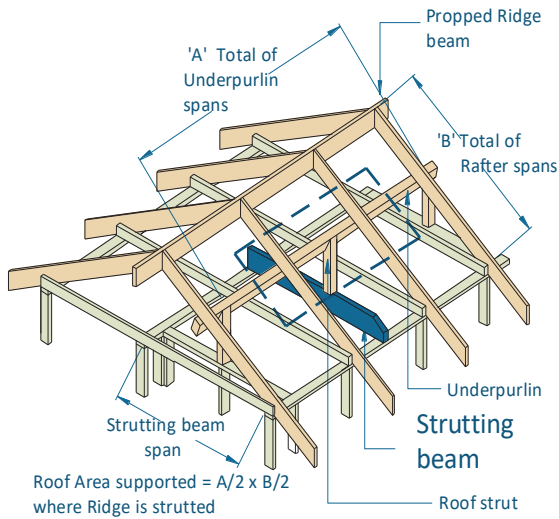

EXAMPLE:

wind speed = C3
 sheet roof = 20 kg/m²
 total of underpurlin span 'A' = 5000 mm
 total of rafter span 'B' = 4200 mm
 roof area supported = $(A/2) \times (B/2)$
 = $(5000/2) \times (4200/2)$
 = 5250000 mm² (Convert to m²)
 = 5250000/1000000 = 5.25 m²

strutting beam span = 4500 mm

Enter column at 6 m² roof area supported and read down to a span greater than or equal to 4500 mm

ADOPT:

SmartLVL 14 - 2/200x35

Roof area supported (m ²)		2	4	6	8	10	12
Member size DxB (mm)	Roof mass (kg/m ²)	Maximum recommended strutting beam span (mm)					
130x35	20	2900	1450	NS	NS	NS	NS
	60	2250	1500	NS	NS	NS	NS
140x35	20	3250	1650	NS	NS	NS	NS
	60	2500	1700	NS	NS	NS	NS
150x35	20	3600	1850	NS	NS	NS	NS
	60	2800	1950	1150	NS	NS	NS
170x35	20	4350	2350	1550	NS	NS	NS
	60	3350	2400	1600	NS	NS	NS
200x35	20	5350	3150	2100	1300	NS	NS
	60	4200	3050	2150	1500	NS	NS
240x35	20	6450	4400	2900	2200	1350	NS
	60	5450	3950	3000	2250	1550	1000
2/130x35	20	4100	3300	2200	1650	NS	NS
	60	3100	2250	1850	1600	1200	NS
2/140x35	20	4600	3700	2500	1900	1500	NS
	60	3450	2500	2050	1800	1550	NS
2/150x35	20	5050	4100	2850	2150	1700	NS
	60	3800	2800	2300	2000	1750	1150
2/170x35	20	5750	4850	3550	2650	2150	1750
	60	4550	3350	2750	2400	2150	1850
2/200x35	20	6750	5950	4800	3600	2850	2400
	60	5650	4200	3500	3050	2750	2500
2/240x35	20	8000	7000	6350	5000	4000	3300
	60	6750	5450	4550	3950	3550	3250
2/300x35	20	9400	8400	7700	7150	6000	5000
	60	8150	6900	6150	5450	4950	4550
130x42	20	3350	2000	1150	NS	NS	NS
	60	2550	1850	1400	NS	NS	NS
140x42	20	3700	2250	1500	NS	NS	NS
	60	2850	2050	1600	NS	NS	NS
150x42	20	4100	2550	1700	NS	NS	NS
	60	3100	2250	1800	NS	NS	NS
170x42	20	5000	3200	2150	1400	NS	NS
	60	3700	2700	2250	1650	NS	NS

Strutting beam supporting underpurlins AS 4055 classification C1 - C3 (Cont'd)

Roof area supported (m ²)		2	4	6	8	10	12
Member size DxB (mm)	Roof mass (kg/m ²)	Maximum strutting beam span (mm)					
200x42	20	5850	4350	2850	2150	1300	NS
	60	4650	3450	2850	2300	1450	NS
240x42	20	7050	6050	4000	3000	2400	1550
	60	5900	4450	3700	3200	2550	1750
300x42	20	8400	7400	6050	4500	3600	3000
	60	7150	6050	5100	4450	3800	3150 _s
2/130x42	20	4650	3650	3000	2250	1800	1150
	60	3450	2550	2100	1850	1650	1400
2/140x42	20	5050	4050	3450	2600	2050	1700
	60	3800	2850	2350	2050	1850	1650
2/150x42	20	5450	4400	3750	2950	2350	1950
	60	4150	3100	2600	2250	2050	1850
2/170x42	20	6150	5150	4450	3700	2950	2450
	60	4900	3700	3100	2700	2450	2250
2/200x42	20	6900	6150	5500	4950	3950	3300
	60	5950	4650	3900	3450	3100	2850
2/240x42	20	7850	7100	6550	6150	5500	4550
	60	6900	5900	5050	4450	4000	3700
2/300x42	20	9050	8400	7850	7400	7050	6750
	60	8200	7150	6500	6050	5500	5100
2/360x42	20	10150	9500	9000	8550	8200	7900
	60	9350	8300	7600	7100	6700	6350
2/400x42	20	10800	10200	9700	9300	8950	8600
	60	10050	9050	8350	7800	7350	7000
130x58	20	3900	2750	1800	1350	NS	NS
	60	2950	2150	1750	1450	NS	NS
150x58	20	4850	3550	2350	1750	1100	NS
	60	3600	2650	2150	1900	1250	NS
170x58	20	5550	4500	2950	2200	1750	1000
	60	4250	3150	2600	2250	1900	1150
200x58	20	6550	5550	4000	3000	2400	1950
	60	5250	3950	3300	2900	2550	2100
240x58	20	7500	6600	5550	4150	3300	2750
	60	6400	5100	4300	3750	3400	2950
300x58	20	8750	7900	7300	6250	5000	4150
	60	7650	6550	5850	5150	4650	4300
360x58	20	9850	9050	8450	7950	6750	5600
	60	8850	7700	6950	6450	6050	5550
400x58	20	10500	9750	9150	8650	8050	6650
	60	9550	8400	7650	7100	6650	6300
240x75	20	<i>8100</i>	<i>7100</i>	<i>5800</i>	<i>4300</i>	<i>3450</i>	<i>2850</i>
	60	<i>6850</i>	<i>5600</i>	<i>4700</i>	<i>4100</i>	<i>3550</i>	<i>2950</i>
300x75	20	<i>9450</i>	<i>8500</i>	<i>7800</i>	<i>6500</i>	<i>5150</i>	<i>4300</i>
	60	<i>8250</i>	<i>7000</i>	<i>6250</i>	<i>5650</i>	<i>5100</i>	<i>4400</i>
400x75	20	<i>11450</i>	<i>10550</i>	<i>9850</i>	<i>9300</i>	<i>8350</i>	<i>6950</i>
	60	<i>10300</i>	<i>9000</i>	<i>8150</i>	<i>7550</i>	<i>7050</i>	<i>6700</i>
525x75	20	<i>12000</i>	<i>12000</i>	<i>12000</i>	<i>11550</i>	<i>11100</i>	<i>10650</i>
	60	<i>12000</i>	<i>11250</i>	<i>10300</i>	<i>9600</i>	<i>9100</i>	<i>8650</i>
300x82	20	9600	8750	7800	5800	4600	3850
	60	8500	7300	6550	6050	5050	4200
400x82	20	11550	10750	10150	9600	7850	6500
	60	10550	9300	8450	7850	7400	7000

NOTES:

- Sizes in *Italics* are SmartLVL 14
- D = member depth, B = member breadth, NS = not suitable.
- Minimum bearing length = 70 mm at end supports.
- Restraint value for slenderness calculations is 1500 mm
- Not all sizes of SmartLVL in this table are stocked in each state. Please check with your supplier before ordering. WA only
- Top edge of strutting beams with D/B > 3 shall be laterally restrained as per details on page 5
- Value in subscript indicate extra bearing length required

Strutting/counter beam supporting underpurlins & hanging beam AS 4055 classification N1- N3

ceiling mass - 20 kg/m²

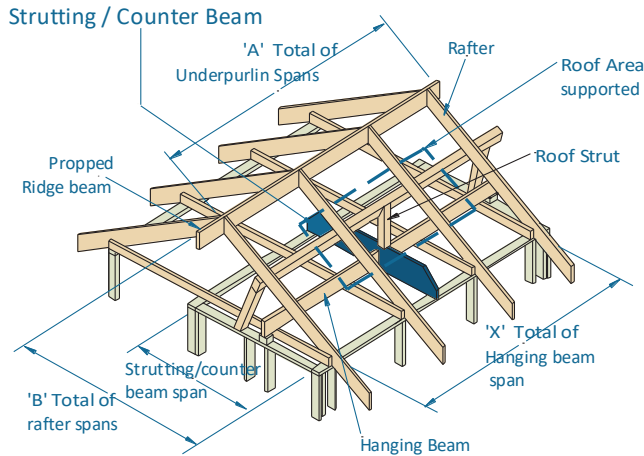

Roof Area supported = $A/2 \times B/2$ Counter/Strutting beam spacing = $X/2$

EXAMPLE:

wind speed = N3
sheet roof = 40 kg/m²
total of underpurlin span 'A' = 5000 mm
total of rafter span 'B' = 4200 mm
roof area supported = $(A/2) \times (B/2)$
= $(5000/2) \times (4200/2)$
= 5250000 mm² (Convert to m²)
= 5250000/1000000 = 5.25 m²

total of hanging beam span 'X' = 4500 mm
effective beam spacing = $X/2 = 4500/2 = 2250$ mm
strutting counter beam span = 4500 mm

Enter column at 3600 mm effective beam spacing, 6 m² roof area supported and read down to a span greater than or equal to 4500 mm

ADOPT:

SmartLVL 14 - 2/300x35

Effective beam spacing (mm)		1800						3600					
Roof area supported (m ²)		2	4	6	8	10	12	2	4	6	8	10	12
Member size DxB (mm)	Roof mass (kg/m ²)	Maximum recommended strutting/counter beam span (mm)											
150x35	40	2650	2150	1800	1350	1100	NS	2350	2000	1750	1350	1100	NS
	75	2250	1700	1450	1150	NS	NS	2100	1650	1400	1150	NS	NS
170x35	40	3100	2550	2150	1700	1400	1150	2750	2350	2050	1700	1350	1150
	75	2650	2050	1700	1450	1150	NS	2450	1950	1650	1400	1150	NS
200x35	40	3700	3100	2700	2300	1850	1550	3300	2850	2550	2200	1800	1550
	75	3300	2600	2200	1900	1550	1300	3000	2450	2100	1850	1500	1250
240x35	40	4300	3850	3450	3100	2550	2150	3900	3550	3200	2950	2500	2100
	75	3950	3300	2850	2500	2150	1800	3650	3100	2700	2400	2100	1750
2/150x35	40	3450	2900	2500	2250	2000	1850	3050	2650	2350	2150	1950	1800
	75	3050	2400	2000	1750	1600	1450	2750	2250	1950	1700	1550	1450
2/170x35	40	3900	3400	2950	2650	2400	2250	3500	3100	2750	2550	2350	2150
	75	3550	2850	2400	2100	1900	1750	3200	2650	2300	2050	1850	1700
2/200x35	40	4450	3950	3650	3300	3050	2800	4000	3700	3400	3100	2900	2700
	75	4100	3500	3000	2650	2400	2200	3800	3300	2900	2600	2350	2200
2/240x35	40	5100	4650	4300	4000	3800	3600	4650	4300	4050	3850	3650	3450
	75	4750	4150	3800	3450	3150	2900	4400	3950	3650	3300	3050	2850
2/300x35	40	6100	5600	5200	4900	4650	4450	5500	5150	4900	4650	4450	4300
	75	5700	5100	4650	4300	4050	3850	5250	4800	4450	4150	3950	3750
150x42	40	2950	2400	2050	1800	1650	1400	2600	2250	1950	1750	1600	1400
	75	2550	1950	1650	1450	1300	1150	2350	1850	1600	1400	1250	1150
170x42	40	3400	2800	2450	2200	2000	1750	3000	2600	2300	2100	1900	1700
	75	2950	2350	1950	1700	1550	1400	2700	2200	1900	1700	1500	1400
200x42	40	3950	3450	3050	2750	2500	2300	3600	3150	2850	2600	2400	2250
	75	3600	2900	2450	2200	1950	1800	3300	2750	2400	2100	1950	1800

Strutting/counter beam supporting underpurlins & hanging beam AS 4055 classification N1- N3 (Cont'd)

ceiling mass - 20 kg/m²

Effective beam spacing (mm)		1800						3600					
Roof area supported (m ²)		2	4	6	8	10	12	2	4	6	8	10	12
Member size DxB (mm)	Roof mass (kg/m ²)	Maximum recommended strutting/counter beam span (mm)											
240x42	40	4550	4100	3800	3500	3200	3000	4150	3850	3600	3300	3050	2850
	75	4250	3650	3200	2850	2550	2350	3900	3450	3050	2750	2500	2300
300x42	40	5450	4950	4600	4300	4100	3900	4900	4600	4350	4100	3950	3800
	75	5100	4500	4100	3800	3500	3250	4700	4250	3900	3650	3400	3150
2/150x42	40	3700	3200	2800	2500	2300	2100	3350	2950	2650	2400	2200	2050
	75	3350	2650	2250	2000	1800	1650	3050	2550	2200	1950	1750	1650
2/170x42	40	4100	3700	3300	2950	2750	2550	3750	3400	3100	2800	2600	2450
	75	3800	3150	2700	2400	2150	2000	3500	2950	2600	2350	2100	1950
2/190x42	40	4500	4050	3750	3450	3150	2950	4100	3800	3550	3250	3050	2850
	75	4150	3650	3150	2800	2550	2350	3850	3400	3000	2700	2500	2300
2/200x42	40	4650	4250	3900	3650	3400	3150	4250	3950	3700	3450	3250	3050
	75	4350	3800	3400	3000	2750	2550	4050	3600	3200	2900	2650	2450
2/240x42	40	5350	4900	4600	4300	4100	3900	4900	4550	4300	4100	3950	3800
	75	5050	4450	4050	3800	3550	3300	4650	4250	3900	3650	3400	3200
2/300x42	40	6300	5850	5500	5250	5000	4800	5750	5450	5200	4950	4750	4600
	75	6000	5400	4950	4650	4400	4150	5500	5100	4750	4500	4250	4100
2/360x42	40	7150	6750	6400	6100	5850	5600	6550	6250	6000	5750	5550	5400
	75	6850	6250	5800	5450	5200	4950	6300	5900	5550	5250	5000	4800
2/400x42	40	7700	7300	6950	6650	6400	6150	7050	6750	6500	6250	6050	5900
	75	7400	6800	6350	6000	5700	5450	6850	6400	6050	5750	5500	5300
150x58	40	3300	2750	2400	2100	1900	1750	2950	2550	2250	2050	1850	1750
	75	2900	2250	1900	1650	1500	1400	2650	2150	1850	1650	1500	1350
170x58	40	3750	3200	2800	2500	2300	2150	3350	2950	2650	2400	2200	2050
	75	3400	2700	2300	2000	1800	1650	3050	2550	2200	1950	1800	1650
200x58	40	4300	3850	3500	3150	2900	2700	3900	3600	3250	3000	2750	2600
	75	3950	3350	2850	2550	2300	2100	3650	3150	2750	2450	2250	2100
240x58	40	4950	4500	4150	3900	3650	3450	4500	4150	3900	3700	3500	3300
	75	4600	4050	3650	3300	3000	2750	4250	3850	3500	3150	2900	2700
300x58	40	5850	5400	5000	4750	4500	4300	5300	5000	4700	4500	4300	4150
	75	5500	4900	4500	4150	3900	3700	5050	4650	4300	4050	3800	3650
360x58	40	6700	6200	5850	5550	5300	5100	6050	5750	5500	5250	5050	4850
	75	6350	5700	5250	4900	4650	4400	5850	5400	5050	4750	4500	4300
400x58	40	7200	6750	6400	6050	5800	5550	6550	6200	5950	5700	5500	5350
	75	6850	6250	5800	5400	5100	4900	6300	5850	5500	5200	4950	4750
450x58	40	7800	7400	7000	6700	6400	6200	7100	6800	6550	6300	6100	5900
	75	7500	6850	6400	6000	5700	5450	6900	6450	6050	5750	5500	5300
240x75	40	5200	4750	4400	4100	3900	3700	4700	4400	4100	3900	3750	3550
	75	4850	4250	3850	3550	3250	3000	4500	4050	3700	3400	3150	2900
300x75	40	6150	5700	5300	5000	4750	4550	5550	5250	4950	4750	4550	4400
	75	5800	5200	4750	4400	4150	3950	5350	4900	4550	4250	4050	3850
400x75	40	7600	7150	6750	6400	6150	5900	6850	6550	6300	6050	5800	5650
	75	7250	6600	6100	5750	5400	5150	6650	6200	5800	5500	5250	5000
525x75	40	9200	8750	8400	8050	7750	7450	8350	8000	7750	7500	7300	7100
	75	8900	8250	7700	7300	6950	6650	8100	7650	7250	6950	6650	6400
300x82	40	6400	5900	5550	5250	5000	4720	5750	5450	5200	4950	470	4600
	75	6050	5400	4950	4600	4350	4150	5550	5100	4750	4450	4250	4050
400x82	40	7850	7400	7000	6700	6400	6150	7100	6800	6500	6300	6050	5900
	75	7500	6850	6400	6000	5700	5400	6900	6400	6050	5750	5500	5250

NOTES:

- Sizes in *Italics* are SmartLVL 14
- D = member depth, B = member breadth, NS = not suitable.
- Minimum bearing length = 70 mm at end supports
- The above table was based on a maximum ceiling mass of 20 kg/m²
- Top edge of strutting/counter beams with D/B > 3 shall be laterally restrained as per details on page 5
- Not all sizes of SmartLVL in this table are stocked in each state. Please check with your supplier before ordering. WA only

Strutting/counter beam supporting underpurlins & hanging beam AS 4055 classification C1 - C3

ceiling mass - 20 kg/m²

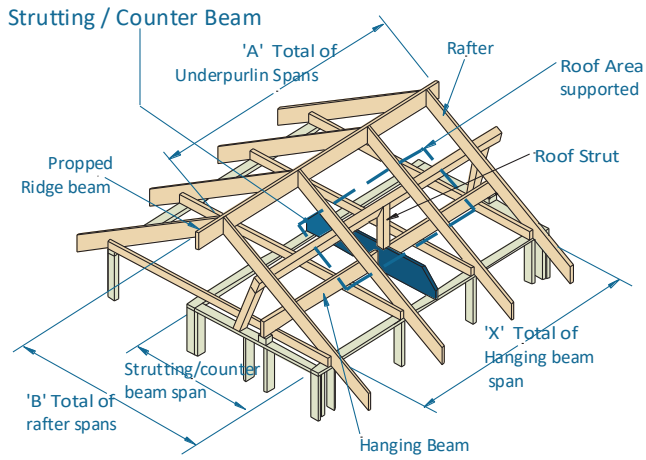

EXAMPLE:

wind speed = C3
 sheet roof = 40 kg/m²
 total of underpurlin span 'A' = 5000 mm
 total of rafter span 'B' = 4200 mm
 roof area supported = (A/2) x (B/2)
 = (5000/2) x (4200/2)
 = 5250000 mm² (Convert to m²)
 = 5250000/1000000 = 5.25 m²

total of hanging beam span 'X' = 4500 mm
 effective beam spacing = 'X' / 2 = 4500 / 2 = 2250 mm
 strutting counter beam span = 4500 mm

Enter column at 3600 mm effective beam spacing, 6m² roof area supported and read down to a span greater than or equal to 4500 mm

ADOPT:

SmartLVL 14 - 2/300x35

Roof Area supported = A/2xB/2 Counter/Strutting beam spacing = X/2

Effective beam spacing (mm)		1800						3600					
Roof area supported (m ²)		2	4	6	8	10	12	2	4	6	8	10	12
Member size DxB (mm)	Roof mass (kg/m ²)	Maximum recommended Strutting/counter beam span (mm)											
150x35	40	2650	1300	NS	NS	NS	NS	2350	1350	NS	NS	NS	NS
	75	2250	1350	NS	NS	NS	NS	2100	1300	NS	NS	NS	NS
170x35	40	3100	1650	1100	NS	NS	NS	2750	1700	1100	NS	NS	NS
	75	2650	1650	1100	NS	NS	NS	2450	1650	1100	NS	NS	NS
200x35	40	3700	2250	1500	1100	NS	NS	3300	2300	1500	1100	NS	NS
	75	3300	2200	1500	1150	NS	NS	3000	2150	1500	1100	NS	NS
240x35	40	4300	3200	2050	1550	1200	NS	3900	3200	2100	1550	1250	NS
	75	3950	3050	2100	1550	1250	NS	3650	2900	2050	1550	1250	NS
2/150x35	40	3450	2900	2000	1500	1200	1000	3050	2650	2050	1500	1200	1000
	75	3050	2400	2000	1550	1200	1000	2750	2250	1950	1500	1200	1000
2/170x35	40	3900	3400	2550	1900	1500	1250	3500	3100	2600	1900	1500	1250
	75	3550	2850	2400	1900	1550	1300	3200	2650	2300	1900	1500	1250
2/200x35	40	4450	3950	3450	2550	2050	1700	4000	3700	3400	2600	2050	1700
	75	4100	3500	3000	2550	2050	1700	3800	3300	2900	2500	2050	1700
2/240x35	40	5100	4650	4300	3600	2850	2350	4650	4300	4050	3650	2850	2350
	75	4750	4150	3800	3450	2850	2400	4400	3950	3650	3300	2800	2350
2/300x35	40	6100	5600	5200	4900	4300	3550	5500	5150	4900	4650	4400	3600
	75	5700	5100	4650	4300	4050	3550	5250	4800	4450	4150	3950	3500
150x42	40	2950	1800	1200	NS	NS	NS	2600	1850	1200	NS	NS	NS
	75	2550	1950	1250	NS	NS	NS	2350	1850	1300	NS	NS	NS
170x42	40	3400	2300	1500	1100	NS	NS	3000	2350	1500	1100	NS	NS
	75	2950	2350	1600	1200	NS	NS	2700	2200	1600	1200	NS	NS
200x42	40	3950	3100	2000	1500	1200	NS	3600	3150	2050	1500	1200	NS
	75	3600	2900	2150	1600	1250	NS	3300	2750	2200	1600	1300	NS

Strutting/counter beam supporting underpurlins & hanging beam AS 4055 classification C1 - C3 (Cont'd)

ceiling mass - 20 kg/m²

Effective beam spacing (mm)		1800						3600					
Roof area supported (m ²)		2	4	6	8	10	12	2	4	6	8	10	12
Member size DxB (mm)	Roof mass (kg/m ²)	Maximum recommended Strutting /counter span (mm)											
240x42	40	4550	4100	2800	2100	1650	1400	4150	3850	2900	2100	1650	1400
	75	4250	3650	3050	2250	1800	1500	3900	3450	3050	2250	1800	1500
300x42	40	5450	4950	4300	3150	2500	2100	4900	4600	4350	3200	2550	2100
	75	5100	4500	4100	3400	2700	2250	4700	4250	3900	3450	2700	2250
2/150x42	40	3700	3200	2750	2050	1600	1350	3350	2950	2650	2050	1650	1350
	75	3350	2650	2250	2000	1750	1450	3050	2550	2200	1950	1750	1450
2/170x42	40	4100	3700	3300	2600	2050	1700	3750	3400	3100	2600	2050	1700
	75	3800	3150	2700	2400	2150	1800	3500	2950	2600	2350	2100	1850
2/200x42	40	4650	4250	3900	3500	2750	2300	4250	3950	3700	3450	2800	2300
	75	4350	3800	3400	3000	2750	2450	4050	3600	3200	2900	2650	2450
2/240x42	40	5350	4900	4600	4300	3850	3200	4900	4550	4300	4100	3900	3250
	75	5050	4450	4050	3800	3550	3300	4650	4250	3900	3650	3400	3200
2/300x42	40	6300	5850	5500	5250	5000	4800	5750	5450	5200	4950	4750	4600
	75	6000	5400	4950	4650	4400	4150	5500	5100	4750	4500	4250	4100
2/360x42	40	7150	6750	6400	6100	5850	5600	6550	6250	6000	5750	5550	5400
	75	6850	6250	5800	5450	5200	4950	6300	5900	5550	5250	5000	4800
2/400x42	40	7700	7300	6950	6650	6400	6150	7050	6750	6500	6250	6050	5900
	75	7400	6800	6350	6000	5700	5450	6850	6400	6050	5750	5500	5300
150x58	40	3300	2500	1650	1200	NS	NS	2950	2550	1650	1250	NS	NS
	75	2900	2250	1750	1300	1050	NS	2650	2150	1800	1300	1050	NS
170x58	40	3750	3200	2100	1550	1200	1000	3350	2950	2100	1550	1250	1000
	75	3400	2700	2250	1650	1300	1100	3050	2550	2200	1650	1300	1100
200x58	40	4300	3850	2800	2100	1650	1350	3900	3600	2850	2100	1650	1400
	75	3950	3350	2850	2250	1750	1450	3650	3150	2750	2250	1800	1450
240x58	40	4950	4500	3950	2900	2300	1900	4500	4150	3900	2950	2350	1950
	75	4600	4050	3650	3100	2500	2050	4250	3850	3500	3150	2500	2050
300x58	40	5850	5400	5000	4400	3500	2900	5300	5000	4700	4500	3550	2900
	75	5500	4900	4500	4150	3750	3100	5050	4650	4300	4050	3800	3150
360x58	40	6700	6200	5850	5550	4750	3900	6050	5750	5500	5250	4850	3950
	75	6350	5700	5250	4900	4650	4200	5850	5400	5050	4750	4500	4250
400x58	40	7200	6750	6400	6050	5700	4700	6550	6200	5950	5700	5500	4750
	75	6850	6250	5800	5400	5100	4900	6300	5850	5500	5200	4950	4750
450x58	40	7800	7400	7000	6700	6400	5700	7100	6800	6550	6300	6100	5850
	75	7500	6850	6400	6000	5700	5450	6900	6450	6050	5750	5500	5300
240x75	40	5200	4750	4200	3100	2450	2000	4700	4400	4100	3150	2450	2050
	75	4850	4250	3850	3050	2450	2050	4500	4050	3700	3000	2450	2050
300x75	40	6150	5700	5300	4650	3700	3050	5550	5250	4950	4750	3750	3100
	75	5800	5200	4750	4400	3650	3050	5350	4900	4550	4250	3600	3000
400x75	40	7600	7150	6750	6400	6000	4950	6850	6550	6300	6050	5800	5050
	75	7250	6600	6100	5750	5400	4850	6650	6200	5800	5500	5250	4700
545x75	40	9200	8750	8400	8050	7750	7450	8350	8000	7750	7500	7300	7100
	75	8900	8250	7700	7300	6950	6650	8100	7650	7250	6950	6650	6400
300x82	40	6400	5900	5550	5250	4950	4050	5750	5450	5200	4950	4750	4150
	75	6050	5400	4950	4600	4350	4150	5550	5100	4750	4450	4250	4050
400x82	40	7850	7400	7000	6700	6400	6150	7100	6800	6500	6300	6050	5900
	75	7500	6850	6400	6000	5700	5400	6900	6400	6050	5750	5500	5250

NOTES:

1. D = member depth, B = member breadth, NS = not suitable.
2. Minimum bearing length = 70 mm at end supports.
3. The above table was based on a maximum ceiling mass of 20 kg/m²
4. Top edge of strutting/counter beams with D/B > 3 shall be laterally restrained as per details on page 5
5. Not all sizes of SmartLVL in this table are stocked in each state. Please check with your supplier before ordering. WA only

Strutting/hanging beam AS 4055 classification N1 - N3

ceiling mass - 20 kg/m²

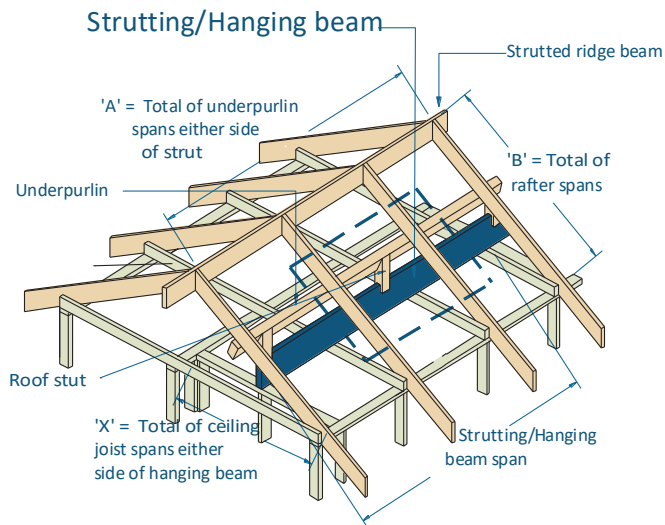

EXAMPLE:

wind speed = N3
 sheet roof = 40 kg/m²
 A = 5000 mm, B = 4200 mm
 roof area supported = (A/2) x (B/2)
 = (5000/2) x (4200/2)
 = 5250000 mm² (Convert to m²)
 = 5250000/1000000 = 5.25 m²

strutting/hanging beam span = 4200 mm
 ceiling joist span ('X') = 4400 mm
 ceiling load width = ['X' / 2] = 4400/2 = 2200 mm

Enter column at 3600 mm ceiling load width, 6 m² roof area supported and read down to a span greater than or equal to 4200 mm

ADOPT:

SmartLVL 14 - 300x35

Roof Area Supported = A/2 x B/2 Ceiling Load width = X/2

Ceiling load width (mm)		1800						3600					
Roof area supported (m ²)		2	4	6	8	10	12	2	4	6	8	10	12
Member size DxB (mm)	Roof mass (kg/m ²)	Maximum recommended Strutting/hanging beam span (mm)											
150x35	40	2500	2100	1800	1400	NS	NS	2100	1800	1600	1300	NS	NS
	75	2200	1700	1400	NS	NS	NS	1900	1600	1300	NS	NS	NS
170x35	40	2900	2400	2100	1700	1200	NS	2500	2200	1900	1600	1100	NS
	75	2600	2000	1700	1300	NS	NS	2200	1900	1600	1300	NS	NS
200x35	40	3600	3000	2600	2300	1800	1300	3000	2700	2400	2200	1800	1200
	75	3200	2500	2100	1900	1300	NS	2700	2300	2000	1800	1200	NS
240x35	40	4200	3700	3400	3100	2500	2100	3600	3300	3000	2800	2400	2100
	75	3900	3200	2800	2500	2100	1500	3400	2900	2600	2300	2100	1500
2/150x35	40	3300	2800	2400	2200	2000	1800	2800	2500	2200	2000	1900	1700
	75	2900	2300	2000	1700	1600	1400	2600	2100	1900	1700	1500	1400
2/170x35	40	3800	3300	2900	2600	2400	2200	3200	2900	2600	2400	2200	2100
	75	3400	2800	2300	2100	1900	1700	3000	2500	2200	2000	1800	1700
2/200x35	40	4300	3900	3600	3200	3000	2800	3800	3500	3200	3000	2800	2600
	75	4000	3400	3000	2600	2400	2200	3600	3100	2800	2500	2300	2100
2/240x35	40	5000	4600	4200	4000	3700	3600	4400	4100	3900	3700	3500	3300
	75	4700	4100	3700	3400	3100	2900	4200	3800	3500	3200	2900	2800
2/300x35	40	6000	5500	5100	4800	4600	4400	5200	4900	4700	4500	4300	4200
	75	5600	5000	4600	4300	4000	3800	5000	4600	4300	4100	3900	3700
150x42	40	2800	2350	2000	1800	1650	1000	2400	2100	1850	1700	1550	1000
	75	2450	1900	1600	1400	1000	NS	2150	1800	1550	1350	NS	NS
170x42	40	3250	2750	2400	2150	1950	1750	2750	2450	2200	2000	1850	1700
	75	2900	2300	1950	1700	1550	NS	2550	2100	1850	1650	1500	NS
200x42	40	3850	3400	3000	2700	2450	2300	3300	2950	2700	2500	2300	2150
	75	3550	2850	2450	2150	1950	1800	3050	2600	2300	2050	1900	1750

Strutting/hanging beam AS 4055 classification N1, N2 and N3 (Cont'd)

ceiling mass - 20 kg/m²

Ceiling load width (mm)		1800						3600					
Roof area supported (m ²)		2	4	6	8	10	12	2	4	6	8	10	12
Member size DxB (mm)	Roof mass (kg/m ²)	Maximum strutting/hanging beam span (mm)											
		240x42	40	4450	4050	3700	3450	3150	2950	3900	3650	3400	3150
	75	4150	3600	3150	2800	2550	2350	3750	3300	2900	2650	2450	2250
300x42	40	5350	4900	4550	4250	4050	3850	4650	4400	4150	4000	3800	3700
	75	5000	4450	4050	3750	3500	3250	4450	4100	3800	3550	3300	3100
2/150x42	40	3650	3100	2750	2450	2250	2100	3100	2750	2500	2300	2150	2000
	75	3250	2600	2250	2000	1800	1650	2850	2400	2100	1900	1750	1600
2/170x42	40	4000	3600	3250	2950	2700	2500	3500	3200	2900	2700	2500	2350
	75	3700	3100	2650	2350	2150	2000	3300	2850	2500	2250	2050	1900
2/200x42	40	4550	4150	3850	3600	3350	3150	4000	3750	3550	3300	3100	2950
	75	4250	3750	3350	3000	2700	2500	3850	3450	3100	2800	2600	2400
2/240x42	40	5250	4850	4500	4250	4050	3900	4650	4400	4150	4000	3800	3700
	75	4950	4400	4050	3750	3500	3250	4450	4100	3800	3600	3350	3100
2/300x42	40	6200	5800	5450	5200	4950	4750	5500	5200	5000	4800	4650	4500
	75	5900	5350	4900	4600	4350	4150	5300	4900	4600	4400	4200	4000
2/360x42	40	7100	6700	6350	6050	5800	5600	6250	6000	5800	5600	5400	5250
	75	6800	6200	5750	5450	5150	4900	6100	5700	5400	5150	4900	4700
2/400x42	40	7650	7250	6900	6600	6350	6100	6800	6500	6300	6100	5900	5750
	75	7350	6750	6300	5950	5650	5400	6600	6200	5900	5600	5400	5200
150x58	40	3200	2700	2350	2100	1900	1750	2700	2400	2150	1950	1800	1700
	75	2800	2250	1900	1650	1500	1350	2450	2050	1800	1600	1450	1350
170x58	40	3650	3150	2750	2500	2250	2100	3100	2750	2500	2300	2150	2000
	75	3300	2650	2250	2000	1800	1650	2850	2450	2150	1900	1750	1600
200x58	40	4200	3750	3400	3100	2850	2650	3650	3350	3100	2850	2650	2500
	75	3900	3300	2850	2500	2300	2100	3450	3000	2650	2400	2200	2050
240x58	40	4850	4400	4100	3850	3650	3400	4250	4000	3750	3600	3350	3200
	75	4500	4000	3600	3250	2950	2750	4050	3700	3350	3050	2800	2650
300x58	40	5750	5300	4950	4700	4450	4250	5050	4750	4550	4350	4200	4050
	75	5400	4850	4450	4150	3900	3700	4850	4450	4150	3950	3750	3550
360x58	40	6600	6150	5800	5500	5250	5050	5800	5500	5300	5100	4900	4750
	75	6250	5650	5200	4900	4600	4400	5600	5200	4900	4650	4400	4250
400x58	40	7100	6700	6300	6000	5750	5550	6250	6000	5750	5550	5350	5200
	75	6800	6200	5750	5400	5100	4850	6050	5650	5350	5100	4850	4650
450x58	40	7750	7300	6950	6650	6350	6150	6850	6550	6300	6100	5900	5750
	75	7450	6800	6350	6000	5650	5400	6650	6250	5900	5650	5400	5200
240x75	40	<i>5100</i>	<i>4600</i>	<i>4300</i>	<i>4000</i>	<i>3800</i>	<i>3700</i>	<i>4400</i>	<i>4200</i>	<i>4000</i>	<i>3800</i>	<i>3600</i>	<i>3400</i>
	75	<i>4800</i>	<i>4200</i>	<i>3800</i>	<i>3500</i>	<i>3200</i>	<i>3000</i>	<i>4200</i>	<i>3900</i>	<i>3600</i>	<i>3300</i>	<i>3000</i>	<i>2800</i>
300x75	40	<i>6100</i>	<i>5600</i>	<i>5200</i>	<i>4900</i>	<i>4700</i>	<i>4500</i>	<i>5300</i>	<i>5000</i>	<i>4800</i>	<i>4600</i>	<i>4400</i>	<i>4300</i>
	75	<i>5700</i>	<i>5100</i>	<i>4700</i>	<i>4400</i>	<i>4100</i>	<i>3900</i>	<i>5100</i>	<i>4700</i>	<i>4400</i>	<i>4100</i>	<i>3900</i>	<i>3800</i>
400x75	40	<i>7500</i>	<i>7100</i>	<i>6700</i>	<i>6400</i>	<i>6100</i>	<i>5900</i>	<i>6600</i>	<i>6300</i>	<i>6100</i>	<i>5800</i>	<i>5700</i>	<i>5500</i>
	75	<i>7200</i>	<i>6600</i>	<i>6100</i>	<i>5700</i>	<i>5400</i>	<i>5100</i>	<i>6400</i>	<i>6000</i>	<i>5600</i>	<i>5400</i>	<i>5100</i>	<i>4900</i>
525x75	40	<i>9200</i>	<i>8700</i>	<i>8400</i>	<i>8000</i>	<i>7700</i>	<i>7400</i>	<i>8100</i>	<i>7800</i>	<i>7500</i>	<i>7300</i>	<i>7100</i>	<i>6900</i>
	75	<i>8900</i>	<i>8200</i>	<i>7700</i>	<i>7300</i>	<i>6900</i>	<i>6600</i>	<i>7900</i>	<i>7400</i>	<i>7100</i>	<i>6800</i>	<i>6500</i>	<i>6300</i>
300x82	40	6300	5850	5450	5200	4950	4750	5500	5250	5000	4800	4600	4450
	75	5950	5350	4900	4600	4300	4100	5300	4900	4600	4350	4140	3950
400x82	40	7800	7350	6950	6650	6350	6100	6850	6550	6300	6100	5900	5750
	75	7450	6800	6350	5950	5650	5400	6650	6200	5900	5600	5350	5150

NOTES:

- Sizes in *Italics* are SmartLVL 14
- D = member depth, B = member breadth, NS = not suitable.
- The above table was based on a maximum ceiling mass of 20 kg/m²
- Minimum bearing length = 70 mm at end supports.
- Top edge of strutting/hanging beams with D/B > 3 shall be laterally restrained as per detail on page 5
- Not all sizes of SmartLVL in this table are stocked in each state. Please check with your supplier before ordering. WA only

Strutting/hanging beam AS 4055 classification C1 - C3

ceiling mass - 20 kg/m²

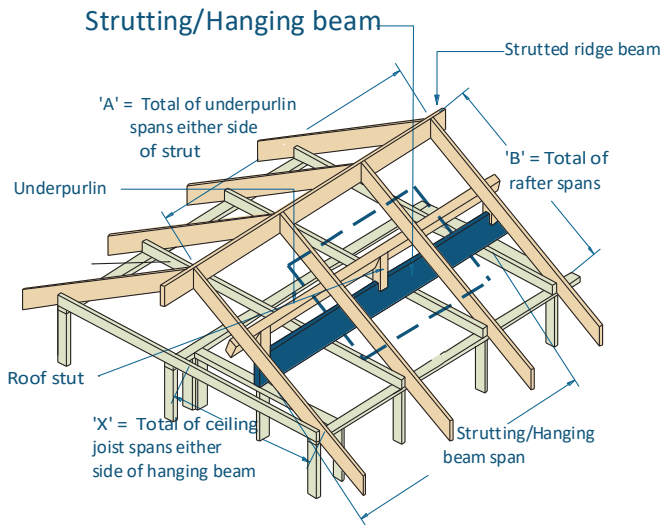

EXAMPLE:

wind speed = C3

sheet roof = 40 kg/m²

A = 5000 mm, B = 4200 mm

roof area supported = (A/2) x (B/2)

$$= (5000/2) \times (4200/2)$$

$$= 5250000 \text{ mm}^2 \text{ (Convert to m}^2\text{)}$$

$$= 5250000/1000000 = 5.25 \text{ m}^2$$

strutting hanging beam span = 4200 mm

ceiling joist span ('X') = 4400 mm

ceiling load width = ('X' / 2) = 4400/2 = 2200 mm

Enter column at 3600 mm ceiling load width, 6m² roof area supported and read down to a span greater than or equal to 4200 mm

ADOPT:

SmartLVL 14 - 2/300x35

Roof Area Supported = A/2 x B/2 Ceiling Load width = X/2

Ceiling load width (mm)		1800						3600					
Roof area supported (m ²)		2	4	6	8	10	12	2	4	6	8	10	12
Member size DxB (mm)	Roof mass (kg/m ²)	Maximum recommended Strutting/hanging beam span (mm)											
150x35	40	2500	1300	NS	NS	NS	NS	2100	1300	NS	NS	NS	NS
	75	2200	1300	NS	NS	NS	NS	1900	1200	NS	NS	NS	NS
170x35	40	2900	1700	NS	NS	NS	NS	2500	1700	NS	NS	NS	NS
	75	2600	1600	NS	NS	NS	NS	2200	1600	NS	NS	NS	NS
200x35	40	3600	2300	1100	NS	NS	NS	3000	2300	1100	NS	NS	NS
	75	3200	2200	1200	NS	NS	NS	2700	2100	1100	NS	NS	NS
240x35	40	4200	3200	2100	1000	NS	NS	3600	3100	2100	1000	NS	NS
	75	3900	3000	2100	1100	NS	NS	3400	2900	2000	1100	NS	NS
2/150x35	40	3300	2800	2000	1300	NS	NS	2800	2500	2100	1300	NS	NS
	75	2900	2300	2000	1400	NS	NS	2600	2100	1900	1300	NS	NS
2/170x35	40	3800	3300	2600	1900	1000	NS	3200	2900	2600	1900	1000	NS
	75	3400	2800	2300	1900	1100	NS	3000	2500	2200	1900	1000	NS
2/200x35	40	4300	3900	3500	2500	2000	1100	3800	3500	3200	2600	2000	1100
	75	4000	3400	3000	2600	2000	1200	3600	3100	2800	2500	2000	1200
2/240x35	40	5000	4600	4200	3600	2800	2300	4400	4100	3900	3700	2900	2400
	75	4700	4100	3700	3400	2800	2400	4200	3800	3500	3200	2800	2300
2/300x35	40	6000	5500	5100	4800	4300	3600	5200	4900	4700	4500	4300	3600
	75	5600	5000	4600	4300	4000	3600	5000	4600	4300	4100	3900	3500
150x42	40	2800	2200	1700	NS	NS	NS	2000	2050	1650	NS	NS	NS
	75	2450	1900	1300	NS	NS	NS	2050	1800	1200	NS	NS	NS
170x42	40	3200	2650	2150	1200	NS	NS	2250	2300	2050	1150	NS	NS
	75	2900	2300	1900	NS	NS	NS	2250	2100	1850	NS	NS	NS
200x42	40	3650	3400	2800	2150	1150	NS	2600	2650	2700	2100	1150	NS
	75	3550	2850	2450	1700	NS	NS	2600	2600	2300	1600	NS	NS

Strutting/hanging beam AS 4055 classification C1 - C3 (Cont'd)

ceiling mass - 20 kg/m²

Ceiling load width (mm)		1800						3600					
Roof area supported (m ²)		2	4	6	8	10	12	2	4	6	8	10	12
Member size DxB (mm)	Roof mass (kg/m ²)	Maximum recommended strutting/hanging beam span (mm)											
240x42	40	4300	4050	3650	2950	2400	1400	3050	3100	3150	2850	2350	1350
	75	4150	3600	3150	2650	1750	1050	3050	3150	2900	2600	1700	1050
300x42	40	5250	4900	4550	4250	3550	3000 ₁₀	3700	3750	3800	3850	3450	2900 ₁₀
	75	5000	4450	4050	3750	3200 ₅	2550 ₁₅	3750	3800	3800	3550	3100 ₁₀	2450 ₂₀
2/150x42	40	3650	3100	2550	2200	1950	1800	3000	2750	2500	2200	1950	1800
	75	3250	2600	2250	2000	1800	1300	2850	2400	2100	1900	1750	1250
2/170x42	40	4000	3600	3100	2650	2400	2200	3350	3200	2900	2650	2400	2200
	75	3700	3100	2650	2350	2150	2000	3300	2850	2500	2250	2050	1900
2/200x42	40	4550	4150	3850	3400	3050	2800	3850	3750	3550	3300	3050	2800
	75	4250	3750	3350	3000	2700	2500	3850	3450	3100	2800	2600	2400
2/240x42	40	5250	4850	4500	4250	4000	3650	4550	4400	4150	4000	3800	3650
	75	4950	4400	4050	3750	3500	3250	4450	4100	3800	3600	3350	3100
2/300x42	40	6200	5800	5450	5200	4950	4750	5500	5200	5000	4800	4650	4500
	75	5900	5350	4900	4600	4350	4150	5300	4900	4600	4400	4200	4000
2/360x42	40	7100	6700	6350	6050	5800	5600	6250	6000	5800	5600	5400	5250
	75	6800	6200	5750	5450	5150	4900	6100	5700	5400	5150	4900	4700
2/400x42	40	7650	7250	6900	6600	6350	6100	6800	6500	6300	6100	5900	5750
	75	7350	6750	6300	5950	5650	5400	6600	6200	5900	5600	5400	5200
150x58	40	3200	2600	2100	1750	NS	NS	2350	2400	2100	1750	NS	NS
	75	2800	2250	1900	1550	NS	NS	2400	2050	1800	1450	NS	NS
170x58	40	3650	3150	2550	2200	1800	NS	2600	2650	2500	2150	1750	NS
	75	3300	2650	2250	2000	1150	NS	2650	2450	2150	1900	1100	NS
200x58	40	4200	3750	3250	2850	2400	2000	3000	3050	3100	2850	2350	1900
	75	3850	3300	2850	2500	2150	1250	3050	3000	2650	2400	2100	1250
240x58	40	4850	4400	4100	3700	3300	2750	3550	3600	3650	3600	3200	2700
	75	4500	4000	3600	3250	2950	2450	3600	3700	3350	3050	2800	2400
300x58	40	5750	5300	4950	4700	4450	4100	4350	4400	4450	4350	4200	3950
	75	5400	4850	4450	4150	3900	3650	4400	4450	4150	3950	3750	3550
360x58	40	6600	6150	5800	5500	5250	5050	5050	5100	5150	5100	4900	4750
	75	6250	5650	5200	4900	4600	4400	5050	5150	4900	4650	4400	4250
400x58	40	7100	6700	6300	6000	5750	5550	5500	5550	5600	5550	5350	5200
	75	6800	6200	5750	5400	5100	4850	5500	5600	5350	5100	4850	4650
450x58	40	7750	7300	6950	6650	6350	6150	6050	6100	6150	6100	5900	5750
	75	7450	6800	6350	6000	5650	5400	6050	6150	5900	5650	5400	5200
240x75	40	5100	4600	4200	3100	2400	2000	4400	4200	4000	3200	2500	2000
	75	4800	4200	3800	3000	2500	2000	4200	3900	3600	3000	2400	2000
300x75	40	6100	5600	5200	4700	3700	3000	5300	5000	4800	4600	3800	3100
	75	5700	5100	4700	4400	3700	3100	5100	4700	4400	4100	3600	3000
400x75	40	7500	7100	6700	6400	6000	5000	6600	6300	6100	5800	5700	5100
	75	7200	6600	6100	5700	5400	4900	6400	6000	5600	5400	5100	4700
525x75	40	9200	8700	8400	8000	7700	7400	8100	7800	7500	7300	7100	6900
	75	8900	8200	7700	7300	6900	6600	7900	7400	7100	6800	6500	6300
300x82	40	6300	5850	5450	5200	4950	4750	4750	4800	4850	4800	4600	4450
	75	5950	5350	4900	4600	4300	4100	4800	4900	4600	4350	4150	3950
400x82	40	7800	7350	6950	6650	6350	6100	6150	6200	6250	6100	5900	5750
	75	7450	6800	6350	5950	5650	5400	6200	6200	5900	5600	5350	5150

NOTES:

- Sizes in *Italics* are SmartLVL 14
- D = member depth, B = member breadth, NS = not suitable.
- The above table was based on a maximum ceiling mass of 20 kg/m²
- Minimum bearing length = 70 mm at end supports. Subscript values indicate the minimum additional bearing length
- Top edge of strutting/hanging beams with D/B > 3 shall be laterally restrained as per detail on page 5
- Not all sizes of SmartLVL in this table are stocked in each state. Please check with your supplier before ordering. WA only

Ceiling joists AS 4055 wind classification N1-N3 and C1-C3

Ceiling mass 20 kg/m²

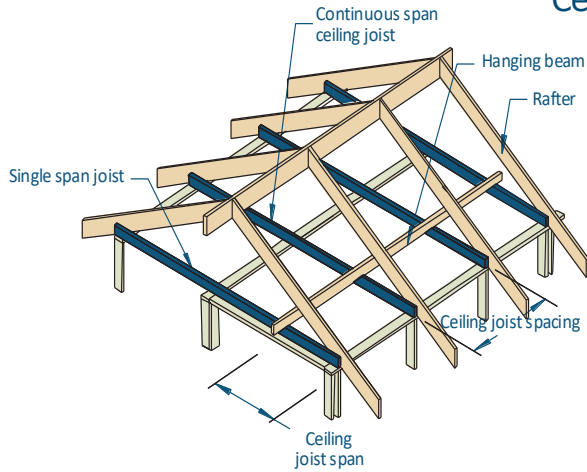

EXAMPLE:

wind speed = N3
ceiling mass = 20 kg/m²
ceiling Joist span = 4500 mm (single span)
ceiling Joist spacing = 450 mm

Enter single span table at 450 mm in joist spacing column, read down to a span equal to or greater than 4500 mm

ADOPT:

SmartLVL 14 - 170x35

Ceiling joist spacing (mm)	450	600	900	1200	450	600	900	1200
Member size DxB (mm)	Maximum recommended single span (mm)				Maximum recommended continuous span (mm)			
<i>90x35</i>	2000	2000	2000	2000	2700	2700	2700	2300
<i>120x35</i>	3100	3100	3100	2900	4100	4100	3800	3200
<i>130x35</i>	3500	3500	3400	3200	4600	4600	4100	3400
<i>140x35</i>	3900	3900	3700	3400	5200	5200	4400	3700
<i>150x35</i>	4300	4300	3900	3600	5800	5700	4700	4000
<i>170x35</i>	5200	4900	4500	4100	6500	6200	5300	4500
<i>200x35</i>	5800	5500	5100	4800	7300	6900	6200	5300
<i>240x35</i>	6500	6200	5800	5400	8200	7800	7300	6300
<i>90x42</i>	2300	2300	2300	2300	3100	3100	3100	2900
<i>120x42</i>	3600	3600	3500	3200	4700	4700	4500	3800
<i>130x42</i>	4000	4000	3700	3400	5300	5300	4900	4100
<i>140x42</i>	4500	4500	4000	3700	6000	5700	5200	4400
<i>150x42</i>	5000	4800	4300	3900	6300	6000	5500	4700
<i>170x42</i>	5500	5200	4800	4500	6900	6500	6000	5300
<i>200x42</i>	6100	5800	5400	5100	7700	7300	6800	6200
<i>240x42</i>	6900	6600	6100	5800	8600	8200	7700	7300
<i>300x42</i>	7900	7600	7100	6700	10000	9600	8900	8500
<i>90x58</i>	2700	2700	2700	2600	3600	3600	3600	3300
<i>130x58</i>	4700	4500	4100	3800	6100	5800	5300	4700
<i>150x58</i>	5300	5100	4700	4300	6700	6400	5900	5400
<i>170x58</i>	5800	5500	5100	4800	7200	6900	6400	6000
<i>200x58</i>	6400	6100	5700	5400	8100	7700	7200	6800
<i>240x58</i>	7200	6900	6500	6100	9000	8700	8100	7700
<i>300x58</i>	8200	8000	7500	7200	10400	10000	9400	9000
<i>360x58</i>	9200	8900	8400	8100	11600	11200	10600	10200
<i>400x58</i>	9800	9500	9000	8700	12000	12000	11400	10900
<i>450x58</i>	10500	10200	9700	9400	12000	12000	12000	11800
<i>240x75</i>	7400	7100	6700	6400	9300	9000	8500	8100
<i>300x75</i>	8500	8200	7800	7500	10700	10300	9800	9400
<i>400x75</i>	10000	9800	9300	9000	12000	12000	11800	11300
<i>525x75</i>	10800	10500	10000	9700	12000	12000	12000	12000
<i>300x82</i>	8600	8300	7900	7600	10800	10400	9900	9500
<i>400x82</i>	10100	9900	9400	9100	12000	12000	11900	11500

NOTES:

- Sizes in *Italics* are SmartLVL 14
- D = member depth, B = member breadth
- Do not walk on joists during construction unless a construction plank is in place
- Minimum end/internal bearing length of 70 mm
- Not all sizes of SmartLVL in this table are stocked in each state. Please check with your supplier before ordering. WA only

SmartSplay® 15 roof void beams

Introduction

The need to chamfer the ends of roof beams to avoid interference with roof cladding requires consideration by designers.

Where the slope of rafters is such that the depth of the beam must be reduced by more than two-thirds, special provision shall be made for additional support.

Figure 7.3 from AS 1684 (reproduced opposite) gives a “deemed to comply” solution to the reinforcement of the roof beam by the addition of a Jack Joist (trimmer) to the underside of the roof beam. The additional requirement is for the roof beam to be bolted to the rafter and the jack joist fastened to the roof beam with a timber cleat or metal strap. The standard however does not give guidance on the size of any timber cleats or metal straps.

The introduction of LVL with its inherent strength properties and length availability combined with existing claw nail plate technology allows the prefabrication of SmartSplay roof-void beams with the jack joist (trimmer) in the above diagram nail plated together prior to installation.

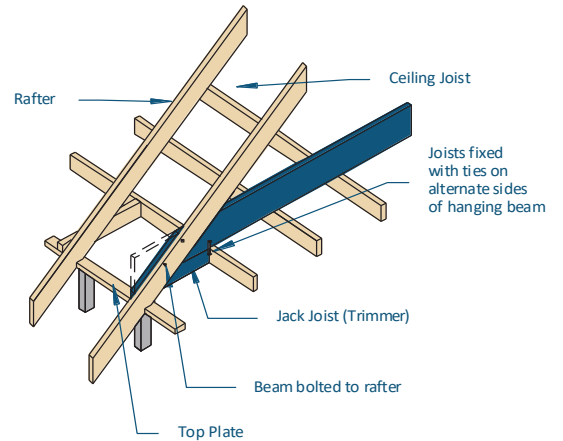
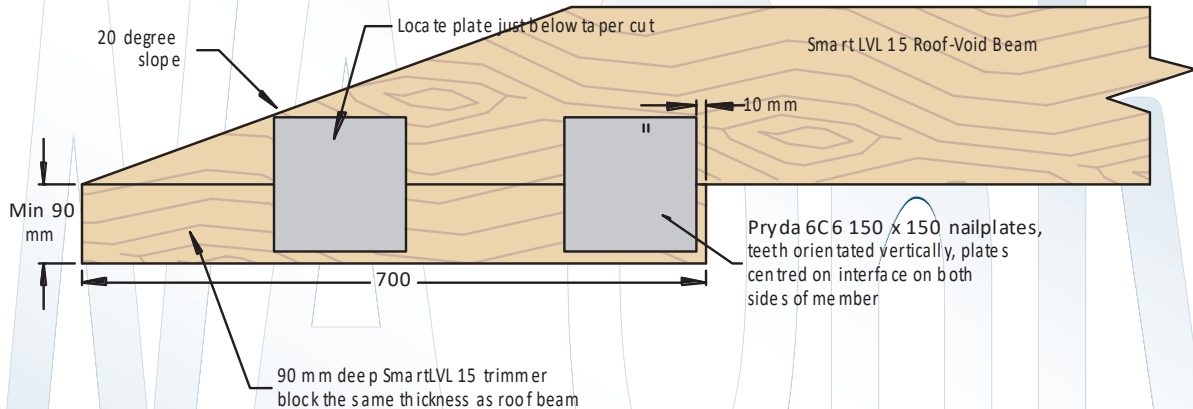

Figure 7.3 AS 1684.2

SmartSplay® 15 roof void beam



The SmartSplay 15 roof void beam is available from SmartFrame stockists in length multiples of 300 mm.

Basis of tables

The following tables have been prepared for the common applications for pre-fabricated SmartSplay 15 Roof-void beams in the Western Australian domestic residential market. The mechanical properties of the SmartLVL Roof-void beam have been developed using standard engineering principles and full scale prototype tests in accordance with Appendix D of AS 1720.1 - Acceptance testing of timber structures and elements.

Construction detailing

The roof construction detailing of the pre-fabricated SmartSplay roof-void beam are the same as for non-chamfered roof beams, and must be installed and restrained in accordance with AS 1684 and good building practice. Restraint examples suitable for SmartLVL Roof-void beams are shown on page 5.

Limitations of use

The tables for the SmartSplay 15 Roof-void beams are specific to the use clearly shown. The use of a SmartSplay 15 Roof-void beam in any other application (e.g. floor joists) is outside the scope of this Design Guide. SmartSplay 15 Roof-void beams may have applications in other areas but prospective users should contact Tilling Timber on 1300 668 690 or techsupport@tilling.com.au for further engineering advice.

SmartSplay 15 strutting beams supporting underpurlins ONLY AS 4055 wind classification N1 - N4

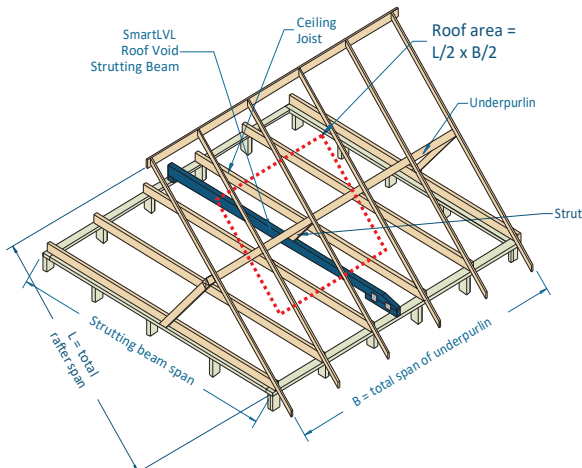

EXAMPLE:

single span
sheet roof
strutting beam span = 4500 mm
total of underpurlin span B = 4.5 m
total of rafter span L = 4.0 m
roof area supported = $L/2 \times B/2 = 4.0/2 \times 4.5/2 = 4.5 \text{ m}^2$

Enter table at 5 m^2 roof area supported column and read down to span equal to or greater than 4500 mm

ADOPT

SmartSplay 15 Roof-void beam
200 x 58

Roof area supported (m^2)	2	3	4	5	6	7	8	10
Size DxB (mm)	Maximum recommended roof strutting beam span (mm)							
SHEET roof								
150x42	3900	3700	3200	2900	2700	2500	2300	2100
150x58	4600	4200	3700	3400	3100	2900	2700	2400
2/150x35	5000	4500	4000	3700	3400	3100	3000	2700
170x42	4700	4400	3800	3500	3200	3000	2800	2500
170x58	5400	5000	4400	4000	3700	3500	3200	2900
200x58	6300	6000	5500	5000	4700	4400	4100	3700
2/200x35	6600	6300	5900	5400	5000	4700	4500	4000
2/200x42	6600	6500	6200	5800	5400	5100	4800	4400
240x58	6600	6600	6600	6200	5900	5600	5300	4500
2/240x35	6600	6600	6600	6500	6200	6000	5700	5200
2/240x42	6600	6600	6600	6600	6500	6300	6100	5600
300x58	6600	6600	6600	6600	6600	6600	6600	5300
300x75	6600	6600	6600	6600	6600	6600	6600	4900
300x82	6600	6600	6600	6600	6600	6600	6600	4800
360x58	6600	6600	6600	6600	6600	6600	6600	6100
400x58	6600	6600	6600	6600	6600	6600	6600	6500
400x75	6600	6600	6600	6600	6600	6600	6600	6000
400x82	6600	6600	6600	6600	6600	6600	6600	5800
450x58	6600	6600	6600	6600	6600	6600	6600	6600
TILE roof								
150x42	3000	2500	2100	1900	1700	1600	1500	NS
150x58	3500	2900	2500	2200	2000	1900	1700	NS
2/150x35	3800	3100	2700	2500	2200	2100	1900	1700
170x42	3600	3000	2600	2300	2100	1900	1800	NS
170x58	4100	3400	3000	2700	2500	2300	1900	NS
200x58	5100	4300	3800	3400	3100	2900	2200	1500
2/200x35	5500	4700	4200	3800	3400	3200	3000	2700
2/200x42	5900	5100	4500	4100	3800	3500	3300	2900
240x58	6300	5600	5000	4500	4100	3700	2600	1800
2/240x42	6600	6300	5800	5300	4900	4500	4300	3900
300x58	6600	6600	6400	6100	5600	4400	3200	2200
300x75	6600	6600	6600	6500	6200	4100	3100	2200
300x82	6600	6600	6600	6600	6100	4000	3000	2100
360x58	6600	6600	6600	6600	6600	5000	3700	2600
400x58	6600	6600	6600	6600	6600	5400	4100	2900
400x75	6600	6600	6600	6600	6600	5000	3900	2800
400x82	6600	6600	6600	6600	6600	4800	3800	2700
450x58	6600	6600	6600	6600	6600	5700	4500	3200

NOTES

Roof void chamfer on one end only

- Minimum end bearing length = 70 mm
- Top edge of strutting beams with $D/B > 3$ shall be laterally restrained as per details on page 5
- A minimum initial clearance of 25 mm at mid span to ceiling framing members should be provided

SmartSplay 15 strutting / hanging beams supporting underpurlins & ceiling joists AS 4055 wind classification N1, N2 and N3

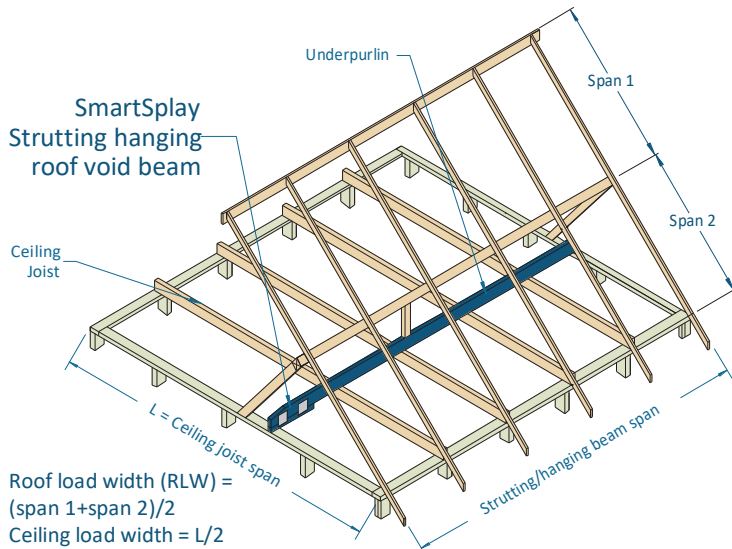

EXAMPLE:

single span
sheet roof
strutting / hanging beam span = 3500 mm
total ceiling joist span A = 6000 mm
ceiling load width = $A / 2 = 3000$ mm
span 1 = 3 m
span 2 = 4 m
roof load width = $(3+4) / 2 = 3.5$ m

Enter table at 3000 mm ceiling load width, 3.6 m roof load width and read down to span equal to or greater than 3500 mm

ADOPT

SmartSplay 15 Roof-void beam
200 x 58 or 2/170 x 42

Ceiling load width (mm)	2400				3000				4200			
Roof load width (m)	1.8	2.4	3.0	3.6	1.8	2.4	3.0	3.6	1.8	2.4	3.0	3.6
Size DxB (mm)	Maximum recommended strutting/hanging beam span (mm)											
	Sheet Roof											
2/170x42	4200	4100	4000	3900	4000	3900	3800	3800	3700	3600	3600	3500
200x58	4400	4300	4200	4100	4200	4100	4000	3900	3800	3700	3700	3600
2/200x35	4600	4500	4400	4300	4400	4300	4200	4100	4000	3900	3900	3800
2/200x42	4800	4700	4600	4500	4500	4500	4400	4300	4200	4100	4000	4000
240x42	4700	4500	4400	4300	4400	4300	4200	4200	4100	4000	3900	3900
240x58	5000	4900	4800	4700	4800	4700	4600	4500	4400	4300	4300	4200
2/240x42	5500	5400	5300	5200	5200	5100	5000	5000	4800	4700	4700	4600
300x58	6000	5900	5800	5700	5700	5600	5500	5400	5200	5100	5100	5000
300x75	6300	6200	6100	6000	6000	5900	5800	5800	5500	5500	5400	5300
300x82	6400	6300	6200	6100	6100	6000	6000	5900	5600	5600	5500	5500
360x58	6600	6600	6600	6500	6500	6400	6300	6200	6000	5900	5800	5800
400x58	6600	6600	6600	6600	6600	6600	6600	6600	6500	6400	6300	6300
400x75	6600	6600	6600	6600	6600	6600	6600	6600	6600	6600	6600	6600
400x82	6600	6600	6600	6600	6600	6600	6600	6600	6600	6600	6600	6600
450x58	6600	6600	6600	6600	6600	6600	6600	6600	6600	6600	6600	6600
	Tile Roof											
170x58	3400	3200	3000	2800	3300	3000	2900	2700	3000	2800	2700	2600
2/170x35	3600	3400	3200	3000	3500	3300	3100	2900	3200	3000	2900	2800
2/170x42	3800	3600	3500	3300	3700	3500	3300	3200	3400	3200	3100	3000
200x58	4000	3800	3600	3500	3800	3700	3500	3400	3600	3400	3300	3100
2/200x35	4200	4000	3800	3700	4000	3900	3700	3600	3800	3600	3500	3400
2/200x42	4400	4200	4000	3900	4200	4100	3900	3800	3900	3800	3700	3600
240x58	4600	4400	4300	4100	4500	4300	4100	4000	4100	4000	3900	3800
2/240x42	5100	4900	4700	4600	4900	4700	4600	4400	4600	4400	4300	4200
300x58	5600	5400	5200	5000	5300	5200	5000	4900	5000	4800	4700	4600
300x75	5900	5700	5500	5400	5700	5500	5400	5200	5300	5200	5000	4900
300x82	6000	5800	5700	5500	5800	5600	5500	5300	5400	5300	5200	5100
360x58	6400	6200	6000	5900	6200	6000	5800	5700	5700	5600	5500	5400
400x58	6600	6600	6600	6400	6600	6500	6400	6200	6200	6100	6000	5900
400x75	6600	6600	6600	6600	6600	6600	6600	6600	6600	6500	6400	6200
450x58	6600	6600	6600	6600	6600	6600	6600	6600	6600	6600	6500	6400

NOTES

Roof void chamfer on one end only

- i. Minimum end bearing length = 70 mm.
- ii. Top edge of strutting beams with D/B > 3 shall be laterally restrained as per details on page 5

SmartSplay 15 Counter beams supporting hanging beams AS 4055 wind classification N1, N2, and N3

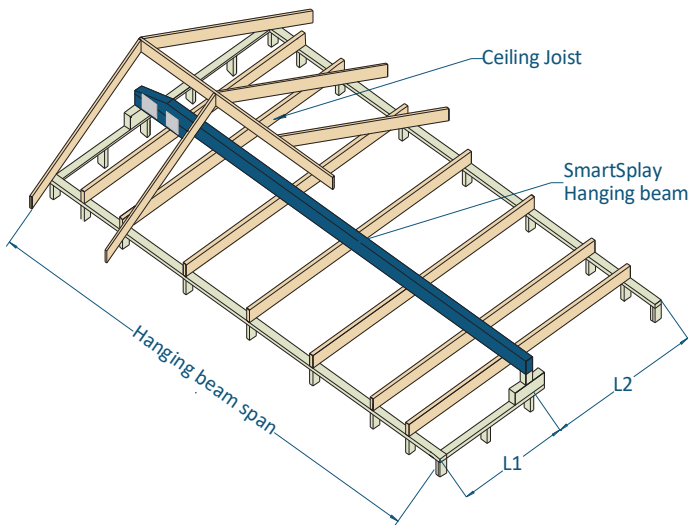

EXAMPLE:

single span
counter beam span = 5500
total of hanging beam span $L1 + L2 = 6400$ mm
Average hanging beam span = $6400/2 = 3200$ mm

Enter table at 3600 mm load width column and read down to span equal to or greater than 5500 mm

ADOPT

SmartSplay 15 roof void beam
240 x 58

Average hanging beam span (mm)	2400	3000	3600	4200	4800	5400	6000	6600
Size DxB (mm)	Maximum recommended counter beam span (mm)							
150x35	3600	3300	3100	2900	2800	2700	2600	2500
150x42	3800	3500	3300	3100	3000	2900	2800	2700
170x35	4000	3700	3500	3300	3200	3100	3000	2900
170x42	4300	4000	3700	3600	3400	3300	3200	3100
200x35	4700	4400	4200	3900	3800	3600	3500	3400
200x42	4900	4600	4400	4200	4000	3900	3700	3600
200x58	5300	5000	4800	4600	4500	4300	4100	4000
240x35	5400	5100	4800	4700	4500	4400	4200	4100
240x42	5600	5300	5100	4900	4700	4600	4500	4300
240x58	6100	5800	5500	5300	5100	5000	4800	4700
300x42	6600	6300	6000	5800	5600	5400	5300	5200
300x58	6600	6600	6500	6300	6100	5900	5700	5600
300x75	6600	6600	6600	6600	6500	6300	6100	6000
300x82	6600	6600	6600	6600	6600	6400	6300	6100
360x58	6600	6600	6600	6600	6600	6600	6600	6400
400x58	6600	6600	6600	6600	6600	6600	6600	6600
400x75	6600	6600	6600	6600	6600	6600	6600	6600
400x82	6600	6600	6600	6600	6600	6600	6600	6600
450x58	6600	6600	6600	6600	6600	6600	6600	6600

NOTES

Roof void chamfer on one end only

- i. Minimum end bearing length = 70 mm
- ii. Top edge of strutting beams with $D/B > 3$ shall be laterally restrained as per details on page 5

SmartPlay 15 strutting/counter beams supporting underpurlins and hanging beams

AS 4055 wind classification N1, N2 and N3

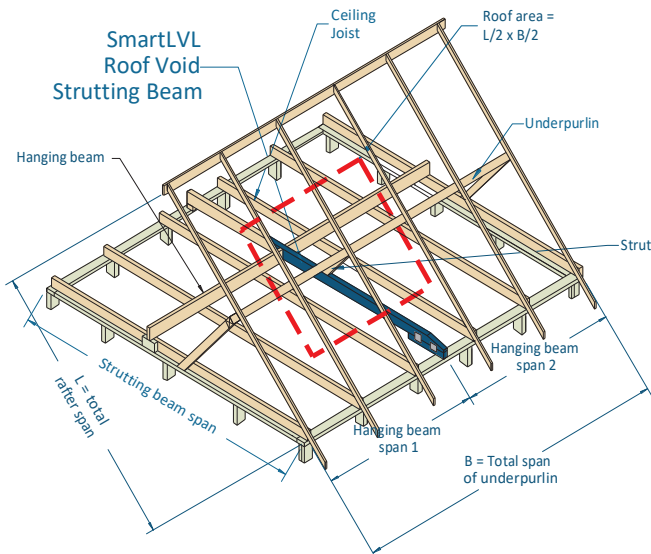

EXAMPLE:

single span
sheet roof
strutting/counter beam span = 3500 mm
total of underpurlin span B = 4.5 m
total of rafter span L = 4.0 m
total of hanging beam span = H1 + H2 = 4500 mm
roof area supported = $L/2 \times B/2 = (4/2) \times (4.5/2) = 4.25 \text{ m}^2$
average hanging beam span = $(H1 + H2)/2 = 4500/2 = 2250 \text{ mm}$

Enter table at 2400 mm average hanging beam span column, 6 m² roof area supported and read down to span equal to or greater than 3500 mm

ADOPT

SmartPlay 15 Roof-void beam
200 x 58 or 2/170 x 35

Average hanging beam span (mm)	2400					4200				
Roof area supported (m ²)	2	4	6	8	10	2	4	6	8	10
Size DxB (mm)	Maximum recommended strutting/counter beam span (mm)									
	Sheet Roof									
170x58	3900	3600	3200	2900	2700	3600	3300	3000	2800	2600
2/170x35	4100	3800	3500	3200	2900	3800	3500	3200	3000	2800
2/170x42	4300	3900	3700	3400	3200	3900	3700	3500	3200	3000
200x58	4500	4100	3800	3600	3400	4100	3800	3600	3400	3200
2/200x35	4700	4300	4000	3800	3600	4300	4000	3800	3600	3400
2/200x42	4800	4500	4200	4000	3800	4400	4200	4000	3800	3700
240x58	5100	4800	4500	4200	4000	4700	4400	4200	4000	3900
2/240x42	5500	5200	4900	4700	4500	5100	4800	4600	4400	4300
300x58	6000	5700	5400	5100	4900	5500	5300	5000	4900	4700
300x75	6400	6000	5700	5500	5300	5800	5600	5400	5200	5000
300x82	6500	6100	5900	5600	5400	5900	5700	5500	5300	5100
360x58	6600	6500	6200	6000	5800	6300	6000	5800	5600	5500
400x58	6600	6600	6600	6500	6300	6600	6500	6300	6100	5900
400x75	6600	6600	6600	6600	6600	6600	6600	6600	6500	6300
400x82	6600	6600	6600	6600	6600	6600	6600	6600	6600	6500
450x58	6600	6600	6600	6600	6600	6600	6600	6600	6600	6500
	Tile Roof									
170x58	3500	2800	2400	2100	1900	3200	2600	2300	2000	1800
2/170x35	3700	3000	2600	2300	2000	3400	2900	2500	2200	2000
2/170x42	3800	3300	2800	2500	2200	3600	3100	2700	2400	2200
200x58	4000	3400	3000	2600	2400	3700	3300	2800	2600	2300
2/200x35	4200	3700	3200	2900	2600	3900	3500	3100	2800	2500
2/200x42	4400	3900	3500	3100	2800	4100	3700	3300	3000	2800
240x58	4700	4100	3700	3400	3100	4300	3900	3600	3300	3000
2/240x42	5100	4500	4200	3900	3600	4800	4300	4000	3800	3600
300x58	5600	5000	4600	4300	4000	5200	4700	4400	4100	3900
300x75	5900	5300	4900	4600	4300	5500	5100	4700	4500	4200
300x82	6000	5500	5000	4700	4400	5600	5200	4800	4600	4300
360x58	6400	5800	5400	5000	4800	6000	5500	5200	4900	4600
400x58	6600	6400	5900	5500	5200	6500	6000	5600	5300	5100
400x75	6600	6600	6300	5900	5600	6600	6400	6000	5700	5500
400x82	6600	6600	6500	6100	5800	6600	6500	6200	5900	5600
450x58	6600	6600	6500	6100	5800	6600	6600	6200	5900	5700

NOTES

Roof void chamfer on one end only

- i. Minimum end bearing length = 70 mm
- ii. Top edge of strutting beams with D/B > 3 shall be laterally restrained as per details on page 5

Pryda® WA Beam Hanger



Pryda WA Beam hangers are heavy duty welded hangers for connection of large sized strutting beams placed at angles between 30 and 60 degrees. This bracket is specially developed for the Western Australian market and are available as part of the SmartFrame order.

All fixings are No 12 x 35 Type 17 hex-head screws and capacities shown adjacent are based upon a minimum joint strength group of JD4.

Design capacities

Load Direction	Capacity (kN)
Downward	15.0
Uplift (light fixing)	4.0
Uplift (medium fixing)	10.0
Uplift (heavy fixing)	20.0

Order code BBT125240 or WABBT

Light fixing

Supporting beam:
3 screws on top

Supported beam:
2 screws into bottom

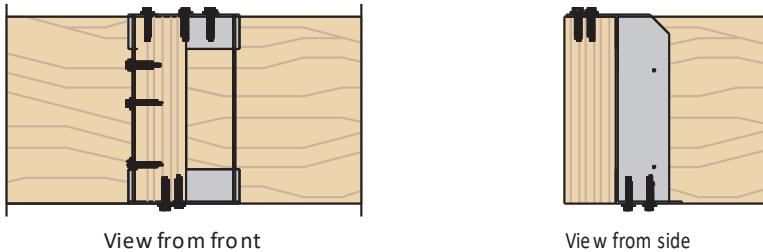

View from front

View from side

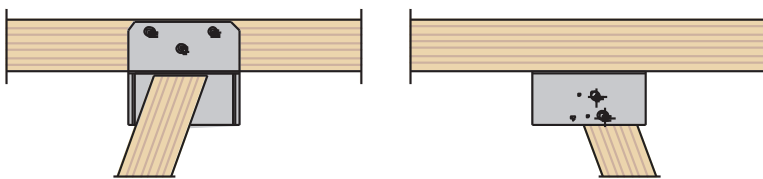

View from top

View from underneath

Option 1

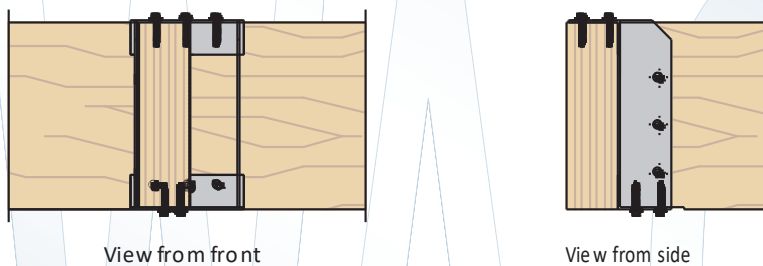

View from front

View from side

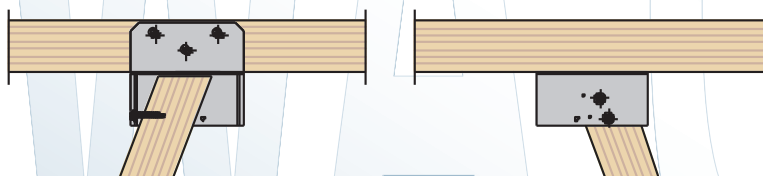

View from top

View from underneath

Option 2

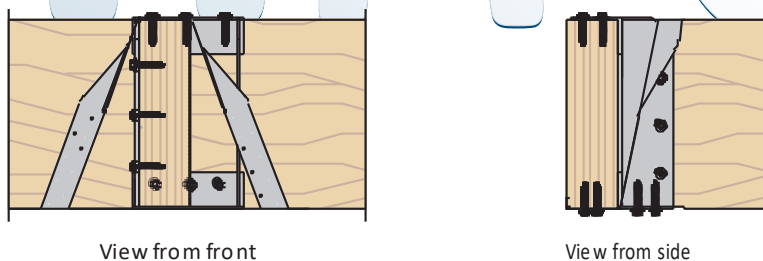

View from front

View from side

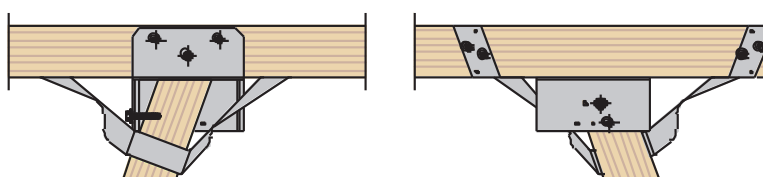

View from top

View from underneath

Option 3

Medium fixing

Supporting beam:
3 screws on top and 3 screws through side

Supported beam:
3 screws from side
2 screws into bottom

Heavy fixing

Medium fixing in combination with a cyclonic strap

SmartLVL 12

Underpurlins – sheet and tiled roof AS 4055 wind classification N1, N2, N3 and C1

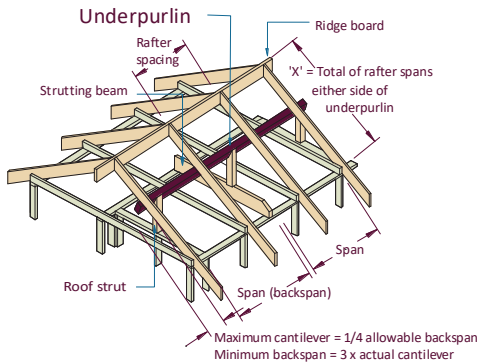

RLW = X/2 where ridge is struttred

EXAMPLE:

single span
sheet roof - 20 kg/m²
rafter spacing = 1200 mm
Underpurlin span = 1800 mm
X = 2800 mm
roof load width = X/2 = 1400
Enter single span table at 1800 roof load width column, 1200 rafter spacing and read down to span equal to or greater than 1800 mm

ADOPT

SmartLVL 12

96 x 51

Roof load width (mm)		1800		2700		3000		3600		1800		2700		3000		3600	
Rafter spacing (mm)		600	1200	600	1200	600	1200	600	1200	600	1200	600	1200	600	1200	600	1200
Member size DxB (mm)	Roof mass (kg/m ²)	Single span								Continuous span							
		96x51	10	2800	2800	2400	2400	2300	2200	2100	1900	3000	3000	2500	2600	2300	2500
	20	2300	2300	2000	2000	1900	1900	1800	1800	3100	3000	2600	2600	2500	2600	2200	2200
	40	1800	1800	1600	1500	1500	1400	1400	1300	2500	2500	2100	2100	2100	2000	1900	1900
	60	1600	1500	1400	1200	1300	1100	1300	1000	2100	2100	1900	1800	1800	1800	1700	1500

NOTES:

End bearing lengths = 45 mm at end supports and 45 mm at internal for continuous members.

Roof struts – sheet and tiled roof AS 4055 wind classification N1, N2, N3 and C1

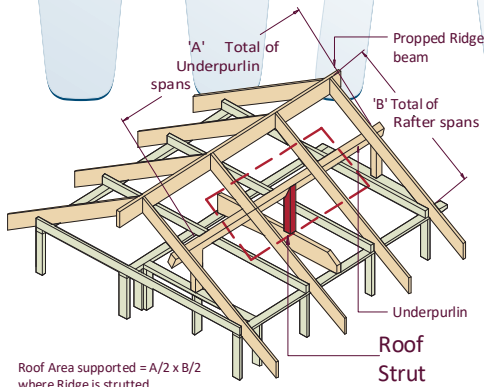

EXAMPLE:

sheet roof - 20 kg/m²
strut length = 1500 mm
total of underpurlin span A = 4.5 m
total of rafter span B = 4.0 m
roof area supported = A/2 x B/2 =
4.5/2 x 4.0/2 = 4.25 m²
Enter table at 5.4 roof area supported column and read down to span equal to or greater than 1500 mm

NOTE: See fixing details of SmartLVL 12 roof struts on page 6

ADOPT

SmartLVL 12

65 x 63

Roof area supported (m ²)		4	5.4	6	8	10	12
Member size DxB (mm)	Roof mass (kg/m ²)	Maximum Strut length (mm)					
		65x63	10	6800	5900	5600	4800
	20	6400	5500	5200	4500	4000	3700
	40	5600	4900	4600	4000	3600	3200
	60	4700	4100	3900	3300	3000	2700

NOTES:

- Tables assume strut is vertical. Struts lengths will reduce with increased angle from the vertical
- D = member depth, B = member breadth, NS = not suitable.
- Minimum bearing length = 70 mm at end supports
- The strutting tables in AS 1684 are based upon the load associated with an underpurlin span of 1.8 m and a roof load width of 3.0 m. To compare to AS 1684.2 Table 7.6, use a roof area of 5.4 m² in the above table
- Fixing of SmartLVL roof struts as per detail on page 5

SMARTFRAME[®]

POWERED BY INNOVATION

Head Office

Victoria

31-45 Orchard Street,
Kilsyth Vic 3137

email: sales@tilling.com.au

Phone +61 3 9725 0222

Fax +61 3 9725 3045

New South Wales

109 Kurrajong Avenue,
Mt Druitt, NSW 2770

email: nswsales@tilling.com.au

Phone +61 2 9677 2600

Fax +61 2 9677 2500

Queensland

84 Magnesium Drive,
Crestmead QLD 4132

email: qldsales@tilling.com.au

Phone +61 7 3440 5400

Fax +61 7 3440 5444

Western Australia

10 Cartwright Drive
Forrestdale WA 6112

email: wasales@tilling.com.au

Phone +61 8 9399 1609

Fax +61 8 9399 1065

South Australia

5-9 Woomera Ave
Edinburgh SA 5111

email: sasales@tilling.com.au

Phone +61 8 8345 1966

Fax +61 8 8345 1977

Sales 1800 33 77 03

Technical support 1300 66 86 90

